

CHINT
CHINT ELECTRIC

Fiyat Listesi
Eylül 2020



DÜNYADA CHNT

- 3 Dünya Çapında AR&GE Merkezi: Avrupa, Kuzey Amerika, Asya Pasifik
- 6 Uluslararası Pazarlama & Satış Alanı: Asya Pasifik, Orta Doğu ve Afrika, Avrupa, Latin Amerika, Kuzey Amerika, Çin
- 9 Üretim Tesisi: Çin (Wenzhou, Shanghai, Hangzhou, Xianyang, Jiuquan), Mısır, Almanya, Tayland
- 14 Uluslararası İştirak
- 17 Pazarlama Ofisi
- 22 Lojistik Merkezi
- 2300 Satış Şirketi



Ürünlerimizin sahip olduğu uluslararası sertifikalar:

TURKEY	EU	Netherland	Germany	Germany	Sweden	Finland	Czech	Indonesia	Ukraine	Russia	South Africa	USA	Canada	UK





eb Serisi Otomatik Sigortalar	2-3
NXB ve NB7 Serisi Otomatik Sigortalar	4-5
NB1 Serisi Otomatik Sigortalar	6
DZ158 Serisi Otomatik Sigortalar	7
NB1, NXB ve DZ158 Serileri Yardımcı Aksesuarlar	7
NL1 Serisi Kaçak Akım Koruma Röleleri RCCB	8-9
NB1L Kaçak Akım Korumalı Otomatik Sigortalar - RCBO	10
NU6 B,C,D Sınıfı Alçak Gerilim Parafudr	11-12
Fotovoltaik Sistem Ürünleri	13-14
NJMC1 Darbe Akım Anahtarları	15
NCH8 Serisi Bina İçi Aydınlatma/Otomasyon Kontaktörü	15
NTE8 Serisi LEDli Elektronik Zaman Rölesi	16
NKG3 Dijital Zaman Saati	16
KG316T Dijital Zaman Saati	16
NH4 Din Ray Tip Yük Ayırıcı	17
NRT28-32 Kartuş ve Sigorta Yuvaları (gG/gL Hızlı Tip Sigorta)	17
NHRT40 Dikey Yük Ayırıcı	18
NH40 Serisi Yük Ayırıcıları	18
NXZ Serisi Otomatik Transfer Şalterleri	19
NXM Serisi Kompakt Tip Devre Kesiciler	21
NXM Serisi Devre Kesiciler için Yardımcı Aksesuarlar	22
NM8 Serisi Kompakt Tip Ayarlı Devre Kesiciler	23 -24
NM8 Serisi Sadece Manyetik Korumalı Devre Kesiciler	24
NM8 Serisi Alçak Gerilim Devre Kesici için Aksesuarlar	25
NXMLE Serisi Kaçak Akım Algılamalı Kompakt Tip Devre Kesiciler	26
NM8L Kaçak Akım Korumalı Devre Kesiciler	26
NA1-X Serisi Açık Tip Devre Kesiciler ve Aksesuarları	28
NA8G Serisi Açık Tip Devre Kesiciler	29
Kaçak Akım Algılama Röleleri ve Toroidler	30
AG Kuru ve Silindirik Tip Kondansatörler	31
Şönt Reaktörler ve Endüktif Yük Sürücüler	32
CJ19 Serisi Kompanzasyon Kontaktörleri	33
Harmonik Filtre Reaktörleri	33
NXC Serisi 1NA+1NK Kontaktörler	35
NC1 Serisi Kontaktörler	35-36
NC1 Serisi Kontaktörler Aksesuarları	37
NC2 Serisi Kontaktörler ve Aksesuarları	38
NC1 ve NC2 Uyumlu Termik Röleler	39
NXC Uyumlu Termik Röleler	39
Mini Kontaktörler	40
NS2 Serisi Motor Koruma Şalterleri	41
NQ3 Serisi Kutulu Yolvericiler	42
NJDC Endüstriyel Röle ve Soketleri	43
ND16 Plastik Seri Sinyal Lambası (LED)	44
NP2 Serisi 22mm Metal Seri Buton ve Sinyal Lambası	45
NP2 Serisi 22mm Plastik Seri Buton ve Sinyal Lambası	46
NP8 Serisi 22mm Krom Gövde Seri Buton ve Sinyal Lambası	47
NP2 Kutular	48
MRT11 Serisi Röleler	49
CSL Serisi Pako Şalterler	50-52
CSX Serisi Pako Şalterler	53-55
Sigorta Kutuları	56

ÖNEMLİ NOTLAR

- Fiyatlarımıza her an ihbara gerek duymaksızın değişiklik yapma hakkımız saklıdır.
- Teslim tarihindeki liste fiyatlarımız faturalamaya esastır.
- Fiyatlarımıza KDV dahil değildir.
- Listemiz dışındaki ürünler için tarafımızla temasa geçiniz.
- Resimler ve teknik veriler sadece bilgi amaçlıdır.
- Uygulamalarınızda kullanım kılavuzlarına riayet ediniz.





eB Serisi Otomatik Sigortalar

4.5 kA B | Hızlı Karakterli

	In (A) 230/400 V AC 50/60 Hz	Sipariş Kodu	Birim Fiyat (₺)	Kutu Adeti
1 Kutup 	1	186423	25,87	12
	2	186424	22,38	12
	3	186425	25,87	12
	4	186426	25,87	12
	6	186428	21,48	12
	10	186429	20,27	12
	16	186430	20,27	12
	20	186431	20,27	12
	25	186432	20,27	12
	32	186433	24,14	12
	40	186434	26,55	12
	50	186577	30,17	12
	63	186997	32,58	12
	2 Kutup 	1	186447	55,51
2		186448	55,51	6
3		186449	55,51	6
4		186450	57,93	6
6		186452	55,51	6
10		186453	49,89	6
16		186454	49,89	6
20		186455	49,89	6
25		186456	49,89	6
32		186457	56,12	6
40		186458	59,62	6
50		186571	62,15	6
63		187002	63,36	6
3 Kutup 		1	186507	89,29
	2	186508	89,29	4
	3	186509	89,29	4
	4	186510	89,29	4
	6	186512	89,29	4
	10	186513	76,02	4
	16	186514	76,02	4
	20	186515	76,02	4
	25	186516	76,02	4
	32	186517	83,27	4
	40	186518	85,68	4
	50	186562	100,60	4
	63	186996	111,70	4
	4 Kutup 	1	186519	114,70
2		186520	114,70	3
3		186521	114,70	3
4		186522	114,70	3
6		186524	114,70	3
10		186525	98,94	3
16		186526	98,94	3
20		186527	98,94	3
25		186528	98,94	3
32		186529	105,90	3
40		186530	122,90	3
50		186559	132,90	3
63		187003	150,10	3

eB Serisi Otomatik Sigortalar

4.5 kA C | Yavaş Karakterli

	In (A) 230/400 V AC 50/60 Hz	Sipariş Kodu	Birim Fiyat (₺)	Kutu Adeti
1 Kutup 	1	186411	22,95	12
	2	186412	22,95	12
	3	186413	22,95	12
	4	186414	22,95	12
	6	186416	22,87	12
	10	186417	20,27	12
	16	186418	20,27	12
	20	186419	20,27	12
	25	186420	20,27	12
	32	186421	24,14	12
	40	186422	26,55	12
	50	186576	30,17	12
	63	185639	31,98	12
	2 Kutup 	1	186459	63,08
2		186460	61,88	6
3		186461	61,88	6
4		186462	61,88	6
6		186464	53,69	6
10		186465	52,22	6
16		186466	52,22	6
20		186467	52,22	6
25		186468	52,22	6
32		186469	56,96	6
40		186470	60,58	6
50	186570	63,46	6	
63	185640	70,99	6	
3 Kutup 	1	186495	96,54	4
	2	186496	96,54	4
	3	186497	96,54	4
	4	186498	96,54	4
	6	186500	79,64	4
	10	186501	74,22	4
	16	186502	74,22	4
	20	186503	74,22	4
	25	186504	74,22	4
	32	186505	82,06	4
	40	186506	86,20	4
50	186561	97,45	4	
63	185641	109,30	4	
4 Kutup 	1	186531	117,30	3
	2	186532	117,30	3
	3	186533	117,30	3
	4	186534	117,30	3
	6	186536	107,50	3
	10	186537	103,40	3
	16	186538	103,40	3
	20	186539	103,40	3
	25	186540	103,40	3
	32	186541	111,10	3
	40	186542	123,10	3
50	186557	132,90	3	
63	186804	150,10	3	

6 kA Otomatik Sigortalar

B | Hızlı Karakterli



NXB	In (A) 230/400 V AC 50/60 Hz	NXB		NB7		Kutu Adeti	NB7
		Sipariş Kodu	Birim Fiyat (₺)	Sipariş Kodu	Birim Fiyat (₺)		
1 Kutup	1	814034	32,17	192160	32,93	12	1 Kutup
	2	814035	32,17	192161	32,93	12	
	3	814036	32,17	192162	32,93	12	
	4	814037	32,17	192163	32,93	12	
	6	814038	28,35	192164	29,02	12	
	10	814039	23,39	192165	23,94	12	
	16	814040	23,39	192166	23,94	12	
	20	814041	23,39	192167	23,94	12	
	25	814042	23,39	192168	23,94	12	
	32	814043	27,69	192169	28,34	12	
	40	814044	30,71	192170	31,43	12	
	50	814045	34,54			12	
	63	814046	35,66			12	
	2 Kutup	1	814112	70,87	192199	72,54	
2		814113	70,87	192200	72,54	6	
3		814114	70,87	192201	72,54	6	
4		814115	70,87	192202	72,54	6	
6		814116	64,37	192203	65,89	6	
10		814117	59,06	192204	60,45	6	
16		814118	59,06	192205	60,45	6	
20		814119	59,06	192206	60,45	6	
25		814120	60,24	192207	61,66	6	
32		814121	68,51	192208	70,12	6	
40		814122	70,87	192209	72,54	6	
50		814123	78,00			6	
63		814124	80,23			6	
3 Kutup		1	814190	102,80	192238	105,20	4
	2	814191	102,80	192239	105,20	4	
	3	814192	102,80	192240	105,20	4	
	4	814193	102,80	192241	105,20	4	
	6	814194	98,69	192242	101,10	4	
	10	814195	85,04	192243	87,05	4	
	16	814196	85,04	192244	87,05	4	
	20	814197	85,04	192245	87,05	4	
	25	814198	86,22	192246	88,26	4	
	32	814199	99,22	192247	101,60	4	
	40	814200	120,20	192248	123,00	4	
	50	814201	128,20			4	
	63	814202	139,30			4	
	4 Kutup	1	814268	141,80	192277	145,10	3
2		814269	141,80	192278	145,10	3	
3		814270	141,80	192279	145,10	3	
4		814271	141,80	192280	145,10	3	
6		814272	132,30	192281	135,40	3	
10		814273	118,20	192282	121,00	3	
16		814274	118,20	192283	121,00	3	
20		814275	118,20	192284	121,00	3	
25		814276	118,20	192285	121,00	3	
32		814277	135,90	192286	139,10	3	
40		814278	141,80	192287	145,10	3	
50		814279	152,70			3	
63		814280	167,20			3	

6 kA Otomatik Sigortalar

C | Yavaş Karakterli







NXB	In (A) 230/400 V AC 50/60 Hz	NXB		NB7		Kutu Adeti	NB7
		Sipariş Kodu	Birim Fiyat (₺)	Sipariş Kodu	Birim Fiyat (₺)		
1 Kutup	1	814008	32,50	192173	33,26	12	1 Kutup
	2	814009	32,50	192174	33,26	12	
	3	814010	32,50	192175	33,26	12	
	4	814011	32,50	192176	33,26	12	
	6	814012	27,76	192177	28,41	12	
	10	814013	23,62	192178	24,18	12	
	16	814014	23,62	192179	24,18	12	
	20	814015	23,62	192180	24,18	12	
	25	814016	23,62	192181	24,18	12	
	32	814017	27,97	192182	28,63	12	
	40	814018	34,64	192183	35,46	12	
	50	814019	46,93	179624	48,04	12	
	63	814020	49,39	179626	50,55	12	
	2 Kutup	1	814086	86,12	192212	88,15	
2		814087	86,12	192213	88,15	6	
3		814088	86,12	192214	88,15	6	
4		814089	86,12	192215	88,15	6	
6		814090	76,54	192216	78,34	6	
10		814091	76,54	192217	78,34	6	
16		814092	76,54	192218	78,34	6	
20		814093	76,54	192219	78,34	6	
25		814094	76,54	192220	78,34	6	
32		814095	81,32	192221	83,24	6	
40		814096	86,12	192222	88,15	6	
50		814097	136,60	179666	139,80	6	
63		814098	150,00	179668	153,60	6	
3 Kutup		1	814164	120,20	192251	123,10	4
	2	814165	120,20	192252	123,10	4	
	3	814166	120,20	192253	123,10	4	
	4	814167	120,20	192254	123,10	4	
	6	814168	98,68	192255	101,10	4	
	10	814169	98,68	192256	101,10	4	
	16	814170	98,68	192257	101,10	4	
	20	814171	98,68	192258	101,10	4	
	25	814172	98,68	192259	101,10	4	
	32	814173	113,30	192260	115,90	4	
	40	814174	123,70	192261	126,60	4	
	50	814175	162,10	179708	165,90	4	
	63	814176	201,30	179710	206,10	4	
	4 Kutup	1	814242	178,90	192290	183,10	3
2		814243	178,90	192291	183,10	3	
3		814244	178,90	192292	183,10	3	
4		814245	178,90	192293	183,10	3	
6		814246	149,80	192294	153,40	3	
10		814247	143,10	192295	146,60	3	
16		814248	143,10	192296	146,60	3	
20		814249	143,10	192297	146,60	3	
25		814250	143,10	192298	146,60	3	
32		814251	154,30	192299	157,90	3	
40		814252	174,70	192300	178,80	3	
50		814253	248,50	179750	254,40	3	
63		814254	265,80	179752	272,60	3	

*NB7 grubunda 50A ve 63A ürünler NB1 serisi olarak sevk edilmektedir.



NB1 Serisi Otomatik Sigortalar

10 kA C | Yavaş Karakterli

	In (A) 230/400 V AC 50/60 Hz	Sipariş Kodu	Birim Fiyat (₺)	Kutu Adeti
1 Kutup 	1	179781	58,85	12
	2	179785	58,85	12
	3	179788	58,85	12
	4	179790	58,85	12
	6	179793	48,61	12
	10	179782	46,05	12
	16	179784	46,05	12
	20	179786	46,05	12
	25	179787	46,05	12
	32	179789	47,08	12
	40	179791	53,94	12
	50	179792	59,01	12
	63	179794	66,71	12
	2 Kutup 	1	179823	137,70
2		179827	137,70	6
3		179830	137,70	6
4		179832	137,70	6
6		179835	138,90	6
10		179824	119,70	6
16		179826	119,70	6
20		179828	119,70	6
25		179829	119,70	6
32		179831	138,90	6
40		179833	143,70	6
50		179834	162,70	6
63		179836	181,90	6
3 Kutup 		1	179865	204,60
	2	179869	204,60	4
	3	179872	204,60	4
	4	179874	204,60	4
	6	179877	160,70	4
	10	179866	149,30	4
	16	179868	149,30	4
	20	179870	149,30	4
	25	179871	158,40	4
	32	179873	165,00	4
	40	179875	175,60	4
	50	179876	192,20	4
	63	179878	227,40	4
	4 Kutup 	1	179907	268,50
2		179911	268,50	3
3		179914	268,50	3
4		179916	268,50	3
6		179919	217,00	3
10		179908	206,60	3
16		179910	206,60	3
20		179912	206,60	3
25		179913	206,60	3
32		179915	209,00	3
40		179917	221,70	3
50		179918	306,90	3
63		179920	344,40	3

DZ158 Serisi Otomatik Sigortalar

10 kA | Yavaş Karakterli

	In (A) 230/400 V AC 50/60 Hz	Sipariş Kodu	Birim Fiyat (₺)	Kutu Adeti
1 Kutup 	63	158088	130,80	12
	80	158089	136,40	12
	100	158087	151,80	12
	125	158107	244,20	12
3 Kutup 	63	158094	289,80	4
	80	158095	431,10	4
	100	158093	455,20	4
	125	158109	501,50	4
4 Kutup 	63	158097	578,10	3
	80	158098	591,60	3
	100	158096	611,50	3
	125	158110	838,00	3



NXB Serisi Aksesuarlar

	Ürün Tanımı	Sipariş Kodu	Birim Fiyat (₺)	Kutu Adeti
İlave Bloklar 	NXB AX-X1 Yardımcı kontak	814991	66,86	14
	NXB AL-X1 Alarm kontak	814990	66,86	14
	NXB SHT-X1 Açtırma bobini 24V/48V AC/DC	814988	97,50	9
	NXB SHT-X1 Açtırma bobini 230V/400V AC	814989	97,50	9
	NXB UVT Düşük gerilim bobini	814987	144,40	9

NB1 Serisi Aksesuarlar

	Ürün Tanımı	Sipariş Kodu	Birim Fiyat (₺)	Kutu Adeti
İlave Bloklar 	S9 açtırma Bobini 220/380 V	184986	150,90	9
	S9 açtırma Bobini 24 V AC/DC	184985	150,90	9
	S9 açtırma Bobini 48 V AC/DC	184984	150,90	9
	V9 Düşük gerilim Bobini 220/380 V	184988	223,40	9
	F9 Yardımcı Kontak Bloğu 3A 1NA+1NK	184994	112,30	14
	F9J Alarm Kontak 3A, 1NA+1NK	184996	112,30	14

DZ Serisi Aksesuarlar

	Ürün Tanımı 230/400 V AC 50/60 Hz	Sipariş Kodu	Birim Fiyat (₺)	Kutu Adeti
	AX-1 yardımcı Kontak Bloğu 3A, 1NA+1NK	158999	101,40	12



NL1 Serisi Kaçak Akım Röleleri

AC ve A Tipi | DIN Ray Tipi

AC Tipi (6kA)

Anlık ya da yavaşça artan AC kaçak akıma karşı gecikmesiz açma yapar.



	230/400 V AC 50/60 Hz	In (A)	Sipariş Kodu	Birim Fiyat (₺)
2 kutup	30mA	25 A	200212	168,50
		40 A	200213	169,10
		63 A	200214	193,20
		80 A	200277	262,10
		100A	200278	316,00
	300mA	25 A	200218	167,50
		40 A	200219	167,50
		63 A	200220	191,80
		80 A	200281	257,50
		100A	200282	289,10
4 kutup	30mA	25 A	200223	236,40
		40 A	200224	238,70
		63 A	200225	269,20
	300mA	25 A	200229	230,60
		40 A	200230	236,40
		63 A	200231	251,70
		80 A	200760	374,50
		100A	200758	421,30



A Tipi (10kA)

Anlık ya da yavaşça artan AC ve DC kaçak akımlarına karşı gecikmesiz açma yapar.



	230/400 V AC 50/60 Hz	In (A)	Sipariş Kodu	Birim Fiyat (₺)
2 kutup	30mA	25A	200584	252,20
		40A	200362	253,40
		63A	200363	267,90
4 kutup	30mA	25A	200368	323,40
		40A	200364	344,00
		63A	200365	394,00



AC-G Tipi (10kA)

Yavaşça artan AC kaçak akıma karşı, arıza noktasına en yakın konumdaki kaçak akım koruma rölesinin açmasını mümkün kılacak şekilde 10ms gecikmeli açma yapar.



	230/400 V AC 50/60 Hz	In (A)	Sipariş Kodu	Birim Fiyat (₺)
2 kutup	30mA	40A	200572	262,70
		63A	200575	270,70
	300mA	40A	200574	262,70
		63A	200577	262,70
4 kutup	30mA	40A	200578	466,40
		63A	200581	479,80
	300mA	40A	200580	359,20
		63A	200583	434,20



SI- A Tipi (6kA)

AC kaçak akım ve DC puls kaçak akımlara karşı koruma özelliği vardır. Harmonikler ve transiyent kaynaklı akım piklerinde açmaya karşı korumalıdır.





	230/400 V AC 50/60 Hz	In (A)	Sipariş Kodu	Birim Fiyat (₺)
2 kutup	30mA	25A	200629	299,40
		40A	200628	314,70
		63A	200627	401,60
	300mA	25A	200623	386,30
		40A	200622	414,50
		63A	200621	501,40
4 Kutup	30mA	25A	200638	414,50
		40A	200637	429,80
		63A	200636	544,90
	300mA	25A	200632	560,20
		40A	200631	560,20
		63A	200630	703,50



NB1L Kaçak Akım Korumalı Otomatik Sigortalar (6kA C)

Elektronik | DIN ray tipi

Kaçak akım korumalı otomatik sigortalar, kaçak akım rölesi ve termik manyetik devre kesiciden oluşan ürünlerdir.

	In (A)	Sipariş Kodu	Birim Fiyat (₺)
2 Kutup 30 mA 	6	197967	253,40
	10	197931	253,40
	16	197935	253,40
	20	197943	253,40
	25	197947	253,40
	32	197955	253,40
	40	197963	265,60
4 Kutup 300mA 	10	198105	506,20
	16	198109	506,20
	20	198117	506,20
	25	198121	506,20
	32	198129	521,70
	40	198137	578,50
	NB1L-40H Serisi 4 Kutup 40 A 10kA A Tipi Kaçak Akımlı DC Pulse Kesme		198315





NU6 Alçak Gerilim Parafudrları



NU6-IIIG/F Serisi Tip 1 ve Tip 2

Ürün Tanımı	Tip	Kutup Sayısı	Sürekli Çalışma Gerilimi Uc (V)	Imax (kA)	Up (kV)	Sipariş Kodu	Birim Fiyat (₺)
NU6-IIIG/F T2 20kA 320V 1P	Tip 2	1 Kutup	275	40	1,5	252499	189,50
NU6-IIIG/F T2 20kA 320V 1P+N	Tip 2	1 Kutup + Nötr	275	40	1,5	252515	406,80
NU6-IIIG/F T2 20kA 320V 3P	Tip 2	3 Kutup	275	40	1,5	252547	557,20
NU6-IIIG/F T2 20kA 320V 3P+N	Tip 2	3 Kutup + Nötr	275	40	1,5	252563	863,60
NU6-IIIG/F T1 100kA 385V 3P+N	Tip 1	3 Kutup + Nötr	385	100	2,5	252564	3.009,00

Noark - Alçak Gerilim Parafudrlar

Parafudr Tip 1 + 2

(Class I+II, T1+T2, B+C), I_{max} 50 kA (8/20 μ s)



	Ürün Tanımı	İşletme gerilimi	Sipariş Kodu	Birim Fiyat (₺)
1 Kutup	Ex9UE1+2 12.5 275	275V AC	103332	504,40
	Ex9UE1+2 12.5R 275	275V AC	103333	519,00
1 Kutup+Nötr	Ex9UE1+2 12.5 275	275V AC	103334	984,30
	Ex9UE1+2 12.5R 275	275V AC	103335	1.026,00
2 Kutup	Ex9UE1+2 12.5 275	275V AC	103336	1.026,00
	Ex9UE1+2 12.5R 275	275V AC	103337	1.080,00
3 Kutup	Ex9UE1+2 12.5 275	275V AC	103338	1.436,00
	Ex9UE1+2 12.5R 275	275V AC	103339	1.545,00
3 Kutup+Nötr	Ex9UE1+2 12.5 275	275V AC	103340	1.969,00
	Ex9UE1+2 12.5R 275	275V AC	103341	2.079,00
4 Kutup	Ex9UE1+2 12.5 275	275V AC	103342	2.079,00
	Ex9UE1+2 12.5R 275	275V AC	103343	2.256,00
Aksesuar	Ex9UE1+2 12.5 1P 275 M	275V AC	103330	358,20
	Ex9UE1+2 NPE M	N-PE	103331	358,20



Ex9UE C Sınıfı Alçak Gerilim Parafudr



Parafudr Tip 2 SPD
(Class II, T2, C), I_{max} 40 kA (8/20 μ s)

	Ürün Tanımı	İşletme Gerilimi	Sipariş Kodu	Birim Fiyat (₺)
1 Kutup	Ex9UE2 20 275	275V AC	103347	231,50
	Ex9UE2 20R 275	275V AC	103348	272,90
1 Kutup+Nötr	Ex9UE2 20 275	275V AC	103349	504,40
	Ex9UE2 20R 275	275V AC	103350	545,70
2 Kutup	Ex9UE2 20 275	275V AC	103351	504,40
	Ex9UE2 20R 275	275V AC	103352	545,70
3 Kutup	Ex9UE2 20 275	275V AC	103353	779,60
	Ex9UE2 20R 275	275V AC	103354	821,10
3 Kutup+Nötr	Ex9UE2 20 275	275V AC	103355	998,90
	Ex9UE2 20R 275	275V AC	103356	1.094,00
4 Kutup	Ex9UE2 20 275	275V AC	103357	1.080,00
	Ex9UE2 20R 275	275V AC	103358	1.189,00
1 Kutup	Ex9UE2 20 320	320 V AC	103754	280,20
	Ex9UE2 20R 320	320 V AC	103755	297,20
1 Kutup+Nötr	Ex9UE2 20 320	320 V AC	103756	582,30
	Ex9UE2 20R 320	320 V AC	103757	626,20
2 Kutup	Ex9UE2 20 320	320 V AC	103758	582,30
	Ex9UE2 20R 320	320 V AC	103759	626,20
3 Kutup	Ex9UE2 20 320	320 V AC	103760	869,80
	Ex9UE2 20R 320	320 V AC	103761	1.002,00
3 Kutup+Nötr	Ex9UE2 20 320	320 V AC	103762	1.189,00
	Ex9UE2 20R 320	320 V AC	103763	1.296,00
4 Kutup	Ex9UE2 20 20	320 V AC	103764	1.189,00
	Ex9UE2 20R 320	320 V AC	103765	1.296,00
1 Kutup	Ex9UE2 20 385	385 V AC	103766	333,80
	Ex9UE2 20R 385	385 V AC	103767	346,00
1 Kutup+Nötr	Ex9UE2 20 385	385 V AC	103768	706,50
	Ex9UE2 20R 385	385 V AC	103769	787,00
2 Kutup	Ex9UE2 20 385	385 V AC	103770	706,50
	Ex9UE2 20R 385	385 V AC	103771	787,00
3 Kutup	Ex9UE2 20 385	385 V AC	103772	1.029,00
	Ex9UE2 20R 385	385 V AC	103773	1.111,00
3 Kutup+Nötr	Ex9UE2 20 385	385 V AC	103774	1.296,00
	Ex9UE2 20R 385	385 V AC	103775	1.377,00
4 Kutup	Ex9UE2 20 385	385 V AC	103776	1.296,00
	Ex9UE2 20R 385	385 V AC	103777	1.377,00
1 Kutup	Ex9UE2 20 440	440 V AC	103359	333,80
	Ex9UE2 20R 440	440 V AC	103360	346,00
1 Kutup+Nötr	Ex9UE2 20 440	440 V AC	103361	706,50
	Ex9UE2 20R 440	440 V AC	103362	787,00
2 Kutup	Ex9UE2 20 440	440 V AC	103363	706,50
	Ex9UE2 20R 440	440 V AC	103364	787,00
3 Kutup	Ex9UE2 20 440	440 V AC	103365	1.029,00
	Ex9UE2 20R 440	440 V AC	103366	1.111,00
3 Kutup+Nötr	Ex9UE2 20 440	440 V AC	103367	1.296,00
	Ex9UE2 20R 440	440 V AC	103368	1.377,00
4 Kutup	Ex9UE2 20 440	440 V AC	103369	1.296,00
	Ex9UE2 20R 440	440 V AC	103370	1.377,00
Aksesuar	Ex9UE2 20 1P 275 M	275V AC	103344	333,80
	Ex9UE2 20 1P 320 M	320 V AC	103752	346,00
	Ex9UE2 20 1P 380 M	380 V AC	103753	706,50
	Ex9UE2 20 1P 440 M	440 V AC	103345	787,00
	Ex9UE2 40 NPE M	N-PE	103346	706,50



Fotovoltaik NB1 Serisi 63 DC Sigorta

6 kA C | DC Kesme

	In (A)	Sipariş Kodu	Birim Fiyat (₺)	Kutu Adeti
250 V 6KA DC 1 Kutup 	1	182699	104,00	12
	2	182700	104,00	12
	3	182701	104,00	12
	4	182702	104,00	12
	6	182703	93,06	12
	10	182704	87,58	12
	16	182706	87,58	12
	20	182707	87,58	12
	25	182708	87,58	12
	32	182709	93,06	12
	40	182710	104,00	12
	50	182711	109,50	12
	63	182712	115,00	12
	500 V 6KA DC 2 Kutup 	1	182713	212,00
2		182714	212,00	6
3		182715	212,00	6
4		182716	212,00	6
6		182717	197,40	6
10		182718	180,30	6
13		182719	180,30	6
16		182720	180,30	6
20		182721	180,30	6
25		182722	180,30	6
32		182723	197,40	6
40		182724	221,80	6
50		182725	231,50	6
63		182726	251,00	6
1000 V 6KA DC 4 Kutup 	1	182727	494,60	3
	2	182728	494,60	3
	3	182729	494,60	3
	4	182730	494,60	3
	6	182731	399,50	3
	10	182732	360,60	3
	13	182733	360,60	3
	16	182734	360,60	3
	20	182735	360,60	3
	25	182736	360,60	3
	32	182737	399,50	3
	40	182738	494,60	3
	50	182739	519,00	3
	63	182740	560,30	3



Fotovoltaik Sistem DC Devre Kesici

36 kA | 50 kA | DC Kesme

	Ürün Tanımı	In (A)	Termik Ayar Sahası	Sipariş Kodu	Birim Fiyat (₺)
3 Kutup	36kA Ex9MD1S TM	16	12.8-16A	101778	2.005,00
		20	16-20 A	101779	2.005,00
		25	20-25 A	101780	2.005,00
		32	25.6-32A	101781	2.005,00
		40	32-40A	101782	2.005,00
		50	40-50A	101783	2.005,00
		63	50.4-63A	101784	2.005,00
		80	64-80A	101785	2.005,00
		100	80-100A	101786	2.005,00
	125	100-125A	101787	2.005,00	
	Ex9MD2S TM	160	128-160A	101895	2.875,00
		180	144-180A	101896	2.943,00
		200	160-200A	101897	3.077,00
		225	180-225A	101898	3.212,00
		250	200-250A	101899	3.348,00
	50kA Ex9MD3N TM	315	252-315A	101969	4.015,00
		350	280-350A	101970	4.283,00
		400	320-400A	101971	4.551,00



	Ürün Tanımı	In (A)	Termik Ayar Sahası	Sipariş Kodu	Birim Fiyat (₺)
4 Kutup	36kA Ex9MD1S TM	16	12.8-16A	101838	2.541,00
		20	16-20 A	101839	2.541,00
		25	20-25 A	101840	2.541,00
		32	25.6-32A	101841	2.541,00
		40	32-40A	101842	2.541,00
		50	40-50A	101843	2.541,00
		63	50.4-63A	101844	2.541,00
		80	64-80A	101845	2.541,00
		100	80-100A	101846	2.541,00
	125	100-125A	101847	2.541,00	
	Ex9MD2S TM	160	128-160A	101931	3.747,00
		180	144-180A	101932	3.882,00
		200	160-200A	101933	4.015,00
		225	180-225A	101934	4.149,00
		250	200-250A	101935	4.283,00
	50kA Ex9MD3N TM	315	252-315A	101993	5.355,00
		350	280-350A	101994	5.621,00
		400	320-400A	101995	5.888,00



1000 V DC Kartuş Sigorta



Kutup	Ürün Tanımı	Tip	Sipariş Kodu	Birim Fiyat (₺)
1	Sigorta Tutucu	Ex9FP 30A	101766	58,83
2	Sigorta Tutucu	Ex9FP 30A	101767	115,00

NJMC1 Darbe Akım Anahtarı

Ürün Tanımı	In (A)	V (AC)	V (DC)	Sipariş Kodu	Birim Fiyat (₺)	Kutu Adeti
1 Kutup	16	220		657012	144,50	12
	16		24	657011	169,80	12
	32	220		657014	210,90	12
	32		24	657013	210,90	12



Standart	IEC/EN 61810-1
Bobin Besleme Gerilimi	AC:220V ; DC:24V
Kontak Akımı	16/32A
Kutup	1 Kutuplu
Başlangıç Kontak Direnci	100m Ohm
Maksimum Anahtarlama	4000VA 448W (16A) 8000VA 896 W (32 A)
Operasyon Süresi	≤20ms
Puls Gerilim Süresi	≥50ms
Kirlilik Seviyesi	I
Aşırı Gerilim Kategorisi	II
Sıcaklık Aralığı	-25...+550C

NCH8 Serisi Bina İçü Aydınlatma/Otomasyon Kontaktörü

DIN Ray Tipi

Sessiz Kontaktör AC- 1	In (A) 220/230 V AC 50/60 Hz	Yardımcı Kontak	Sipariş Kodu	Birim Fiyat (₺)	Kutu Adeti
2 Kutup	20 A	2NA	256054	120,50	8
	20 A	1NA +1NK	256052	120,50	8
	20 A	2NK	256053	120,50	8
	40 A	2NA	256081	313,60	6
	40 A	1NA +1NK	256083	313,60	6
	63 A	2NA	256093	392,30	6



Sessiz Kontaktör AC- 1	In (A) 220/230 V AC 50/60 Hz	Yardımcı Kontak	Sipariş Kodu	Birim Fiyat (₺)	Kutu Adeti
4 Kutup	20 A	4NA	256085	150,90	6
	20 A	2NA +2NK	256087	150,90	6
	25 A	4NA	256089	193,20	6
	25 A	2NA +2NK	256091	193,20	6
	40 A	4NA	256099	339,50	4
	63 A	4NA	256101	300,00	4
	63 A	3NA +1NK	256217	413,10	6
	63 A	2NA +2NK	256219	413,10	6



NTE8 Serisi LEDli Elektronik Zaman Rölesi

Elektronik | DIN Ray Tipi | 5A 1NA



Ürün Tanımı 230/400 V AC 50/60 Hz	Sipariş Kodu	Birim Fiyat (₺)	Kutu Adeti
0.1-10 sn	258326	214,40	8
12-120 sn	258347	214,40	8
36-360 sn	258361	214,40	8



NKG3 Dijital Zaman Saati

Zaman Saatleri



Ürün Tanımı 220 V AC 50/60 Hz	Sipariş Kodu	Birim Fiyat (₺)	Kutu Adeti
NKG3 8 ON veya 8 OFF Kontaklı	310024	426,20	1
Zaman Hassasiyeti	< 2 Saniye		
Zaman Rezervi	1 dakika-168 saat		
Mekanik Ömür	> 30.000		
Elektrik Ömür	>10.000		
Montaj Tipi	Raya Montaj		
Gösterge	Dijital Ekran		

KG316T Dijital Zaman Saati

Enerjisiz Yazlık, Ofis ve Sokak Aydınlatmalarına Özel



Ürün Tanımı 220 V AC 50/60 Hz	Sipariş Kodu	Birim Fiyat (₺)	Kutu Adeti
KG316T 8 ON veya 8 OFF Kontaklı	309009	525,30	1
Mekanik Ömür	1 X 10 5		
Elektrik Ömür	1 X 10 6		
Montaj Tipi	Raya Montaj		
Gösterge	Dijital Ekran		



NH4 Serisi Yük Ayırıcılar



	In (A) 230/400 V AC 50/60 Hz	Sipariş Kodu	Birim Fiyat (₺)
1 Kutup	32	398037	35,00
	63	398038	36,81
	100	398036	54,31
	125	398032	62,99
2 Kutup	32	398040	75,43
	63	398041	84,13
	100	398039	98,64
	125	398033	104,50
3 Kutup	32	398043	95,34
	63	398044	106,90
	100	398042	130,40
	125	398034	143,70
4 Kutup	32	398046	127,70
	63	398047	142,50
	100	398045	178,20
	125	398035	188,60



RT28N-32 Serisi Sigorta Yuvaları (gG/gL Hızlı Tip Sigorta)



	Ürün Tanımı 230/400 V AC 50/60 Hz	Sipariş Kodu	Birim Fiyat (₺)	Kutu Adeti
10 X 38 YUVALAR	1 Kutup	520484	22,58	12
	2 Kutup	520485	46,80	12
	3 Kutup	520486	66,11	12
gG/gL Silindirik Sigortalar 500 V AC	2A	520474	5,51	12
	4A	520475	5,51	12
	6A	520476	5,51	12
	10A	520478	5,51	10
	16A	520480	5,51	10
	20A	520481	5,51	10
	25A	520482	5,51	10
	32A	520483	5,72	10



NHR17 Serisi Yatay Yük Ayırıcıları

Yatay | AC Sınıfı



	Ürün Tanımı	Uygun Sigorta	Sipariş Kodu	Birim Fiyat (₺)
3 Kutup (Sigortasız)	100 A	Boy 00 Sigorta	403021	317,80
	160 A	Boy 00 ve Boy 0 Sigorta	403022	337,90
	250 A	80, 100, 125, 160, 200, 250	403023	797,20
	400 A	125, 160, 200, 250, 300, 315, 355, 400	403024	1.207,00
	630 A	315, 355, 400, 425, 500, 600	403025	1.582,00

NHRT40 Dikey Yük Ayırıcı

3 Faz



	Ürün Tanımı	Sipariş Kodu	Birim Fiyat (₺)
Birlikte Ayırma	NHRT41-160/3L	842051	965,70
	NHRT41-250/3L	842052	1.876,00
	NHRT41-400/3L	842053	2.198,00
	NHRT41-630/3L	842054	2.615,00
Bağımsız Ayırma	NHRT41-160/3	842047	965,70
	NHRT41-250/3	842048	1.876,00
	NHRT41-400/3	842049	2.198,00
	NHRT41-630/3	842050	2.615,00



NH40 Serisi Yük Ayırıcıları

Yatay | AC/DC Sınıfı

3150A'ye kadar sigortasız ayırıcı !



	Ürün Tanımı 400 V	Sipariş Kodu	Birim Fiyat (₺)
3 Kutup	125A	393261	818,60
	250A	393264	1.274,00
	400A	393266	1.975,00
	630A	393267	2.561,00
	1000 A	393268	4.225,00
	1250A	393269	4.252,00
	1600 A	393270	4.810,00
	2000 A	393271	12.068,00
	2500 A	393272	15.447,00
	3150 A	393273	15.689,00
	NH40 Serisi için Yardımcı Kontak 1NA+1 NK	NH40-AU	158,40
	NH40 Serisi Metal Çubuk+Pano üstü Kol 630 a kadar	NH40-EXH1	942,90
	NH40 Serisi Metal Çubuk+Pano üstü Kol 1000-3150 a kadar	NH40-EXH2	1.436,00



NXZ Serisi Otomatik Transfer Şalterleri

Ürün Tanımı	Nominal Akım In (A)	Kutup sayısı	Kısa Devre Kesme Kapasitesi Icu (kA)	Sipariş Kodu	Birim Fiyat (₺)
NXZM-63S/3B	10	3	25	256763	4.817,00
NXZM-63S/3B	16	3	25	256762	4.817,00
NXZM-63S/3B	25	3	25	256761	4.817,00
NXZM-63S/3B	32	3	25	256760	4.817,00
NXZM-63S/3B	40	3	25	256759	4.817,00
NXZM-63S/3B	50	3	25	256758	4.817,00
NXZM-63S/3B	63	3	25	256757	4.817,00
NXZM-125S/3B	80	3	25	256778	5.732,00
NXZM-125S/3B	100	3	25	256781	5.732,00
NXZM-125S/3B	125	3	25	256780	6.568,00
NXZM-160S/3B	160	3	35	256790	6.568,00
NXZM-250S/3B	180	3	35	256799	6.568,00
NXZM-250S/3B	200	3	35	256798	7.845,00
NXZM-250S/3B	225	3	35	256797	7.905,00
NXZM-250S/3B	250	3	35	256796	11.164,00
NXZM-400S/3B	315	3	50	256813	11.164,00
NXZM-400S/3B	350	3	50	256812	11.164,00
NXZM-400S/3B	400	3	50	256811	11.888,00
NXZM-630S/3B	500	3	50	256824	13.480,00
NXZM-630S/3B	630	3	50	256823	13.480,00
NXZM-800S/3B	700	3	50	256833	15.322,00
NXZM-800S/3B	800	3	50	256832	15.879,00
NXZM-63S/4B	10	4	25	256777	5.063,00
NXZM-63S/4B	16	4	25	256776	5.063,00
NXZM-63S/4B	25	4	25	256775	5.063,00
NXZM-63S/4B	32	4	25	256774	5.063,00
NXZM-63S/4B	40	4	25	256773	5.063,00
NXZM-63S/4B	50	4	25	256772	5.063,00
NXZM-63S/4B	63	4	25	256771	5.063,00
NXZM-125S/4B	80	4	25	256786	6.156,00
NXZM-125S/4B	100	4	25	256789	6.157,00
NXZM-125S/4B	125	4	25	256788	7.525,00
NXZM-160S/4B	160	4	35	256794	7.525,00
NXZM-250S/4B	180	4	35	256809	7.525,00
NXZM-250S/4B	200	4	35	256808	7.525,00
NXZM-250S/4B	225	4	35	256807	7.525,00
NXZM-250S/4B	250	4	35	256806	14.096,00
NXZM-400S/4B	315	4	50	256821	14.096,00
NXZM-400S/4B	350	4	50	256820	14.096,00
NXZM-400S/4B	400	4	50	256819	14.096,00
NXZM-630S/4B	500	4	50	256830	15.206,00
NXZM-630S/4B	630	4	50	256829	15.206,00
NXZM-800S/4B	700	4	50	256839	16.715,00
NXZM-800S/4B	800	4	50	256838	17.272,00



Kompakt Tip Devre Kesiciler

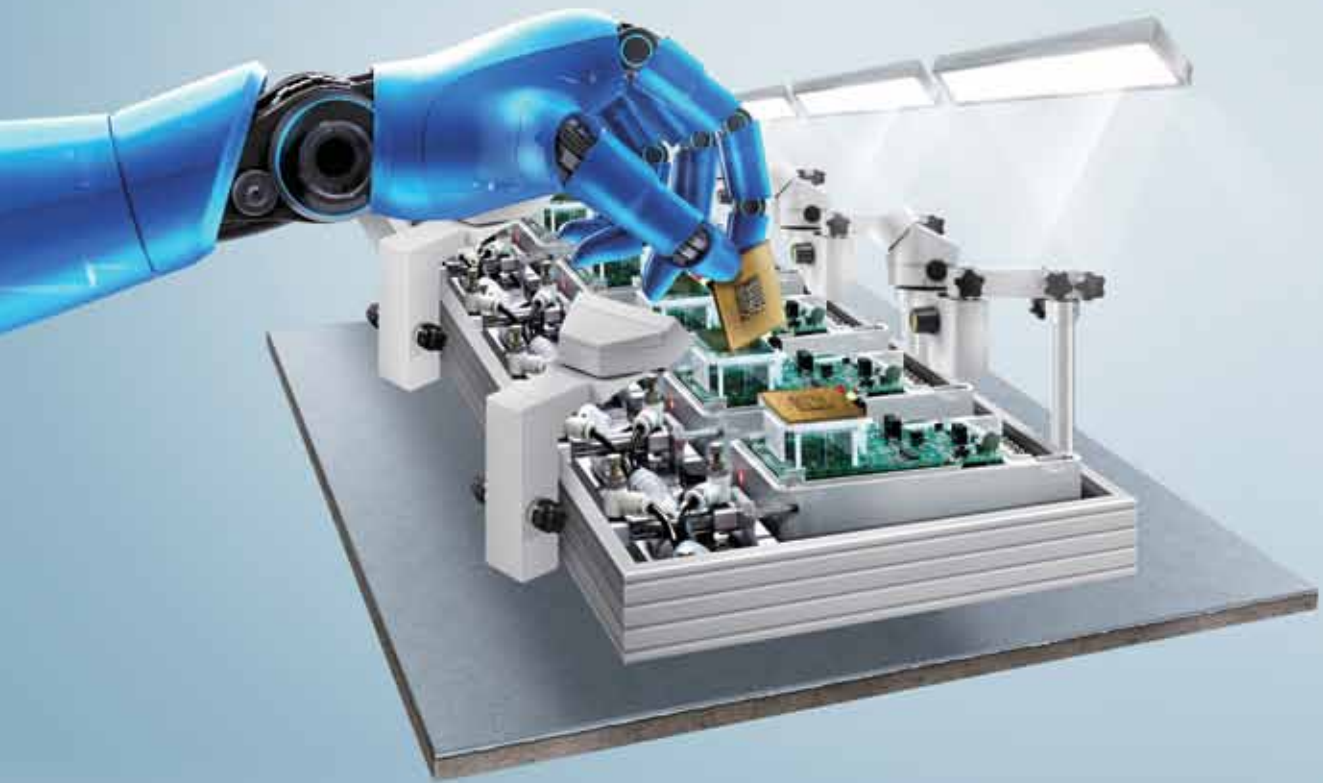

CHINT
CHINT ELECTRIC



NXM Serisi Devre Kesiciler

Sabit | Termik Manyetik | 3 Kutuplu

Nominal Akım In (A)	Ürün Tanımı	Kesme Kapasitesi Icu(kA)	Sipariş Kodu	Birim Fiyat (₺)	Ürün Tanımı	Kesme Kapasitesi Icu(kA)	Sipariş Kodu	Birim Fiyat (₺)
10	G NXM-63S/3300	25	205882	454,40	G NXM-63H/3300	50	205890	486,10
16	G NXM-63S/3300	25	205883	454,40	G NXM-63H/3300	50	205891	486,10
20	G NXM-63S/3300	25	205884	454,40	G NXM-63H/3300	50	205892	486,10
25	G NXM-63S/3300	25	205885	454,40	G NXM-63H/3300	50	205893	486,10
32	G NXM-63S/3300	25	205886	454,40	G NXM-63H/3300	50	205894	486,10
40	G NXM-63S/3300	25	205887	454,40	G NXM-63H/3300	50	205895	486,10
50	G NXM-63S/3300	25	205888	454,40	G NXM-63H/3300	50	205896	486,10
63	G NXM-63S/3300	25	205889	454,40	G NXM-63H/3300	50	205897	486,10
80	G NXM-125S/3300	25	131361	529,20	G NXM-125H/3300	50	844290	566,30
100	G NXM-125S/3300	25	131362	546,20	G NXM-125H/3300	50	844283	584,40
125	G NXM-125S/3300	25	131363	580,00	G NXM-125H/3300	50	844284	620,60
160	G NXM-160S/3300	36	131364	709,20	G NXM-160H/3300	50	844323	758,80
200	G NXM-250S/3300	36	131367	875,90	G NXM-250H/3300	50	844331	937,20
225	G NXM-250S/3300	36	131368	947,20	G NXM-250H/3300	50	844332	1.014,00
250	G NXM-250S/3300	36	131369	966,60	G NXM-250H/3300	50	844333	1.035,00
315	G NXM-400S/3300	36	131371	2.004,00	G NXM-400H/3300	50	844355	2.143,00
400	G NXM-400S/3300	36	131373	2.219,00	G NXM-400H/3300	50	844358	2.374,00
500	G NXM-630S/3300	50	131374	2.738,00	G NXM-630H/3300	70	844369	2.930,00
630	G NXM-630S/3300	50	131375	2.859,00	G NXM-630H/3300	70	844370	3.059,00
800	G NXM-800S/3300	50	131376	6.686,00	G NXM-800H/3300	70	844379	7.154,00
1000	G NXM-1000S/3300	50	131377	7.801,00	G NXM-1000H/3300	70	844276	8.347,00
1250	G NXM-1250S/3300T	50	218740	10.808,00	G NXM-1250H/3300T	70	218742	11.565,00
1600	G NXM-1600S/3300T	50	131378	12.815,00	G NXM-1600H/3300T	70	844313	13.712,00



Sabit | Termik Manyetik | 4 Kutuplu

Nominal Akım In (A)	Ürün Tanımı	Kesme Kapasitesi Icu(kA)	Sipariş Kodu	Birim Fiyat (₺)	Ürün Tanımı	Kesme Kapasitesi Icu(kA)	Sipariş Kodu	Birim Fiyat (₺)
10	G NXM-63S/4300B	25	205906	735,50	G NXM-63H/4300B	50	205898	787,00
16	G NXM-63S/4300B	25	205907	735,50	G NXM-63H/4300B	50	205899	787,00
20	G NXM-63S/4300B	25	205908	735,50	G NXM-63H/4300B	50	205900	787,00
25	G NXM-63S/4300B	25	205909	735,50	G NXM-63H/4300B	50	205901	787,00
32	G NXM-63S/4300B	25	205910	735,50	G NXM-63H/4300B	50	205902	787,00
40	G NXM-63S/4300B	25	205911	735,50	G NXM-63H/4300B	50	205903	787,00
50	G NXM-63S/4300B	25	205912	735,50	G NXM-63H/4300B	50	205904	787,00
63	G NXM-63S/4300B	25	205913	735,50	G NXM-63H/4300B	50	205905	787,00
80	G NXM-125S/4300B	25	844310	796,10	G NXM-125H/4300B	50	844298	851,90
100	G NXM-125S/4300B	25	844303	825,20	G NXM-125H/4300B	50	844291	882,90
125	G NXM-125S/4300B	25	844304	859,40	G NXM-125H/4300B	50	844292	919,60
160	G NXM-160S/4300B	20	844328	992,90	G NXM-160H/4300B	50	844325	1.063,00
180	G NXM-250S/4300B	36	844340	1.081,00	G NXM-250H/4300B	50	844335	1.157,00
200	G NXM-250S/4300B	36	844341	1.120,00	G NXM-250H/4300B	50	844336	1.199,00
225	G NXM-250S/4300B	36	844342	1.199,00	G NXM-250H/4300B	50	844337	1.284,00
250	G NXM-250S/4300B	36	844343	1.269,00	G NXM-250H/4300B	50	844338	1.358,00
315	G NXM-400S/4300B	36	844364	2.926,00	G NXM-400H/4300B	50	844359	3.131,00
350	G NXM-400S/4300B	36	844366	2.887,00	G NXM-400H/4300B	50	844361	3.089,00
400	G NXM-400S/4300B	36	844367	3.160,00	G NXM-400H/4300B	50	844362	3.380,00
500	G NXM-630S/4300B	50	844376	4.736,00	G NXM-630H/4300B	70	844372	5.068,00
630	G NXM-630S/4300B	50	844377	5.077,00	G NXM-630H/4300B	70	844373	5.433,00
800	G NXM-800S/4300B	50	844384	6.965,00	G NXM-800H/4300B	70	844381	7.453,00
1000	G NXM-1000S/4300B	50	844281	8.079,00	G NXM-1000H/4300B	70	844278	8.645,00
1250	G NXM-1600S/4300TB	50	844320	15.322,00	G NXM-1600H/4300TB	70	844315	16.395,00
1600	G NXM-1600S/4300TB	50	844321	16.436,00	G NXM-1600H/4300TB	70	844316	17.587,00



NXM Serisi Devre Kesiciler

Aksesuarlar

	Ürün Tanımı	Besleme Gerilimi	Sipariş Kodu	Birim Fiyat (₺)
	NXM-63/125 Sağ		946951	136,00
	NXM-160 Sol		946946	136,00
	NXM-160 Sağ		946949	136,00
	NXM-250/320 Sol		946944	153,80
	NXM-250/320 Sağ		946943	153,80
	NXM- 400/630 Sol		946941	364,40
	NXM- 800 Sol		946938	414,60
	NXM- 800 Sağ		946935	414,60
	NXM- 1600 Sol		146145	501,50
	NXM-63/125 Sol	AC 230V	203834	396,70
	NXM-160 Sol	AC 230V	152863	396,70
	NXM-250/320 Sağ	AC 230V	152865	424,60
	NXM- 400/630 Sağ	AC 230V	946968	780,10
	NXM- 800 Sol	AC 230V	946978	882,60
	NXM- 1000 Sol	AC 230V	946985	965,00
	NXM- 1600 Sol	AC 230V	946960	1.951,00
	NXM-63/125 Sol	AC 230V	946996	309,80
	NXM-63/125 Sağ	AC 230V	946958	309,80
	NXM-160 Sol	AC 230V	946953	309,80
	NXM-160 Sağ	AC 230V	946974	309,80
	NXM-250/320 Sol	AC 230V	946972	382,30
	NXM-250/320 Sağ	AC 230V	946969	382,30
	NXM- 400/630 Sağ	AC 230V	946966	709,90
	NXM- 800 Sağ	AC 230V	946981	823,50
	NXM- 1000 Sağ	AC 230V	946988	878,10
	NXM- 1600 Sol	AC 230V	946961	1.059,00
	NXM-63/125 Sağ		201842	99,17
	NXM-160 Sol		946947	99,17
	NXM-160 Sağ		946950	99,17
	NXM-250/320 Sol		203836	99,17
	NXM- 400/630 Sol		946939	222,90
	NXM- 800 Sol		946937	234,10
	NXM- 800 Sağ		946934	234,10
	NXM- 1600 Sağ		146146	234,10
	NXM-63/125	AC/DC 230V	946922	2.630,00
	NXM-160S	AC/DC 230V	946905	2.630,00
	NXM-160H	AC/DC 230V	946904	2.630,00
	NXM-250/320	AC/DC 230V	946926	2.786,00
	NXM- 400/630	AC/DC 230V	946912	5.015,00
	NXM- 800	AC/DC 230V	946908	5.572,00
	NXM- 1000	AC/DC 230V	946916	6.686,00
	NXM- 1600	AC/DC 230V	946914	7.243,00
	NXM-63/125		946896	406,80
	NXM-160		946886	406,80
	NXM-250/320		946889	406,80
	NXM- 400/630		946891	501,50
	NXM- 800		946887	557,20
	NXM- 1000		946894	612,90
	NXM- 1600		946892	780,10

* Kutup belirtilmeyen ürünler 3 ve 4 kutup için uygundur.

* Kesme kapasitesi modeli belirtilmeyen ürünler S ve H modelleri için uygundur.

NM8 Alçak Gerilim Devre Kesiciler

Ayarlı | Termik Manyetik | 3 Kutuplu



Ürün Tanımı	Kısa Devre Kesme Kapasitesi Icu (kA)	Kesme Ics (kA)	Termik Ayar Sahası (A)	Manyetik Ayar Sahası (A)	Sipariş Kodu	Birim Fiyat (₺)
NM8-125S 3 Kutup 16A T.M.Ş.	50	50	14-16	80-160	149678	754,80
NM8-125S 3 Kutup 20A T.M.Ş.	50	50	16-20	100-200	149679	754,80
NM8-125S 3 Kutup 25A T.M.Ş.	50	50	20-25	125-250	149680	752,20
NM8-125S 3 Kutup 32A T.M.Ş.	50	50	25-32	160-320	149681	752,20
NM8-125S 3 Kutup 40A T.M.Ş.	50	50	32-40	200-400	149682	752,20
NM8-125S 3 Kutup 50A T.M.Ş.	50	50	40-50	250-500	149683	752,20
NM8-125S 3 Kutup 63A T.M.Ş.	50	50	50-63	320-630	149684	752,20
NM8-125S 3 Kutup 80A T.M.Ş.	50	50	64-80	400-800	149685	752,20
NM8-125S 3 Kutup 100A T.M.Ş.	50	50	80-100	500-1000	149358	768,50
NM8-125S 3 Kutup 125A T.M.Ş.	50	50	100-125	620-1250	149676	917,20
NM8-250S 3 Kutup 160A T.M.Ş.	50	50	128-160	800-1600	149477	941,30
NM8-250S 3 Kutup 200A T.M.Ş.	50	50	160-200	1000-2000	149478	1.183,00
NM8-250S 3 Kutup 250A T.M.Ş.	50	50	200-250	1250-2500	149479	1.207,00
NM8-400S 3 Kutup 315A T.M.Ş.	70	70	252-315	1565-3150	149725	2.939,00
NM8-400S 3 Kutup 400A T.M.Ş.	70	70	320-400	2000-4000	149726	3.319,00
NM8-630S 3 Kutup 500A T.M.Ş.	70	70	400-500	2500-5000	149486	3.987,00
NM8S-630S 3 Kutup 630A T.M.Ş.	70	70	252-630	945-7560	149490	5.069,00
NM8-800S 3 Kutup 800A T.M.Ş.	50	25	640-800	4000-8000	149916	7.643,00
NM8-1250S 3 Kutup 1000A T.M.Ş.	50	25	800-1000	5000-10000	149858	10.689,00
NM8-1250S 3 Kutup 1250A T.M.Ş.	50	25	1000-1250	6250-12500	149856	13.216,00
NM8S-1600S 3kutup 1600A Elk. Açt. Ünt. T.M.Ş.	50	25	640-1600	2400-19200	150495	18.939,00



Ayarlı | Termik Manyetik | 4 Kutuplu



Ürün Tanımı	Kısa Devre Kesme Kapasitesi Icu (kA)	Kesme Ics (kA)	Termik Ayar Sahası (A)	Manyetik Ayar Sahası (A)	Sipariş Kodu	Birim Fiyat (₺)
NM8-125S 4 Kutup 32A T.M.Ş.	50	50	25-32	160-320	149934	1.216,00
NM8-125S 4 Kutup 40A T.M.Ş.	50	50	32-40	200-400	149935	1.216,00
NM8-125S 4 Kutup 50A T.M.Ş.	50	50	40-50	250-500	149936	1.216,00
NM8-125S 4 Kutup 63A T.M.Ş.	50	50	50-63	315-630	149937	1.216,00
NM8-125S 4 Kutup 80A T.M.Ş.	50	50	64-80	400-800	149938	1.328,00
NM8-125S 4 Kutup 100A T.M.Ş.	50	50	80-100	500-1000	149939	1.328,00
NM8-125S 4 Kutup 125A T.M.Ş.	50	50	100-125	625-1250	149940	1.507,00
NM8-250S 4 Kutup 160A T.M.Ş.	50	50	128-160	800-1600	149942	1.867,00
NM8-250S 4 Kutup 200A T.M.Ş.	50	50	160-200	1000-2000	149943	2.066,00
NM8-250S 4 Kutup 250A T.M.Ş.	50	50	200-250	1250-2500	149944	2.210,00
NM8-400S 4 Kutup 315A T.M.Ş.	70	70	252-315	1575-3150	149960	4.526,00
NM8-400S 4 Kutup 400A T.M.Ş.	70	70	320-400	2000-4000	149962	4.819,00
NM8-630S 4 Kutup 500A T.M.Ş.	70	70	400-500	2500-5000	149964	5.276,00
NM8-800S 4 Kutup 630A T.M.Ş.	50	50	504-630	3780-7560	149994	10.111,00
NM8-800S 4 Kutup 800A T.M.Ş.	50	50	640-800	4000-8000	149995	12.793,00
NM8-1250S 4 Kutup 1000A T.M.Ş.	50	50	800-1000	5000-10000	149996	19.334,00
NM8-1250S 4 Kutup 1250A T.M.Ş.	50	50	800 - 1250	6125-12500	150000	19.934,00



NM8 Serisi Alçak Gerilim Devre Kesiciler

Ayarlı | Termik Manyetik Yüksek Kesme Kapasitesi 100kA | 3 Kutup



Ürün Tanımı	Kısa Devre Kesme Kapasitesi		Termik Ayar Sahası (A)	Manyetik Ayar Sahası (A)	Sipariş Kodu	Birim Fiyat (₺)
	Icu (kA)	Ics (kA)				
NM8-125H 3 Kutup 40A	100	100	32-40	200-400	149690	1.069,00
NM8-125H 3 Kutup 50A	100	100	40-50	250-500	149691	1.069,00
NM8-125H 3 Kutup 63A	100	100	50-63	320-630	149692	1.069,00
NM8-125H 3 Kutup 80A	100	100	64-80	400-800	149693	1.069,00
NM8-125H 3 Kutup 100A	100	100	80-100	500-1000	149694	1.069,00
NM8-125H 3 Kutup 125A	100	100	100-125	620-1250	149695	1.147,00
NM8-250H 3 Kutup 160A	100	100	128-160	800-1600	149470	1.472,00
NM8-250H 3 Kutup 200A	100	100	160-200	1000-2000	149471	1.992,00
NM8-250H 3 Kutup 250A	100	100	200-250	1250-2500	149472	2.086,00











Sadece Manyetik Korumalı Devre Kesiciler | 3 Kutup



Ürün Tanımı	Kısa Devre Kesme Kapasitesi		Manyetik Ayar Sahası (A)	Sipariş Kodu	Birim Fiyat (₺)
	Icu (kA)	Ics (kA)			
NM8-125S 3 kutup 32A 50kA	50	50	160-320	149410	1.147,00
NM8-125S 3 kutup 40A 50kA	50	50	200-400	149407	1.147,00
NM8-125S 3 kutup 50A 50kA	50	50	250-500	149409	1.147,00
NM8-125S 3 kutup 80A 50kA	50	50	400-800	149406	1.147,00
NM8-125S 3 kutup 100A 50kA	50	50	500-1000	149405	1.147,00
NM8-125S 3 kutup 125A 50kA	50	50	525-1250	149404	1.750,00
NM8-250S 3 kutup 160A 50kA	50	50	800-1600	149416	1.750,00
NM8-250S 3 kutup 200A 50kA	50	50	1000-2000	149415	1.750,00
NM8-250S 3 kutup 250A 50kA	50	50	1250-2500	149414	1.750,00

NM8 Serisi Kompakt Tip Devre Kesiciler

Aksesuarlar

	Ürün Tanımı	Besleme Gerilimi	Sipariş Kodu	Birim Fiyat (₺)
Mekanik Kilit 	NM8-125 3P		150790	253,40
	NM8-125 4P		150792	253,40
	NM8-250 3P ve NM8S-125, 250 3P		150794	253,40
	NM8-250 4P ve NM8S-125, 250 4P		150795	253,40
	NM8 / NM8S-400, 630 3P		150796	428,50
	NM8 / NM8S-400, 630 4P		150797	428,50
Sabit Tip Şalteri Soketli Tipe Dönüştürme Aksesuarları - Soket Sabit Parça 	NM8-250 3P ve NM8S-125, 250 3P		150760	1.501,00
	NM8-125 3P		150761	1.282,00
	NM8-125 4P		150875	1.282,00
	NM8-250 4P ve NM8S-125, 250 4P		150876	2.210,00
	NM8 / NM8S-400, 630 4P		150878	5.336,00
	NM8 / NM8S-400, 630 3P		150892	4.426,00
Din Rayı Bağlantı Aparatı 	NM8-125 3P		150763	65,17
	NM8-250 3P ve NM8S-125, 250 3P		150765	72,41
	NM8-250 4P ve NM8S-125, 250 4P		150766	75,30
	NM8-125 4P		150767	79,65
Açtırma Bobini 	NM8-125	220V AC	150848	440,50
	NM8S-125, 250, 400, 630 ve NM8-250, 400, 630	220V AC	150747	452,60
	NM8 / NM8S-800, 1250	220V AC	150851	1.038,00
	NM8-125	380V AC	150849	452,60
	NM8S-125, 250, 400, 630 ve NM8-250, 400, 630	380V AC	150746	452,60
	NM8 / NM8S-800, 1250	380V AC	150853	1.038,00
	NM8-125	24V DC	150847	779,60
	NM8S-125, 250, 400, 630 ve NM8-250,400,630	24V DC	150748	794,20
	NM8 / NM8S-800, 1250, 1600	24V DC	150753	1.241,00
Düşük Gerilim Bobini 	NM8-125	220V AC	150850	482,80
	NM8S-125, 250, 400, 630 ve NM8-250, 400, 630	220V AC	150750	482,80
	NM8 / NM8S-800, 1250	220V AC	150855	862,40
	NM8-125	380V AC	150846	494,80
	NM8S-125, 250, 400, 630 ve NM8-250, 400, 630	380V AC	150749	494,80
	NM8 / NM8S-800, 1250	380V AC	150856	724,10
	NM8S-125, 250, 400, 630 ve NM8-250, 400, 630	24V DC	900330	723,60
	NM8 / NM8S-800, 1250	24V DC	900333	862,40
Alarm/ Yardımcı Kontak 	Yardımcı kontak - Tüm NM8 serileri		150869	148,40
	Alarm kontak - NM8 / NM8S-800, 1250 hariç tüm seriler		150870	174,00
	Alarm kontak - NM8 / NM8S-800, 1250		900309	253,40
Motor 	NM8-125	220V AC/DC	150881	2.469,00
	NM8S-125,250 - NM8-250	220V AC/DC	150882	2.469,00
	NM8 / NM8S-400, 630	220V AC/DC	150884	5.675,00
	NM8 / NM8S-800, 1250, 1600	220V AC/DC	150890	5.851,00
Direkt Döner Kurma Kolu 	NM8-125		150902	271,60
	NM8-250		150903	271,60
	NM8-400, 630		150900	410,30
	NM8S-125, 250		150758	271,60
	NM8S-400, 630		150898	325,90
Milli Uzatılmış Döner Kurma Kolu Mekanizması 	NM8-125		150905	543,20
	NM8-250		150896	543,20
	NM8-400, 630		150909	573,20
	NM8S-125, 250		150759	392,30
	NM8S-400,630		150907	519,00
Ekonomik Seri, Milli Uzatılmış Döner Kurma Kolu Mekanizması 	NM8-125 3P		150773	380,10
	NM8S-125, 250 3P ve NM8-250 3P		150775	380,10
	NM8 / NM8S-400, 630 3P/4P		150777	506,90
	NM8 / NM8S-800, 1250 3P/4P		150910	1.026,00
	NM8S-125 4P		150912	440,50
	NM8S-125, 250 4P ve NM8-250 4P		150913	440,50
Kilitleme Aksesuarı 	NM8-125 Asma Kilit		150839	76,64
	NM8S-125, 250 - NM8-250 Asma Kilit		150840	82,12
	NM8 / NM8S-400, 630 Asma Kilit		150842	82,12
	NM8 / NM8S-1250 Asma Kilit		150844	87,58

*Kutup sayısı belirtilmeyen aksesuarlar; ilgili ürünün tüm kutupları için kullanılmaktadır.



Kaçak Akım Algılamalı (Yangın Koruma) Kompakt Tip Devre Kesiciler

4 Kutup | Dahili Açtırma Bobinli



Ürün Tanımı	Kesme Kap. Icu (kA)	Kaçak Akım Ayar Sahası (mA)	Gecikme Süresi (s)	Sipariş Kodu	Birim Fiyat (₺)
NXMLE-125H/4310 Y D 25A	36	200-300-500	0.3-0.4-0.5	948589	1.216,00
NXMLE-125H/4310 Y D 32A	36	200-300-500	0.3-0.4-0.5	948590	1.223,00
NXMLE-125H/4310 Y D 40A	36	200-300-500	0.3-0.4-0.5	948591	1.270,00
NXMLE-125H/4310 Y D 50A	36	200-300-500	0.3-0.4-0.5	948592	1.276,00
NXMLE-125H/4310 Y D 63A	36	200-300-500	0.3-0.4-0.5	948593	1.284,00
NXMLE-125H/4310 Y D 80A	36	200-300-500	0.3-0.4-0.5	948594	1.291,00
NXMLE-125H/4310 Y D 100A	36	200-300-500	0.3-0.4-0.5	948587	1.298,00
NXMLE-125H/4310 Y D 125A	36	200-300-500	0.3-0.4-0.5	948588	1.469,00
NXMLE-160S/4310 Y D 160A	35	200-300-500	0.3-0.4-0.5	948619	1.554,00
NXMLE-250S/4310 Y D 180A	35	200-300-500	0.3-0.4-0.5	948637	1.722,00
NXMLE-250S/4310 Y D 200A	35	200-300-500	0.3-0.4-0.5	948638	1.925,00
NXMLE-250S/4310 Y D 225A	35	200-300-500	0.3-0.4-0.5	948639	1.993,00
NXMLE-250S/4310 Y D 250A	35	200-300-500	0.3-0.4-0.5	948640	2.026,00
NXMLE-400S/4310 Y D 315A	50	200-300-500	0.3-0.4-0.5	948662	3.714,00
NXMLE-400S/4310 Y D 350A	50	200-300-500	0.3-0.4-0.5	948663	3.884,00
NXMLE-400S/4310 Y D 400A	50	200-300-500	0.3-0.4-0.5	948664	3.917,00
NXMLE-630S/4310 Y D 500A	50	200-300-500	0.3-0.4-0.5	948675	5.234,00
NXMLE-630S/4310 Y D 630A	50	200-300-500	0.3-0.4-0.5	948676	5.285,00

*Gecikmesiz tip ve farklı kaçak akım ayar sahalı ürünler için sorunuz.

NM8L Kaçak Korumalı 4 Kutuplu Kompakt Şalter

Kaçak Akım Korumalı Şalter



	Termik Manyetik Açtırma Ünitesi 50 – 500mA	Kesme Kapasitesi Icu (kA)	Termik I (A)	Sipariş Kodu	Birim Fiyat (₺)
NM8L -125S	25/4	50	20-25	169231	2.764,00
	32/4	50	26-32	169232	2.764,00
	40/4	50	33-40	169233	2.764,00
	50/4	50	40-50	169234	2.764,00
	63/4	50	51-63	169235	2.764,00
	80/4	50	64-80	169243	2.764,00
	100/4	50	81-100	169244	2.764,00
	125/4	50	101-125	150041	2.764,00
NM8L -250S	160/4	50	126-160	169299	3.478,00
	200/4	50	161-200	169300	3.687,00
	250/4	50	201-250	169301	3.759,00

Açık Tip Devre Kesiciler



NAI-X Serisi (LSI Koruma)

Ayarlı | Elektronik

3 Kutup Sabit Tip

Ürün Tanımı	Kesme Kap. Icu (kA)	Ics (kA)	Termik Ayar Sahası Ir(A)	Sipariş Kodu	Birim Fiyat (₺)
3 Kutup Sabit Tip NAI-2000XH 630A, 65kA	65	65	0,4-1*In	937394	14.482,00
3 Kutup Sabit Tip NAI-2000XH 800A, 65kA	65	65	0,4-1*In	937414	15.086,00
3 Kutup Sabit Tip NAI-2000XH 1000A, 65kA	65	65	0,4-1*In	937314	15.447,00
3 Kutup Sabit Tip NAI-2000XH 1250A, 65kA	65	65	0,4-1*In	937334	16.767,00
3 Kutup Sabit Tip NAI-2000XH 1600A, 65kA	65	65	0,4-1*In	937354	18.437,00
3 Kutup Sabit Tip NAI-2000XH 2000A, 65kA	65	65	0,4-1*In	937374	21.723,00
3 Kutup Sabit Tip NAI-3200XN 2500A, 65kA	65	65	0,4-1*In	937558	27.757,00
3 Kutup Sabit Tip NAI-3200XN 3200A, 65kA	65	65	0,4-1*In	937579	32.584,00
3 Kutup Sabit Tip NAI-4000X 4000A, 80kA	80	65	0,4-1*In	101164	54.306,00

*3 Kutup Sabit Tip 4000A ürünün Icu/Ics=%100 seçeneği için sorunuz.

4 Kutup Sabit Tip

Ürün Tanımı	Kesme Kap. Icu (kA)	Ics (kA)	Termik Ayar Sahası Ir(A)	Sipariş Kodu	Birim Fiyat (₺)
4 Kutup Sabit Tip NAI-2000XH 1000A, 65kA	65	65	0,4-1*In	937324	22.929,00
4 Kutup Sabit Tip NAI-2000XH 1250A, 65kA	65	65	0,4-1*In	937344	24.136,00
4 Kutup Sabit Tip NAI-2000XH 1600A, 65kA	65	65	0,4-1*In	937364	25.947,00
4 Kutup Sabit Tip NAI-2000XH 2000A, 65kA	65	65	0,4-1*In	937384	27.154,00
4 Kutup Sabit Tip NAI-3200XH 2500A, 65kA	65	65	0,4-1*In	937566	34.997,00
4 Kutup Sabit Tip NAI-3200XN 3200A, 65kA	65	65	0,4-1*In	937587	41.031,00

4 Kutup Çekmeceli Tip

Ürün Tanımı	Kesme Kap. Icu (kA)	Ics (kA)	Termik Ayar Sahası Ir(A)	Sipariş Kodu	Birim Fiyat (₺)
4 Kutup Çekmeceli Tip NAI-6300XN - 4000A, 100kA	100	100	0,4-1*In	937595	67.581,00

3 Kutup Çekmeceli Tip

Ürün Tanımı	Kesme Kap. Icu (kA)	Ics (kA)	Termik Ayar Sahası Ir(A)	Sipariş Kodu	Birim Fiyat (₺)
3 Kutup Çekmeceli NA 1-2000XH 630A, 65kA	65	65	0,4-1*In	937392	18.102,00
3 Kutup Çekmeceli NA 1-2000XH 800A, 65kA	65	65	0,4-1*In	937412	18.102,00
3 Kutup Çekmeceli NA 1-2000XH 1000A, 65kA	65	65	0,4-1*In	937312	18.404,00
3 Kutup Çekmeceli NA 1-2000XH 1250A, 65kA	65	65	0,4-1*In	937332	18.851,00
3 Kutup Çekmeceli NA 1-2000XH 1600A, 65kA	65	65	0,4-1*In	937352	22.065,00
3 Kutup Çekmeceli NA 1-2000XH 2000A, 65kA	65	65	0,4-1*In	937372	26.392,00
3 Kutup Çekmeceli NA 1-3200XN 2500A, 65kA	65	65	0,4-1*In	937556	33.794,00
3 Kutup Çekmeceli NA 1-3200XN 3200A, 65kA	65	65	0,4-1*In	937577	38.402,00
3 Kutup Çekmeceli NA 1-6300XN 4000A, 100kA	100	100	0,4-1*In	937591	54.306,00
3 Kutup Çekmeceli NA 1-6300XN 5000A, 100kA	100	100	0,4-1*In	937599	108.611,00

Aksesuarlar

Ürün Tanımı	Tipi	Sipariş Kodu	Birim Fiyat (₺)
Motor mekanizması 630A-2000A	220 V AC	102944	2.692,00
Motor 2500-5000 A	220 V AC	102950	3.001,00
Açtırma Bobini 630A-3200A NA-1	220 V AC	102840	844,20
Kapama Bobini 630A-3200A NA-1	220 V AC	102833	844,20
Düşük Gerilim Bobini NA-1	220 V AC	102851	844,20
Düşük Gerilim Bobini autonom tip		102848	875,00
Gecikmeli Düşük Gerilim Bobini AC220V NA-1	1-7 Saniye	102857	1.087,00
NA1 asma kilit, tek kilitli	1 Kilit 1 Anahtar	102804	362,10
NA1 asma kilit, üç kilitli	3 Kilit 2 Anahtar	102806	362,10
NA1-2000-6300 kablo tipi mekanik kilit	Kablo	102789	4.481,00
NA1-2000~6300 sabitleme plakası		102894	16,71



Mekanik kilit seçimi için mutlaka okuyunuz:

* Çekmeceli tip için sadece 1 adet 102789 sipariş edilmelidir. * Sabit tip için 1 adet 102789 ve 2 adet 102894 sipariş edilmelidir.

NA8G Serisi

Ayarlı | ZSI Özelliği



	Ürün Tanımı 400/690 V AC	Kesme Kap. Icu (kA)	Termik I (A)	Sipariş Kodu	Birim Fiyat (₺)
Elektronik Kontrol Üniteli Sabit Tip 3 Kutuplu	NA8G-1600 1000 A	50	400-1000	111414	20.516,00
	NA8G-1600 1250 A	50	500-1250	111418	20.818,00
	NA8G-1600 1600 A	50	640-1600	111415	21.406,00
	NA8G-3200 2000 A	50	800-2000	111417	30.790,00
	NA8G-3200 2500 A	50	1000-2500	111421	33.188,00
	NA8G-3200 3200 A	50	1280-3200	111422	33.870,00



NA8G-Özellikler

- Arıza halinde sistemi zararlı etkilerden koruma
- Arıza anında yükü olabildiğince kısa sürede arıza akımına maruz bırakmak.
- Gereksiz triple açmaların önüne geçerek işletme güvenliğini sağlamak.
- Akıllı şebeke uygulamalarında.
- Alçak gerilim dağıtım panosunun akıllı şebekeye bağlantısı.
- Haberleşme yetenekleri sayesinde uzaktan erişim ve sistemin bakımını olanak sağlar.
- Bölgesel Seçicilik Kaskad Bağlantı (ZSI)
- Küçük ebatları sayesinde panoda minimum yer kaplar

Toroid Röle ve Akım Trafosu



	Ürün Tanımı 230/400 V AC	Sipariş Kodu	Birim Fiyat (₺)
Toroid Röle	RDC -01 serisi 0.03-0.5A 1NA/1NK	900001	1.029,00
	RDC -02 serisi 0.025-25A 1NA/1NK	900002	1.762,00
Panoya Montaj Toroid Röle	RDC-11 serisi 0.025-2.5A 1NA/1NK	900004	1.903,00
Toroid	Akım trafosu TTC serisi toroid 60mm	900104	647,50
	Akım trafosu TTC serisi toroid 110mm	900101	1.240,00
	Akım trafosu TTC serisi toroid 160mm	900102	2.959,00
	Akım trafosu TTC serisi toroid 210mm	900103	3.312,00



Akım Trafoları



Ürün Tanımı	Primer Akımı	Sekonder Akımı	Anma Gücü (VA)	Sınıf (Class)	Bara Durumu	Sipariş Kodu	Birim Fiyat (₺)
CT-10 20/5 10VA Cl:0,5 A.G. Akım Trafosu	20	5	10	0.5	Baralı	500101	151,60
CT-10 30/5 10VA Cl:0,5 A.G. Akım Trafosu	30	5	10	0.5	Baralı	500102	151,60
CT-10 40/5 10VA Cl:0,5 A.G. Akım Trafosu	40	5	10	0.5	Baralı	500103	151,60
CT-10 50/5 10VA Cl:0,5 A.G. Akım Trafosu	50	5	10	0.5	Baralı	500104	151,60
CT-10 60/5 10VA Cl:0,5 A.G. Akım Trafosu	60	5	10	0.5	Baralı	500105	151,60
CT-10 75/5 10VA Cl:0,5 A.G. Akım Trafosu	75	5	10	0.5	Baralı	500106	151,60
CT-10 100/5 10VA Cl:0,5 A.G. Akım Trafosu	100	5	10	0.5	Baralı	500107	151,60
CT-10 125/5 10VA Cl:0,5 A.G. Akım Trafosu	125	5	10	0.5	Baralı	500108	151,60
CT-10 150/5 10VA Cl:0,5 A.G. Akım Trafosu	150	5	10	0.5	Baralı	500109	151,60
CT-30 200/5 10VA Cl:0,5 A.G. Akım Trafosu Kalın	200	5	10	0.5	Barasız	500110	115,40
CT-30 250/5 10VA Cl:0,5 A.G. Akım Trafosu	250	5	10	0.5	Barasız	500111	112,00
CT-40 300/5 10VA Cl:0,5 A.G. Akım Trafosu	300	5	10	0.5	Barasız	500112	113,70
CT-40 400/5 10VA Cl:0,5 A.G. Akım Trafosu	400	5	10	0.5	Barasız	500113	113,70
CT-40 500/5 10VA Cl:0,5 A.G. Akım Trafosu	500	5	10	0.5	Barasız	500114	113,70
CT-40 600/5 10VA Cl:0,5 A.G. Akım Trafosu	600	5	10	0.5	Barasız	500115	113,70
CT-60 750/5 10VA Cl:0,5 A.G. Akım Trafosu	750	5	10	0.5	Barasız	500116	151,60
CT-60 800/5 15VA Cl:0,5 A.G. Akım Trafosu	800	5	15	0.5	Barasız	500117	172,20
CT-60 1000/5 15VA Cl:0,5 A.G. Akım Trafosu	1000	5	15	0.5	Barasız	500118	196,40
CT-60 1200/5 15VA Cl:0,5 A.G. Akım Trafosu	1200	5	15	0.5	Barasız	500119	196,40
CT-60 1250/5 15VA Cl:0,5 A.G. Akım Trafosu	1250	5	15	0.5	Barasız	500120	196,40
CT-80 1500/5 15VA Cl:0,5 A.G. Akım Trafosu	1500	5	15	0.5	Barasız	500121	251,40
CT-100 2000/5 15VA Cl:0,5 A.G. Akım Trafosu	2000	5	15	0.5	Barasız	500122	279,10
CT-100 2500/5 15VA Cl:0,5 A.G. Akım Trafosu	2500	5	15	0.5	Barasız	500124	292,90
CT-100 3000/5 15VA Cl:0,5 A.G. Akım Trafosu	3000	5	15	0.5	Barasız	500126	344,50
CT-100 3200/5 15VA Cl:0,5 A.G. Akım Trafosu	3200	5	15	0.5	Barasız	500128	361,80
CT-100 4000/5 30VA Cl:0,5 A.G. Akım Trafosu	4000	5	30	0.5	Barasız	500130	378,90
CT-100 5000/5 30VA Cl:0,5 A.G. Akım Trafosu	5000	5	30	0.5	Barasız	500131	465,00

* Mühürlü akım trafoları için sorunuz.



AG Kuru Tip Kondansatörler

Monofaze Güç Kondansatörleri

Anma Gerilimi (V)	Anma Gücü (kVAr)	Ürün Tanımı	Sipariş Kodu	Birim Fiyat (₺)
230	0.25	NWC6-230V 0.25kvar 1P	799011	128,40
230	0.5	NWC6-230V 0.5kvar 1P	799012	131,80
230	1	NWC6-230V 1kvar 1P	799013	148,60
230	1.5	NWC6-230V 1.5kvar 1P	799014	182,30
230	2.5	NWC6-230V 2.5kvar 1P	799015	229,70
230	5	NWC6-230V 5kvar 1P	799016	439,00
230	7.5	NWC6-230V 7.5kvar 1P	799017	776,70
230	10	NWC6-230V 10kvar 1P	799018	979,30

Trifaze Güç Kondansatörleri

400	0.5	NWC6-400V 0.5kvar 3P	799019	172,20
400	1	NWC6-400V 1kvar 3P	799020	179,00
400	1.5	NWC6-400V 1.5kvar 3P	799021	206,00
400	2.5	NWC6-400V 2.5kvar 3P	799022	229,70
400	5	NWC6-400V 5kvar 3P	799023	236,40
400	7.5	NWC6-400V 7.5kvar 3P	799024	297,20
400	10	NWC6-400V 10kvar 3P	799025	359,60
400	15	NWC6-400V 15kvar 3P	799026	486,30
400	20	NWC6-400V 20kvar 3P	799029	621,40
400	25	NWC6-400V 25kvar 3P	799030	754,80
400	30	NWC6-400V 30kvar 3P	799031	827,30
450	5	NWC6-450V 5kvar 3P	799032	263,50
450	7.5	NWC6-450V 7.5kvar 3P	799033	314,10
450	10	NWC6-450V 10kvar 3P	799034	371,40
450	15	NWC6-450V 15kvar 3P	799035	469,40
450	20	NWC6-450V 20kvar 3P	799036	655,10
450	25	NWC6-450V 25kvar 3P	799037	692,30
450	30	NWC6-450V 30kvar 3P	799038	793,50
525	7.5	NWC6-525V 7.5kvar 3P	799040	381,60
525	10	NWC6-525V 10kvar 3P	799041	415,30
525	15	NWC6-525V 15kvar 3P	799042	523,40
525	20	NWC6-525V 20kvar 3P	799043	726,00
525	25	NWC6-525V 25kvar 3P	799044	928,60
525	30	NWC6-525V 30kvar 3P	799045	979,30





Şönt Reaktörler - Endüktif Yük Reaktörleri

Monofaze Şönt Reaktörler

Anma Gerilimi (V)	Anma Gücü (kVAr)	Ürün Tanımı	Sipariş Kodu	Birim Fiyat (₺)
230	0.25	Shnt-230V 0.25kvar 1P	500001	464,40
230	0.3	Shnt-230V 0.3kvar 1P	500002	482,90
230	0.5	Shnt-230V 0.5kvar 1P	500003	538,60
230	1	Shnt-230V 1kvar 1P	500004	743,00
230	1.5	Shnt-230V 1.5kvar 1P	500005	947,20
230	2.5	Shnt-230V 2.5kvar 1P	500006	1.561,00
230	3.5	Shnt-230V 3.5kvar 1P	500007	2.229,00
230	5	Shnt-230V 5kvar 1P	500008	2.972,00
230	7	Shnt-230V 7kvar 1P	500009	3.436,00
230	7.5	Shnt-230V 7.5kvar 1P	500010	3.714,00
230	10	Shnt-230V 10kvar 1P	500011	4.829,00

Trifaze Şönt Reaktörler

Anma Gerilimi (V)	Anma Gücü (kVAr)	Ürün Tanımı	Sipariş Kodu	Birim Fiyat (₺)
400	0.5	Shnt-400V 0.5kvar 3P	500012	1.319,00
400	1	Shnt-400V 1kvar 3P	500013	1.486,00
400	1.5	Shnt-400V 1.5kvar 3P	500014	1.672,00
400	2	Shnt-400V 2kvar 3P	500015	2.154,00
400	2.5	Shnt-400V 2.5kvar 3P	500016	2.229,00
400	3	Shnt-400V 3kvar 3P	500017	2.600,00
400	5	Shnt-400V 5kvar 3P	500018	3.547,00
400	7.5	Shnt-400V 7.5kvar 3P	500019	4.272,00
400	10	Shnt-400V 10kvar 3P	500020	5.201,00
400	12.5	Shnt-400V 12.5kvar 3P	500021	5.943,00
400	15	Shnt-400V 15.0kvar	500022	6.686,00
400	20	Shnt-400V 20kvar 3P	500023	9.658,00
400	25	Shnt-400V 25kvar 3P	500024	11.143,00
400	30	Shnt-400V 30kvar 3P	500025	11.887,00
400	40	Shnt-400V 40kvar 3P	500026	14.857,00
400	50	Shnt-400V 50kvar 3P	500027	19.687,00

Endüktif Yük Sürücü- SVC Yük Sürücü

Anma Gerilimi (V)	Anma Gücü (kVAr)	Bağlanabilen Şönt Reaktör	Ürün Tanımı	Sipariş Kodu	Birim Fiyat (₺)
400	5	3 x 1.5kvar	5kvar SVC yük sürücü (3 x 1.5kvar)	500028	2.043,00
400	10	3 x 3.5kvar	10kvar SVC yük sürücü (3 x 3.5kvar)	500029	2.508,00
400	20	3 x 7kvar	20kvar SVC yük sürücü (3 x 7kvar)	500030	3.343,00
400	30	3 x 10kvar	30kvar SVC yük sürücü (3 x 10kvar)	500031	3.714,00

CJ19 Serisi Kompanzasyon Kontaktörleri

3 Kutup Sabit Tip



Ürün Tanımı	Yardımcı Kontakt	Sipariş Kodu	Birim Fiyat (₺)
CJ19 serisi 3 kutup 7,5 kVAR	1NA+1NK	253731	253,60
CJ19 serisi 3 kutup 12kVAR	1NA+1NK	243764	325,10
CJ19 serisi 3 kutup 18kVAR	1NA+1NK	243881	414,90
CJ19 serisi 3 kutup 20kVAR	1NA+1NK	243998	418,40
CJ19 serisi 3 kutup 25 kVAR	1NA+2NK	253732	572,90
CJ19 serisi 3 kutup 30kVAR	1NA+2NK	244079	712,20
CJ19 serisi 3 kutup 40kVAR	1NA+2NK	253734	954,80
CJ19 serisi 3 kutup 50kVAR	1NA+2NK	244160	1.136,00



Harmonik Filtre Reaktörleri

Anma Gerilimi (V)	Anma Gücü (kVAR)	Rezonans Frekansı (Hz)	%p	Ürün Tanımı	Sipariş Kodu	Birim Fiyat (₺)
400	0.83	189	%7	CHNTHFR-%7-189Hz 400V 0.83kvar	500032	687,20
400	1.5	189	%7	CHNTHFR-%7-189Hz 400V 1.5kvar	500033	835,80
400	2.5	189	%7	CHNTHFR-%7-189Hz 400V 2.5kvar	500034	872,90
400	5	189	%7	CHNTHFR-%7-189Hz 400V 5.0kvar	500035	1.022,00
400	6.25	189	%7	CHNTHFR-%7-189Hz 400V 6.25kvar	500036	1.115,00
400	10	189	%7	CHNTHFR-%7-189Hz 400V 10.0kvar	500037	1.301,00
400	12.5	189	%7	CHNTHFR-%7-189Hz 400V 12.5kvar	500038	1.486,00
400	15	189	%7	CHNTHFR-%7-189Hz 400V 15.0kvar	500039	1.486,00
400	20	189	%7	CHNTHFR-%7-189Hz 400V 20.0kvar	500040	1.820,00
400	25	189	%7	CHNTHFR-%7-189Hz 400V 25.0kvar	500041	2.043,00
400	30	189	%7	CHNTHFR-%7-189Hz 400V 30.0kvar	500042	2.285,00
400	40	189	%7	CHNTHFR-%7-189Hz 400V 40.0kvar	500043	2.415,00
400	50	189	%7	CHNTHFR-%7-189Hz 400V 50.0kvar	500044	2.600,00
400	75	189	%7	CHNTHFR-%7-189Hz 400V 75.0kvar	500046	4.644,00

Not: %p, %5,67 ve %14 değerli ürünler için sorunuz.

Motor Koruma ve Kontrol Ürünleri



CHINT
CHINT ELECTRIC

NC1 Serisi Kontaktörler

3 Kutup 220 VA AC



Ürün Tanımı	Anma Gücü P(kW)400V	Anma Akımı I(A) (AC3)	Termik Akım Ith(AC1)	Yardımcı Kontakt	Sipariş Kodu	Birim Fiyat (₺)
NCI-0901M	4	9	20	1NK	220796	96,28
NCI-0910M	4	9	20	1NA	221029	96,28
NCI-1201M	5,5	12	20	1NK	221124	101,10
NCI-1210M	5,5	12	20	1NA	221355	101,10
NCI-1801M	7,5	18	32	1NK	221446	116,80
NCI-1810M	7,5	18	32	1NA	221541	116,80
NCI-2501M	11	25	40	1NK	221630	156,50
NCI-2510M	11	25	40	1NA	221861	156,50
NCI-3201M	15	32	50	1NK	221953	240,70
NCI-3210M	15	32	50	1NA	222048	240,70
NCI-4011M	18,5	40	60	1NA+1NK	222268	391,20
NCI-5011M	22	50	80	1NA+1NK	222489	469,40
NCI-6511M	30	65	80	1NA+1NK	222710	578,90
NCI-8011M	37	80	95	1NA+1NK	222931	746,20
NCI-9511M	45	95	95	1NA+1NK	223152	828,00

NXC Serisi Kontaktörler

3 Kutup 220V AC 1NA+1NK



Ürün Tanımı	Anma Gücü P(kW)400V	Anma Akımı I(A) (AC3)	Termik Akım Ith(AC1)	Yardımcı Kontakt	Sipariş Kodu	Birim Fiyat (₺)
NXC-09 220V 50/60Hz(R)	4	9	20	1NA+1NK	925353	98,68
NXC-12 220V 50/60Hz(R)	5.5	12	25	1NA+1NK	925479	103,50
NXC-18 220V 50/60Hz(R)	7.5	18	32	1NA+1NK	925607	120,70
NXC-25 220V 50/60Hz(R)	11	25	40	1NA+1NK	925735	165,40

Daha büyük güçler için sorunuz.

NC1 Serisi Kontaktörler

4 Kutup 220 VA AC



Ürün Tanımı	Anma Gücü P(kW)400V	Anma Akımı I(A) (AC3)	Termik Akım Ith(AC1)	Sipariş Kodu	Birim Fiyat (₺)
NCI-0904M	4	9	20	220890	114,70
NCI-1204M	5,5	12	20	221216	131,50
NCI-2504M	11	25	40	221722	199,20
NCI-4004M	18,5	40	60	222139	525,00
NCI-5004M	22	50	80	222360	598,90
NCI-6504M	30	65	80	222581	701,10
NCI-8004M	37	80	95	222802	934,10
NCI-9504M	45	95	95	223023	983,30

NC1 Serisi Kontaktörler

3 Kutup 24 VDC



Ürün Tanımı	Anma Gücü P(kW)400V	Anma Akımı I(A) (AC3)	Termik Akım Ith(AC1)	Yardımcı Kontakt	Sipariş Kodu	Birim Fiyat (₺)
NC1-0901Z	4	9	20	1NK	220881	197,70
NC1-0910Z	4	9	20	1NA	221112	197,70
NC1-1201Z	5,5	12	20	1NK	221207	215,40
NC1-1210Z	5,5	12	20	1NA	221437	215,40
NC1-1801Z	7,5	18	32	1NK	221529	226,80
NC1-1810Z	7,5	18	32	1NA	221621	226,80
NC1-2501Z	11	25	40	1NK	221713	319,40
NC1-2510Z	11	25	40	1NA	221944	319,40
NC1-3201Z	15	32	50	1NK	222036	428,40
NC1-3210Z	15	32	50	1NA	222130	428,40
NC1-4011Z	18,5	40	60	1NA + 1NK	222351	769,30
NC1-5011Z	22	50	80	1NA + 1NK	222572	826,20
NC1-6511Z	30	65	80	1NA + 1NK	222793	964,40
NC1-8011Z	37	80	95	1NA + 1NK	223014	1.177,00
NC1-9511Z	45	95	95	1NA + 1NK	223235	1.315,00

3 Kutup 24 VAC



Ürün Tanımı	Anma Gücü P(kW)400V	Anma Akımı I(A) (AC3)	Termik Akım Ith(AC1)	Yardımcı Kontakt	Sipariş Kodu	Birim Fiyat (₺)
NC1-0901 24V 50/60Hz	4	9	20	1NK	220805	96,54
NC1-0910 24V 50/60Hz	4	9	20	1NA	221038	96,54
NC1-1201 24V 50/60Hz	5,5	12	20	1NK	221133	101,40
NC1-1210 24V 50/60Hz	5,5	12	20	1NA	221363	101,40
NC1-1801 24V 50/60Hz	7,5	18	32	1NK	221455	117,20
NC1-1810 24V 50/60Hz	7,5	18	32	1NA	221550	117,20
NC1-2501 24V 50/60Hz	11	25	40	1NK	221639	156,90
NC1-2510 24V 50/60Hz	11	25	40	1NA	221870	156,90
NC1-3201 24V 50/60Hz	15	32	50	1NK	221962	241,40
NC1-3210 24V 50/60Hz	15	32	50	1NA	222056	241,40
NC1-4011 24V 50/60Hz	18,5	40	60	1NA + 1NK	222277	392,30
NC1-5011 24V 50/60Hz	22	50	80	1NA + 1NK	222495	470,70
NC1-6511 24V 50/60Hz	30	65	80	1NA + 1NK	222719	580,50
NC1-8011 24V 50/60Hz	37	80	95	1NA + 1NK	222940	748,30
NC1-9511 24V 50/60Hz	45	95	95	1NA + 1NK	223161	830,30

NC1 Serisi Kontaktörler

3 Kutup 110 VAC



Ürün Tanımı	Anma Gücü P(kW)400V	Anma Akımı I(A) (AC3)	Termik Akım Ith(AC1)	Yardımcı Kontakt	Sipariş Kodu	Birim Fiyat (₺)
NC1-0901 110V 50/60Hz	4	9	20	1NK	220787	96,54
NC1-0910 110V 50/60Hz	4	9	20	1NA	221020	96,54
NC1-1201 110V 50/60Hz	5.5	12	20	1NK	221115	101,40
NC1-1210 110V 50/60Hz	5.5	12	20	1NA	221346	101,40
NC1-1801 110V 50/60Hz	7.5	18	32	1NK	221440	117,20
NC1-1810 110V 50/60Hz	7.5	18	32	1NA	221532	117,20
NC1-2501 110V 50/60Hz	11	25	40	1NK	221624	156,90
NC1-2510 110V 50/60Hz	11	25	40	1NA	221852	156,90
NC1-3201 110V 50/60Hz	15	32	50	1NK	221947	241,40
NC1-3210 110V 50/60Hz	15	32	50	1NA	222039	241,40
NC1-4011 110V 50/60Hz	18.5	40	60	1NA + 1NK	222259	392,30
NC1-5011 110V 50/60Hz	22	50	80	1NA + 1NK	222480	470,70
NC1-6511 110V 50/60Hz	30	65	80	1NA + 1NK	222701	580,50
NC1-8011 110V 50/60Hz	37	80	95	1NA + 1NK	222922	748,30
NC1-9511 110V 50/60Hz	45	95	95	1NA + 1NK	223143	830,30



NC1 Serisi Yardımcı Aksesuarlar



Açıklama	Termik Akım Ith (A) AC1	Yardımcı Kontakt	Sipariş Kodu	Birim Fiyat (₺)	Kutu Adeti	
Yardımcı Kontakt Bloğu	F4-22	10	2NA+2NK	257019	42,73	10
	F4-02	10	2NK	257020	26,05	10
	F4-04	10	4NK	257021	42,73	10
	F4-11	10	1NA+1NK	257022	26,05	10
	F4-13	10	1NA+3NK	257023	42,73	10
	F4-20	10	2NA	257024	26,05	10
	F4-31	10	3NA+1NK	257025	42,73	10
	F4-40	10	4NA	257026	42,73	10
Yardımcı Kontakt Yana Takılan Tip	NCF1-11C	10	1NA+1NK	223238	56,16	10

Açıklama	Sipariş Kodu	Birim Fiyat (₺)	
Mekanik Kilit	NC1-09-32 & NXC-09-38 Mekanik kilit	256717	58,50
	NC1-40-65 & NXC-40-65 Mekanik kilit	777989	69,61
	NC1-80-95 & NC1-4004-6504 & NXC-75-100 Mekanik kilit	777988	81,90



NC2 Serisi Kontaktörler

AC-1 AC-3 AC-4 Sınıfı



	Ürün Adı	Anma Gücü P(kW), 400 V AC	Anma Akımı I (A), AC3	Termik Akım Ith (A) AC1	Sipariş Kodu	Birim Fiyat (₺)
3 Kutuplu 220 V AC	NC2-115M	55	115	200	671433	1.449,00
	NC2-150M	75	150	200	671398	1.584,00
	NC2-185M	90	185	275	671435	2.064,00
	NC2-225M	110	225	275	671400	2.482,00
	NC2-265M	132	265	315	236732	2.897,00
	NC2-330M	160	330	380	236055	4.103,00
	NC2-400M	200	400	450	236154	4.116,00
	NC2-500M	250	500	630	236254	6.819,00
4 Kutuplu 220 V AC	NC2-115M4	55	115	200	671434	1.992,00
	NC2-150M4	75	150	200	671399	2.177,00
	NC2-185M4	90	185	275	671436	2.806,00
	NC2-225M4	110	225	275	671401	2.897,00
	NC2-265M4	132	265	315	671403	4.238,00
	NC2-330M4	160	330	380	236103	5.552,00
	NC2-400M4	200	400	450	236203	5.890,00
	NC2-630M4	335	600	800	236352	10.132,00



NC2 Serisi Kontaktör Aksesuarları



	Ürün Adı	Yardımcı Kontakt	Sipariş Kodu	Birim Fiyat (₺)	Kutu Adeti
Yardımcı Kontakt Bloğu	NCF4-20	2NA	257024	26,06	10
	NCF4-02	2NK	257020	26,06	10
	NCF4-11	1NA+1NK	257022	26,06	10
	NCF4-40	4NA	257026	42,73	10
	NCF4-04	4NK	257021	42,73	10
	NCF4-22	2NA+2NK	257019	42,73	10
	NCF4-13	1NA+3 NK	257023	42,73	10
	NCF4-31	3NA+1 NK	257025	42,73	10



		Ayar Sahası	Geciktirme	Sipariş Kodu	Birim Fiyat (₺)	
Zaman Rölesi	NCF5-T0	0,1s-3s	Çekme	1NA+1NK	258021	253,40
	NCF5-T2	0,1s-30s	Çekme	1NA+1NK	258022	253,40
	NCF5-T4	10s-180s	Çekme	1NA+1NK	258023	253,40
	NCF5-D0	0,1s-3s	Düşme	1NA+1NK	258018	253,40
	NCF5-D2	0,1s-30s	Düşme	1NA+1NK	258019	253,40
	NCF5-D4	10s-180s	Düşme	1NA+1NK	258020	253,40



	Ürün Adı	Uyumlu Kontaktörler	Sipariş Kodu	Birim Fiyat (₺)
Yatay Mekanik Kilit	NC2-H01	NC2-115/150	237995	125,50
	NC2-H02	NC2-185/225	237997	195,70
	NC2-H03	NC2 265/330/400/500	237999	223,40
	NC2-H04	NC2-630	237993	366,40



	Ürün Adı	Sipariş Kodu	Birim Fiyat (₺)
Bobinler	NC2-115/150 220V AC	671926	301,80
	NC2-185/225 220V AC	671924	361,40
	NC2-265/330 220V AC	671992	549,20
	NC2-400 220V AC	671998	737,90
	NC2-500 220V AC	671997	757,60
	NC2-630 220V AC	671996	943,10



Termik Röleler

NC1 Kontaktör Serisine Uyumlu Termik Röleler | 1NA+1NK



Termikler	Uyumlu Kontaktörler	Termik Ayar Sahası	Sipariş Kodu	Birim Fiyat (₺)
NR2-25/0.16	NC1-09...32	0,1-0,16 A	268132	141,70
NR2-25/0.25	NC1-09...32	0,16-0,25 A	268133	141,70
NR2-25/0.4	NC1-09...32	0,25-0,40 A	268134	141,70
NR2-25/0.63	NC1-09...32	0.40-0,63 A	268135	141,70
NR2-25/1	NC1-09...32	0,63-1 A	268136	141,70
NR2-25/1.6	NC1-09...32	1-1.6 A	268137	141,70
NR2-25/2	NC1-09...32	1,25-2 A	268138	141,70
NR2-25/2.5	NC1-09...32	1.6-2,5 A	268131	141,70
NR2-25/4	NC1-09...32	2,5-4 A	268139	141,70
NR2-25/6	NC1-09...32	4-6 A	268140	141,70
NR2-25/8	NC1-09...32	5,5-8A	268141	141,70
NR2-25/10	NC1-09...32	7-10 A	268096	141,70
NR2-25/13	NC1-09...32	9-13 A	268095	141,70
NR2-25/18	NC1-09...32	12-18 A	268097	141,70
NR2-25/25	NC1-09...32	17-25 A	268142	141,70
NR2-36/32	NC1-32	23-32 A	268143	187,00
NR2-36/36	NC1-32	28-36 A	268144	194,60
NR2-93/32	NC1-40...95	23-32 A	268145	258,60
NR2-93/40	NC1-40...95	30-40 A	268146	263,90
NR2-93/50	NC1-40...95	37-50 A	268147	269,20
NR2-93/65	NC1-40...95	48-65 A	268148	274,50
NR2-93/70	NC1-40...95	55-70 A	268149	442,40
NR2-93/80	NC1-40...95	63-80 A	268150	461,00
NR2-93/93	NC1-40...95	80-93 A	268151	562,30



NXC Kontaktör Serisine Uyumlu Termik Röleler



Termikler	Termik Ayar Sahası	Sipariş Kodu	Birim Fiyat (₺)
NXR-25 0.1-0.16A(R)	0,1-0,16 A	837105	107,70
NXR-25 0.16-0.25A(R)	0,16-0,25 A	837106	107,70
NXR-25 0.25-0.4A(R)	0,25-0,40 A	837107	107,70
NXR-25 0.4-0.63A(R)	0.40-0,63 A	837108	107,70
NXR-25 0.63-1A(R)	0,63-1 A	837109	107,70
NXR-25 1-1.6A(R)	1-1.6 A	837110	107,70
NXR-25 1.25-2A(R)	1,25-2 A	837111	107,70
NXR-25 1.6-2.5A(R)	1.6-2,5 A	837112	107,70
NXR-25 2.5-4A(R)	2,5-4 A	837113	107,70
NXR-25 4-6A(R)	4-6 A	837114	107,70
NXR-25 5.5-8A(R)	5,5-8A	837115	107,70
NXR-25 7-10A(R)	7-10 A	837116	107,70
NXR-25 9-13A(R)	9-13 A	837117	107,70
NXR-25 12-18A(R)	12-18 A	837118	107,70
NXR-25 17-25A(R)	17-25 A	837119	107,70

Daha büyük akım değerleri için sorunuz.

Mini Kontaktörler

AC-1 AC-3 AC-4 Sınıfı



Ürün Tanımı	Anma Gücü P(kW). 400 V AC	Anma Akımı I (A). AC3	Termik Akım Ith (A) AC1	Yardımcı Kontak	Sipariş Kodu	Birim Fiyat (₺)	Kutu Adeti	
3 Kutuplu 220 V AC	NC6-0610M	2,2	6	20	1NA	247436	88,92	1
	NC6-0601M	2,2	6	20	1NK	247337	88,92	1
	NC6-0910M	4	9	20	1NA	247568	93,60	1
	NC6-0901M	4	9	20	1NK	247469	93,60	1
3 Kutuplu 24 V AC	NC6-0610M	2,2	6	20	1NA	247445	94,73	1
	NC6-0601M	2,2	6	20	1NK	247346	94,73	1
	NC6-0910M	4	9	20	1NA	247576	105,40	1
	NC6-0901M	4	9	20	1NK	247478	105,40	1
Yardımcı Kontak Bloğu	NCF6-20			10	2NA	261006	53,20	2
	NCF6-02			10	2NK	261002	53,20	2
	NCF6-11			10	1NA+1NK	261004	53,20	2
	NCF6-40			10	4NA	261009	67,99	2
	NCF6-04			10	4NK	261003	67,99	2
	NCF6-22			10	2NA+2NK	261007	67,99	2
	NCF6-13			10	1NA+3 NK	261005	67,99	2
	NCF6-31			10	3NA+1 NK	261008	67,99	2
Mini Termik	NR2-11.5/0.16			0.1-0.16 A	1NA+1NK	268165	159,20	2
	NR2-11.5/0.25			0.16-0.25A	1NA+1NK	268166	159,20	2
	NR2-11.5/0.4			0.25-0.4 A	1NA+1NK	268167	159,20	2
	NR2-11.5/0.63			0.4-0.63A	1NA+1NK	268168	159,20	2
	NR2-11.5/1			0.63-1 A	1NA+1NK	268169	159,20	2
	NR2-11.5/1.6			1.0-1,6 A	1NA+1NK	268170	159,20	2
	NR2-11.5/2			1.25-2 A	1NA+1NK	268171	159,20	2
	NR2-11.5/2.5			2.0-2.5 A	1NA+1NK	268172	159,20	2
	NR2-11.5/4			2.5-4 A	1NA+1NK	268173	159,20	2
	NR2-11.5/6			4-6 A	1NA+1NK	268174	159,20	2
	NR2-11.5/8			7-10 A	1NA+1NK	268175	159,20	2
	NR2-11.5/10			7-10 A	1NA+1NK	268176	159,20	2
	NR2-11.5/13			9-13 A	1NA+1NK	268177	159,20	2

Uyumlu Termik

Birim Fiyat (₺)
(2 li Kutu)

DIN raya Montaj Bloğu	NAD-11.5			NR2-11.5	837999	70,93	1
-----------------------	----------	--	--	----------	--------	-------	---



NS2X Serisi Motor Koruma Şalterleri

Termik Manyetik



Ürün Tanımı	Anma Gücü P(kW). 400 V AC	Kesme Kap. Icu (kA).400 V AC	Termik Akım Ith (A) AC1	Sipariş Kodu	Birim Fiyat (₺)	
3 Kutuplu 220 V AC	NS2-25X	-	100	0.1-0.16 A	495176	211,20
		-	100	0.16-0.25 A	495177	211,20
		-	100	0.25-0.4 A	495178	211,20
		-	100	0.4-0.63 A	495179	223,40
		--	100	0.63-1 A	495180	223,40
		0.37	100	1-1.6 A	495181	223,40
		0.75	100	1.6-2,5 A	495182	223,40
		1,5	100	2,5-4 A	495183	223,40
		2,2	100	4-6,3 A	495184	232,50
		4,0	100	6-10 A	495185	232,50
		5,5	15	9-14 A	495186	235,30
		7,5	15	13-18 A	495187	241,40
		11,0	15	17-23 A	495188	247,40
		11,0	15	20-25 A	495189	247,40
15,0	15	24-32 A	139373	366,40		
NS2-80B	18,5	15	25-40 A	495087	697,60	
	30,0	15	40-63 A	495088	743,30	
	37,0	15	63-80 A	495089	1.030,00	

NS2 Serisi Motor Koruma Şalterleri Aksesuarları

		Çalışma Sahası	Gerilim	Sipariş Kodu	Birim Fiyat (₺)
Düşük Gerilim Açtırma	NS2-UV380	- %35-%70	380V	495989	128,00
	NS2-UV220	%35-%70	220V	495986	128,00
Uzaktan Açtırma	NS2-SH380	- %70-%110	380V	495980	128,00
	NS2-SH220	%70-%110	220V	495977	128,00
Yardımcı Kontak üstüne Montaj	NS2-AE20	- 2NA	2.5A	495948	45,99
	NS2-AE11	1NA+1 NK	2.5A	495968	45,99
Yardımcı Kontak sağ/ sola Montaj	NS2-AU20	- 2NA	6A	495951	71,85
	NS2-AU11	1NA+1 NK	6A	495996	71,85
	NS2-80B-AU11	1NA+1 NK	6A	495972	71,85
Hata ve Ani Açtırma Kontakları-sola Montaj	NS2-FA0110	- 1NA+1 NK	6A	495956	77,58
	NS2-FA1010	1NA+1 NK	6A	495962	77,58
IP Sınıfı Yüksek Kutular	NS2-MC01	Suya Karşı Koruma Sınıfı Yüksek stop Butonlu Kutu		495945	202,30
	NS2-MC	Suya Karşı Kouması Yüksek		495997	158,40



NQ3 Serisi Kutulu Yolvericiler

Termik Korumalı



Ürün Tanımı	Anma Gücü P(kW). 400 V AC	Ayar Sahası	Sipariş Kodu	Birim Fiyat (₺)	
400 VAC 50/60 Hz (Kontrol Gerilimi 380 V AC)	NQ3-5.5P 380 V/1.6A	-	1-1,6	496436	393,60
	NQ3-5.5P 380 V/2.5A	-	1,6-2,5	496440	393,60
	NQ3-5.5P 380 V/4A	-	2,5-4	496442	393,60
	NQ3-5,5 P 380 V/6A	5,5	4-6,0	496443	409,30
	NQ3-5,5 P 380 V/8A	5,5	5,5-8	496444	409,30
	NQ3-5,5 P 380 V/10A	5,5	7-10,0	496437	409,30
	NQ3-5.5 P 380 V/13A	5,5	9-13,0	496438	409,30
	NQ3-11/2 380 V/18A	11	12-18,0	496359	555,30
NQ3-11/3 380 V/25 A	11	17-25	496361	555,30	
400 VAC 50/60 Hz (Kontrol Gerilimi 220 V AC)	NQ3-5.5P 220 V/1.6A	-	1-1,6	496399	393,60
	NQ3-5.5P 220 V/2.5A	-	1,6-2,5	496403	393,60
	NQ3-5,5P 220 V/4A	-	2,5-4	496405	393,60
	NQ3-5,5 P 220 V/6A	5,5	4-6,0	496406	409,30
	NQ3-5,5 P220 V/8A	5,5	5,5-8	496407	409,30
	NQ3-5,5 P 220 V/10A	5,5	7-10,0	496400	409,30
	NQ3-5.5 P 220 V/13A	5,5	9-13,0	496401	409,30
	NQ3-11/2 220 V/18A	11	12-18,0	496332	555,30
NQ3-11/3 220 V/25 A	11	17-25	496334	555,30	



Bağlantı Şeması

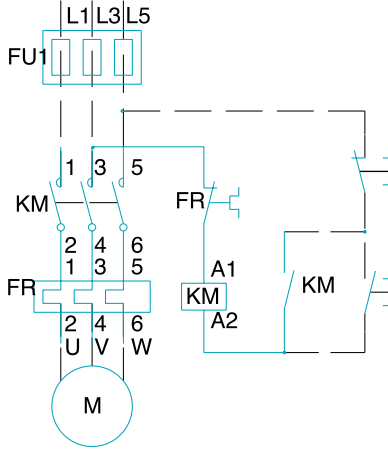

Kontrol beslemesi kaynaktan

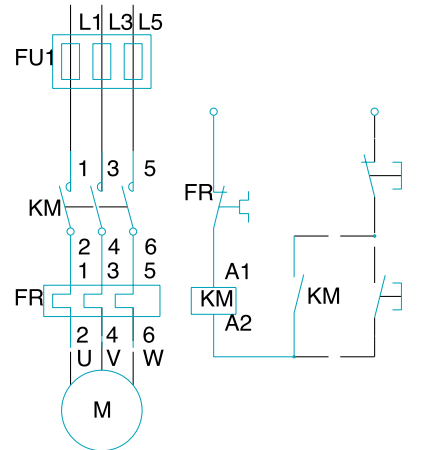

Kontrol beslemesi dışardan

Boyutlar

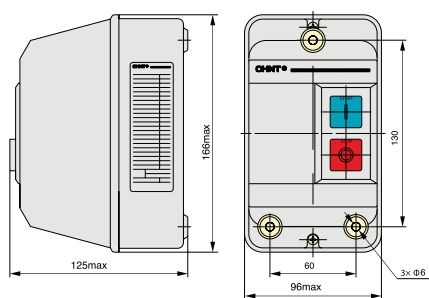

NQ3-5.5P

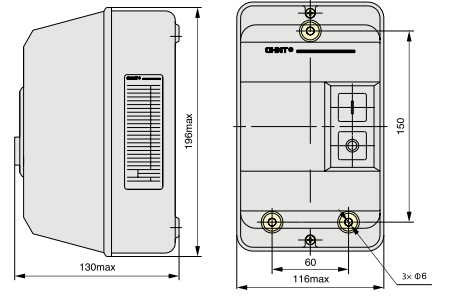

NQ3-11P

NJDC Test Butonlu Endüstriyel Röle

2 Kontaklı 8 Pinli 7.5A

Ürün Tanımı	Sipariş Kodu	Birim Fiyat (₺)	Kutu Adeti
NJDC-12/2Z DC12V	651112	62,07	10
NJDC-12/2Z DC24V	651114	62,07	10
NJDC-12/2Z DC110V	651111	62,07	10
NJDC-12/2Z DC220V	651113	62,07	10
NJDC-12/2 AC24V	651109	62,07	10
NJDC-12/2 AC110V	651107	62,07	10
NJDC-12/2 AC220V	651108	62,07	10
NJDC-12/2 AC380V	651110	62,07	10



3 Kontaklı 11 Pinli 7.5A

Ürün Tanımı	Sipariş Kodu	Birim Fiyat (₺)	Kutu Adeti
NJDC-12/3Z DC12V	651120	70,93	10
NJDC-12/3Z DC24V	651122	70,93	10
NJDC-12/3Z DC110V	651119	70,93	10
NJDC-12/3Z DC220V	651121	70,93	10
NJDC-12/3 AC24V	651117	70,93	10
NJDC-12/3 AC110V	651115	70,93	10
NJDC-12/3 AC220V	651116	70,93	10

NJDC Endüstriyel Röle ve Soketleri

Yüksek Akım Kapasitesi | 10 A, 8 Bacaklı Test Butonlu



Ürün Tanımı	Sipariş Kodu	Birim Fiyat (₺)
JQX-10F 2Z İçin 8 Pinli soket CZF08A	146140	11,68
JQX-10F 2Z İçin 8 Pinli soket CZF08A-E	146141	13,31
JQX-10F 3Z İçin 11 Pinli soket CZF11A	146142	16,26
JQX-10F 3Z İçin 11 Pinli soket CZF11A-E	146143	17,00



ND16 Plastik Seri Sinyal Lambası (LED)



Ürün Tanımı	24/230 V AC	Renk	Sipariş Kodu	Birim Fiyat (₺)	Kutu Adeti
Açılı Kafalı Kısa Gövde 1NA	22DS/2 24V	Beyaz	592936	10,86	10
		Turuncu	593154	10,86	10
		Kırmızı	592938	10,86	10
		Sarı	592939	10,86	10
		Mavi	592937	10,86	10
		Yeşil	592940	10,86	10
Açılı Kafalı Kısa Gövde 1NA	22DS/4 220V	Kırmızı	592718	10,86	10
		Sarı	592719	10,86	10
		Yeşil	592720	10,86	10



Buzzer

Ürün Tanımı	Sipariş Kodu	Birim Fiyat (₺)	Kutu Adeti
ND-16F Kırmızı 22mm Kesintili Çalışmalı 230V AC	593391	38,62	10
ND-16F Kırmızı 22mm Kesintili Çalışmalı 24 V AC/DC	593381	38,62	10



NP2 Serisi 22mm Metal Seri Buton ve Sinyal Lambası

AC/DC korumalı LED grubu



	Ürün Tanımı 220/380 V AC	Kontakt	Renk	Sipariş Kodu	Birim Fiyat (₺)	Kutu Adeti
Yaylı Buton		1NA	Beyaz	573954	22,47	10
		1NA	Siyah	573955	22,47	10
		1NA	Yeşil	573956	22,47	10
		1NA	Sarı	573959	22,47	10
		1NA	Mavi	573892	22,47	10
		40mm Mantar	1NA	Siyah	573969	33,79
Acil Stop Butonu 40 mm		1NK	Kırmızı	573894	38,08	10
İkiz Buton	Start/Stop	1NA+1NK	Yeşil+Kırmızı	574004	41,00	10
	Start/Stop/Işıklı LED'li 24 V	1NA+1NK	Yeşil+Kırmızı	574368	67,36	10
	Start/Stop/Işıklı LED'li 220V	1NA+1NK	Yeşil+Kırmızı	574909	67,36	10
Işıklı yaylı Buton, LED'li 24 VAC		1NA+1NK	Beyaz	574337	46,87	10
		1NA+1NK	Yeşil	574340	46,87	10
		1NA+1NK	Kırmızı	574343	46,87	10
		1NA+1NK	Sarı	574346	46,87	10
		1NA+1NK	Mavi	574349	46,87	10
Işıklı Yaylı Buton, LED'li 220 V AC/DC		1NA+1NK	Beyaz	574364	46,87	10
		1NA+1NK	Yeşil	575642	46,87	10
		1NA+1NK	Kırmızı	575643	46,87	10
		1NA+1NK	Sarı	575647	46,87	10
		1NA+1NK	Mavi	574367	46,87	10
Plastik Korumalı, Yaylı Buton		1NA	Siyah	575875	25,18	10
		1NA	Yeşil	575876	25,18	10
		1NA	Sarı	575877	25,18	10
		1NK	Kırmızı	575878	25,18	10
Mandal Buton	2 Konum Kalıcı	1NA	Siyah	573977	26,35	10
	3 Konum Kalıcı	1NA+1NK	Siyah	574658	35,14	10
	3 Konum geriye Yaylı	1NA+1NK	Siyah	574659	38,08	10
Uzun Mandal Buton	2 Konum Kalıcı	1NA	Siyah	573992	26,35	10
	3 Konum Kalıcı	1NA+1NK	Siyah	574209	38,08	10
	3 Konum geriye Yaylı	1NA+1NK	Siyah	574653	41,00	10
Kilit Buton	2 Konumlu	1NA	Siyah	573986	46,87	10
	3 Konumlu, Kilit Her Yönde	1NA+1NK	Siyah	574657	58,57	10
	3 Konumlu, Kilit Ortada	1NA+1NK	Siyah	574654	58,57	10
Sinyal Lambası, LED'li 220 V AC/DC			Beyaz	574386	29,25	10
			Yeşil	574048	29,25	10
			Kırmızı	574049	29,25	10
			Sarı	574050	29,25	10
			Mavi	575623	29,25	10
Sinyal Lambası, LED'li 24 V AC/DC			Beyaz	574331	29,25	10
			Yeşil	574045	29,25	10
			Kırmızı	574046	29,25	10
			Sarı	574047	29,25	10
			Mavi	575218	29,25	10



NP2 Serisi 22mm Plastik Seri Buton ve Sinyal Lambası

AC/DC korumalı LED grubu

	Ürün Tanımı 220/380 V AC	Kontakt	Renk	Sipariş Kodu	Birim Fiyat (₺)	Kutu Adeti
	Yaylı Buton	1NA	Beyaz	574576	13,63	10
		1NA	Siyah	574084	13,63	10
		1NA	Yeşil	574085	13,63	10
		1NA	Sarı	574086	13,63	10
		1NA	Mavi	574087	13,63	10
		1NK	Kırmızı	574628	13,63	10
		40mm Mantar	1 NK	Siyah	574092	20,49
	Acil Stop Butonu 40 mm	1NK	Kırmızı	574120	24,16	10
	İkiz Buton	Start/Stop	1NA+1NK	Yeşil+Kırmızı	575281	29,30
		Start/Stop/Işıklı LED'li 24 V	1NA+1NK	Yeşil+Kırmızı	575439	52,71
		Start/Stop/Işıklı LED'li 220V	1NA+1NK	Yeşil+Kırmızı	575343	52,71
	Işıklı yaylı Buton, LED'li 24 VAC/DC	1NA+1NK	Beyaz	575306	42,49	10
		1NA+1NK	Yeşil	575316	42,49	10
		1NA+1NK	Kırmızı	575330	42,49	10
		1NA+1NK	Sarı	575336	42,49	10
		1NA+1NK	Mavi	575342	42,49	10
	Işıklı Yaylı Buton, LED'li 220 V AC/DC	1NA+1NK	Beyaz	575644	42,49	10
		1NA+1NK	Yeşil	574164	42,49	10
		1NA+1NK	Kırmızı	575645	42,49	10
		1NA+1NK	Sarı	574163	42,49	10
		1NA+1NK	Mavi	575447	42,49	10
	Mandal Buton	2 Konum Kalıcı	1NA	Siyah	574095	23,43
		3 Konum Kalıcı	1NA+1NK	Siyah	575423	32,22
		3 Konum geriye Yaylı	1NA+1NK	Siyah	575558	35,14
	Uzun Mandal Buton	2 Konum Kalıcı	1NA	Siyah	574108	23,43
		3 Konum Kalıcı	1NA+1NK	Siyah	575424	32,22
		3 Konum geriye Yaylı	1NA+1NK	Siyah	576025	35,14
	Kilit Buton	2 Konumlu	1NA	Siyah	574102	38,08
		3 Konumlu, Kilit her Yönde.	1NA+1NK	Siyah	575964	46,87
		3 Konumlu, Kilit Ortada	1NA+1NK	Siyah	576027	46,87
	Sinyal lambası, LED'li 220 V AC/DC		Beyaz	574798	23,43	10
			Yeşil	574582	23,43	10
			Kırmızı	574583	23,43	10
			Sarı	574668	23,43	10
			Mavi	574683	23,43	10
	Sinyal Lambası, LED'li 24 V AC/DC		Beyaz	575296	23,43	10
			Yeşil	574629	23,43	10
			Kırmızı	574142	23,43	10
			Sarı	575299	23,43	10
			Mavi	575300	23,43	10

NP2 Serisi Butonlar için Yardımcı Aksesuarlar

Ürün Tanımı 220/380 V AC	Kontakt	Renk	Sipariş Kodu	Birim Fiyat (₺)	Kutu Adeti
İlave Kontakt	1NA		576841	14,65	50
İlave Kontakt	1NK		576842	14,65	50
Pano Etiketi			576794	2,92	80
Sarı Renk Dairesel Etiket (Acil Durdurma)			576785	4,98	80



NP8 Serisi 22mm Krom Gövde Seri Buton ve Sinyal Lambası













	Ürün Tanımı 220/380 V AC	Kontakt	Renk	Sipariş Kodu	Birim Fiyat (₺)	Kutu Adeti
		1NA	Beyaz	578646	35,14	10
		1NA	Siyah	578647	35,14	10
		1NA	Yeşil	667232	35,14	10
		1NA	Sarı	667333	35,14	10
		1NA	Mavi	578645	35,14	10
		1NK	Kırmızı	667231	35,14	10
		40mm Mantar	1NA	Siyah	578935	43,92
	Acil Stop Butonu 40 mm	1NK	Kırmızı	667210	52,71	10
	Start/Stop	1NA+1NK	Yeşil+Kırmızı	667178	58,57	10
	Start/Stop/Işıklı LED'li 24 VAC/DC & 220 VAC	1NA+1NK	Yeşil+Kırmızı	667173	123,10	10
	Işıklı Yaylı Buton, LED'li 24 VAC/ DC & 220 VAC	1NA	Beyaz	578662	73,22	10
		1NA	Yeşil	667251	73,22	10
		1NA	Kırmızı	667252	73,22	10
		1NA	Sarı	667321	73,22	10
		1NA	Mavi	578663	73,22	
	2 Konum Kalıcı	1NA	Siyah	578661	46,87	10
	3 Konum Kalıcı	1NA+1NK	Siyah	667137	67,36	10
	Işıklı Mandal Buton, 2 Konum Kalıcı 24VAC/DC & 220VAC	1NA+1NK	Yeşil	667149	108,40	10
		1NA+1NK	Kırmızı	667150	108,40	10
		1NA+1NK	Sarı	667151	108,40	10
	Işıklı Mandal Buton, 3 Konum Kalıcı 24VAC/DC & 220VAC	1NA+1NK	Yeşil	667161	117,20	10
		1NA+1NK	Kırmızı	667162	117,20	10
		1NA+1NK	Sarı	667163	117,20	10
	2 Konumlu	1NA		578130	49,79	10
	3 Konumlu, Kilit her Yönde.	1NA+1NK		667183	76,14	10
	Sinyal Lambası, LED'li 24 VAC/DC & 220 VAC		Beyaz	578991	67,36	10
			Yeşil	667107	67,36	10
			Kırmızı	667108	67,36	10
			Sarı	578651	67,36	10
			Mavi	578642	67,36	10













Siparişte Sinyal Lambası Gerilim Seviyesi mutlaka bildirilmelidir.
24V, 48V, 110V, 220V AC
24V, 48V, 110V, 220V DC



NP2 Kutular

Esnek Çözüm

	Sipariş Kodu	Birim Fiyat (₺)
	573891	41,77
	575576	56,69
	575577	68,62
	575575	68,62
	573927	89,51
	573928	89,51
	573929	89,51
	573930	89,51
	573931	89,51
	573933	89,51
	574878	101,50
	573937	101,50
	573936	101,50

	Sipariş Kodu	Birim Fiyat (₺)
	574165	101,50
	574166	101,50
	573938	125,40
	573939	125,40
	573940	125,40
	573941	154,00
	573945	154,00
	573946	154,00
	573947	154,00
	573949	154,00
	573944	154,00
	573950	154,00



Zaman Röleleri | Elektronik | DIN Ray Tip



Ürün Tanımı	Zaman Aralığı	Uygulama		Teknik Özellikler								Çalışma Gerilimi			Sipariş Kodu	Birim Fiyat (₺)
		Kademe Sayısı	Ray Tipi / İnce (22,5)	Çekmede Gecikmeli (Delay ON)	Bırakmada Gecikmeli (Delay OFF)	Çift Zaman Ayanı	Yıldız - Üçgen	Simetrik Flaşör	Tetiklemeli	Açık Flaşör (ON)	Kapalı Flaşör (OFF)	24 V AC/DC	220V AC	Universal 24-220 VAC/DC 12 VAC/DC		
DN-T01 Zaman Rölesi	0,1 - 30 sn		●	●	●							●	●		500308	83,57
DN-T02 Zaman Rölesi	0,1 sn - 60 sn		●	●	●	●						●	●		500309	85,80
DN-T03 Çok Fonksiyonlu Zaman Rölesi	0,06 sn - 30 saat	7	●	●	●	●				●	●	●	●		500310	111,50
DN-T04 Çok Fonksiyonlu Zaman Rölesi	0,6 sn - 10 saat	6	●					●		●	●	●	●		500311	133,80
DN-T05 Çok Fonksiyonlu Zaman Rölesi	0,05 - 100 saat	7	●	●	●				●	●	●		●		500312	167,20
DN-SD Yıldız-Üçgen Rölesi	Y: 3 sec -30 sec Y→Δ:50...500msec.		●					●	●				●		500313	124,90

Gerilim Koruma Röleleri | Elektronik | DIN Ray Tip



Ürün Tanımı	Uygulama		Teknik Özellikler								Çalışma Gerilimi		Sipariş Kodu	Birim Fiyat (₺)
	Ray Tipi / İnce (22,5)	Ray Tipi / Normal (35)	Led Göstergeli Ekran	Tek Faz	3 Faz	Açık Gerilim Ani Açma (Un*1,5)	Düşük Gerilim Ani Açma (Un*0,5)	Faz Sırası	Faz Yokluğu	Çekme Gecikmesi (t-on)	Açma/Bırakma Gecikmesi (t-off)	220 Vac ± % 35		
DN-VP01 Gerilim Koruma Rölesi		●	●	●		●	●		●	X (1 sn. - 20 sn.)	X (1 sn. - 20 sn.)	●	500314	183,90
DN-VP02 Gerilim Koruma Rölesi	●		●	●		●	●		●		X (1 sn. - 20 sn.)	●	500315	183,90
DN-VP03 Gerilim Koruma Rölesi	●		●	●	●	●	●	●	●		X (1 sn. - 20 sn.)	●	500316	183,90
DN-VP04 Gerilim Koruma Rölesi	●		●	●		●	●		●	X (3 dk.)	X (0,1 sn. - 20 sn.)	●	500317	183,90
DN-VP05 Gerilim Koruma Rölesi	●		●	●	●	●	●	●	●	X (3 dk.)	X (0,1 sn. - 20 sn.)	●	500318	183,90

Motor (Faz) Koruma Röleleri | Elektronik | DIN Ray Tip

Ürün Tanımı	Uygulama		Ölçüm ve Teknik Özellikler						Besleme		Sipariş Kodu	Birim Fiyat (₺)
	Ray Tipi / İnce (22,5)	Manuel Gösterge Ekran	Nötr-Kopması Algılaması	Faz Sırası Korumalı	Asimetri Ayarlı	Asimetre Aralığı	Faz - Faz	Faz - Nötr	Açma/Bırakma Gecikmesi (t-off)	3 Faz - Nötr		
DN-MP01 Motor (Faz) Koruma Rölesi	●	●	●			30%		●		●	500319	111,50
DN-MP02 Motor (Faz) Koruma Rölesi	●	●	●	●	●	%5 - %15	●		X (0,1 sn. - 10 sn.)	●	500320	167,20

Sıvı Seviye Kontrol Röleleri | Elektronik | DIN Ray Tip



Ürün Tanımı	Uygulama		Ölçüm ve Teknik Özellikler				Besleme		Sipariş Kodu	Birim Fiyat (₺)
	Ray Tipi / İnce (22,5)	Led Göstergeli	2-100 kQ İletkenlik Ayarı	Boy: 150 mm Ø: 26 mm	Boy: 90 mm Ø: 19 mm"	220 VAC ± %20 (L-N)				
DN-L01 Sıvı Seviye Kontrol Rölesi	●	●	●					500321	124,90	
SE-L01 Küçük Elektrod						●		500322	16,71	
BE-L01 Büyük Elektrod						●		500323	22,29	



0-1 Aç/Kapa Pako Şalterler

Ürün serisi	Kutup sayısı	Akım	Kod Detayı	
			Tip	Model
CSL	*P	***A	01: Aç/kapa tip	S : Emniyet- sarı kırmızı kilittli çerçeve
			02: 1-0-2 kutup deęiřtirici tip	Boř: -

Ürün Tanımı	Faz/Kutup Sayısı	Nominal Akım(A)	Sipariş Kodu	Birim Fiyat (₺)
CSL-1P010A01	1	10	500370	35,10
CSL-1P016A01	1	16	500371	41,23
CSL-1P025A01	1	25	500372	50,14
CSL-1P040A01	1	40	500373	69,87
CSL-1P063A01	1	63	500374	81,79
CSL-1P080A01	1	80	500375	91,71
CSL-2P010A01	2	10	500376	46,58
CSL-2P016A01	2	16	500377	51,70
CSL-2P025A01	2	25	500378	60,62
CSL-2P040A01	2	40	500379	93,16
CSL-2P063A01	2	63	500380	109,10
CSL-2P080A01	2	80	500381	132,40
CSL-3P010A01	3	10	500382	55,60
CSL-3P016A01	3	16	500383	62,62
CSL-3P025A01	3	25	500384	72,99
CSL-3P040A01	3	40	500385	111,90
CSL-3P063A01	3	63	500386	130,90
CSL-3P080A01	3	80	500132	181,50
CSL-4P010A01	4	10	500133	81,57
CSL-4P016A01	4	16	500134	88,59
CSL-4P025A01	4	25	500135	104,90
CSL-4P040A01	4	40	500136	156,20
CSL-4P063A01	4	63	500137	167,80
CSL-4P080A01	4	80	500138	224,00
CSL-5P010A01	5	10	500139	83,91
CSL-5P016A01	5	16	500140	90,82
CSL-5P025A01	5	25	500141	110,60
CSL-5P040A01	5	40	500142	167,80
CSL-5P063A01	5	63	500143	193,90
CSL-5P080A01	5	80	500144	295,30
CSL-6P010A01	6	10	500145	93,16
CSL-6P016A01	6	16	500146	99,40
CSL-6P025A01	6	25	500147	117,60
CSL-6P040A01	6	40	500148	203,60
CSL-6P063A01	6	63	500149	248,90
CSL-6P080A01	6	80	500150	352,30



* 80A ve üzeri talepleriniz için üretim yapılabilir.

* Her tip pako şalter için uygun kutu mevcuttur.



Emniyet Tip Aç-Kapa Pako Şalterler



Ürün Tanımı	Faz/Kutup Sayısı	Nominal Akım(A)	Sipariş Kodu	Birim Fiyat (₺)
CSL-1P010A01S	1	10	500151	36,44
CSL-1P016A01S	1	16	500152	42,79
CSL-1P025A01S	1	25	500153	52,82
CSL-1P040A01S	1	40	500154	75,44
CSL-1P063A01S	1	63	500155	83,02
CSL-1P080A01S	1	80	500156	93,16
CSL-2P010A01S	2	10	500157	48,47
CSL-2P016A01S	2	16	500158	53,26
CSL-2P025A01S	2	25	500159	60,62
CSL-2P040A01S	2	40	500160	96,94
CSL-2P063A01S	2	63	500161	109,10
CSL-2P080A01S	2	80	500162	118,80
CSL-3P010A01S	3	10	500163	52,82
CSL-3P016A01S	3	16	500164	60,40
CSL-3P025A01S	3	25	500165	72,99
CSL-3P040A01S	3	40	500166	120,80
CSL-3P063A01S	3	63	500167	130,90
CSL-3P080A01S	3	80	500168	148,50
CSL-4P010A01S	4	10	500169	88,03
CSL-4P016A01S	4	16	500170	95,61
CSL-4P025A01S	4	25	500171	113,30
CSL-4P040A01S	4	40	500172	168,60
CSL-4P063A01S	4	63	500173	181,20
CSL-4P080A01S	4	80	500174	224,00
CSL-5P010A01S	5	10	500175	90,59
CSL-5P016A01S	5	16	500176	98,17
CSL-5P025A01S	5	25	500177	119,50
CSL-5P040A01S	5	40	500178	181,20
CSL-5P063A01S	5	63	500179	201,40
CSL-5P080A01S	5	80	500180	249,20
CSL-6P010A01S	6	10	500305	100,70
CSL-6P016A01S	6	16	500306	103,20
CSL-6P025A01S	6	25	500307	127,10
CSL-6P040A01S	6	40	500181	211,40
CSL-6P063A01S	6	63	500182	224,00
CSL-6P080A01S	6	80	500183	264,30

* 80A ve üzeri talepleriniz için üretim yapılabilir.

* Her tip pako şalter için uygun kutu mevcuttur.



1 - 0 - 2 Kademeli / Kutup Değişirici Pako Şalterler

Ürün Tanımı	Faz/Kutup Sayısı	Nominal Akım(A)	Sipariş Kodu	Birim Fiyat (₺)
CSL-1P010A02	1	10	500184	48,47
CSL-1P016A02	1	16	500185	53,26
CSL-1P025A02	1	25	500186	70,31
CSL-1P032A02	1	32	500187	87,25
CSL-1P040A02	1	40	500188	107,20
CSL-1P063A02	1	63	500189	138,10
CSL-1P080A02	1	80	500190	169,60
CSL-2P010A02	2	10	500191	69,87
CSL-2P016A02	2	16	500192	81,57
CSL-2P025A02	2	25	500193	93,16
CSL-2P040A02	2	40	500194	135,30
CSL-2P063A02	2	63	500195	162,20
CSL-2P080A02	2	80	500196	235,60
CSL-3P010A02	3	10	500197	86,25
CSL-3P016A02	3	16	500198	96,94
CSL-3P025A02	3	25	500199	116,40
CSL-3P032A02	3	32	500200	153,30
CSL-3P040A02	3	40	500201	196,30
CSL-3P063A02	3	63	500202	227,80

* İstenildiği takdirde diğer Amper talepli kutup deęiřtiriciler de üretilebilir.

* İstenildiği takdirde "1 - 2" kademeli řalterlerde üretilebilir.

* Her tip pako řalter için uygun kutu mevcuttur.



CSX Serisi 0-1 Aç/Kapa Pako Şalterler

Kod Detayı				
Ürün serisi	Kutup sayısı	Akım	Tip	Model
CSX	*P	***A	01: Aç/kapa tip	M:-
			02: 1-0-2 kutup değiştirici tip	TR:-
				SM:Emniyet- sarı kırmızı kilitleli çerçeve
				STR:Emniyet- sarı kırmızı kilitleli çerçeve

Ürün Tanımı	Faz/Kutup Sayısı	Nominal Akım(A)	Sipariş Kodu	Birim Fiyat (₺)
CSX-1P010A01M	1	10	500203	40,89
CSX-1P016A01M	1	16	500204	48,14
CSX-1P020A01M	1	20	500205	50,59
CSX-1P025A01M	1	25	500206	66,86
CSX-1P040A01M	1	40	500207	92,93
CSX-1P063A01TR	1	63	500208	111,70
CSX-1P080A01TR	1	80	500209	146,80
CSX-2P010A01M	2	10	500210	51,37
CSX-2P016A01M	2	16	500211	62,74
CSX-2P020A01M	2	20	500212	65,19
CSX-2P025A01M	2	25	500213	84,46
CSX-2P040A01M	2	40	500214	113,20
CSX-2P063A01TR	2	63	500215	144,40
CSX-2P080A01TR	2	80	500216	195,70
CSX-3P010A01M	3	10	500217	62,74
CSX-3P016A01M	3	16	500218	76,66
CSX-3P020A01M	3	20	500219	83,68
CSX-3P025A01M	3	25	500220	102,10
CSX-3P040A01M	3	40	500221	152,50
CSX-3P063A01TR	3	63	500222	201,20
CSX-3P080A01TR	3	80	500223	244,50
CSX-4P010A01M	4	10	500224	88,70
CSX-4P016A01M	4	16	500225	97,50
CSX-4P020A01M	4	20	500226	101,90
CSX-4P025A01M	4	25	500227	120,70
CSX-4P040A01M	4	40	500228	171,90
CSX-4P063A01TR	4	63	500229	234,80
CSX-4P080A01TR	4	80	500230	302,50
CSX-5P010A01M	5	10	500231	122,30
CSX-5P016A01M	5	16	500232	123,00
CSX-5P020A01M	5	20	500233	127,30
CSX-5P025A01M	5	25	500234	147,70
CSX-5P040A01M	5	40	500235	224,80
CSX-5P063A01TR	5	63	500236	270,20
CSX-5P080A01TR	5	80	500237	328,10
CSX-6P010A01M	6	10	500238	130,00
CSX-6P016A01M	6	16	500239	133,70
CSX-6P020A01M	6	20	500240	138,60
CSX-6P025A01M	6	25	500241	150,60
CSX-6P040A01M	6	40	500242	241,00
CSX-6P063A01TR	6	63	500243	286,60
CSX-6P080A01TR	6	80	500244	420,00





Emniyet Tip Aç-Kapa Pako Şalterler



Ürün Tanımı	Faz/Kutup Sayısı	Nominal Akım(A)	Sipariş Kodu	Birim Fiyat (₺)
CSX-1P010A01SM	1	10	500245	40,89
CSX-1P016A01SM	1	16	500246	48,14
CSX-1P020A01SM	1	20	500247	50,59
CSX-1P025A01SM	1	25	500248	66,86
CSX-1P040A01SM	1	40	500249	92,93
CSX-1P063A01STR	1	63	500250	111,70
CSX-1P080A01STR	1	80	500251	146,80
CSX-2P010A01SM	2	10	500252	53,37
CSX-2P016A01SM	2	16	500253	62,74
CSX-2P020A01SM	2	20	500254	65,19
CSX-2P025A01SM	2	25	500255	84,46
CSX-2P040A01SM	2	40	500256	113,20
CSX-2P063A01STR	2	63	500257	144,40
CSX-2P080A01STR	2	80	500258	195,70
CSX-3P010A01SM	3	10	500259	62,74
CSX-3P016A01SM	3	16	500260	76,66
CSX-3P020A01SM	3	20	500261	83,68
CSX-3P025A01SM	3	25	500262	102,10
CSX-3P040A01SM	3	40	500263	152,50
CSX-3P063A01STR	3	63	500264	201,20
CSX-3P080A01STR	3	80	500265	244,50
CSX-4P010A01SM	4	10	500266	96,83
CSX-4P016A01SM	4	16	500267	105,50
CSX-4P020A01SM	4	20	500268	109,80
CSX-4P025A01SM	4	25	500269	124,40
CSX-4P040A01SM	4	40	500270	186,20
CSX-4P063A01STR	4	63	500271	234,80
CSX-4P080A01STR	4	80	500272	302,50
CSX-5P010A01SM	5	10	500273	122,30
CSX-5P016A01SM	5	16	500274	123,00
CSX-5P020A01SM	5	20	500275	127,30
CSX-5P025A01SM	5	25	500276	147,70
CSX-5P040A01SM	5	40	500277	224,80
CSX-5P063A01STR	5	63	500278	270,20
CSX-5P080A01STR	5	80	500279	328,10
CSX-6P010A01SM	6	10	500280	130,00
CSX-6P016A01SM	6	16	500281	133,70
CSX-6P020A01SM	6	20	500282	138,60
CSX-6P025A01SM	6	25	500283	150,60
CSX-6P040A01SM	6	40	500284	241,00
CSX-6P063A01STR	6	63	500285	286,60
CSX-6P080A01STR	6	80	500286	420,00

* 80A ve üzeri talepleriniz için üretim yapılabilir.

* Her tip pako şalter için uygun kutu mevcuttur.



1 - 0 - 2 Kademeli / Kutup Değişirici Pako Şalterler



Ürün Tanımı	Faz/Kutup Sayısı	Nominal Akım(A)	Sipariş Kodu	Birim Fiyat (₺)
CSX-1P010A02M	1	10	500287	56,38
CSX-1P016A02M	1	16	500288	58,72
CSX-1P020A02M	1	20	500289	65,97
CSX-1P025A02M	1	25	500290	89,03
CSX-1P040A02M	1	40	500291	122,30
CSX-1P063A02TR	1	63	500292	155,40
CSX-1P080A02TR	1	80	500293	241,50
CSX-2P010A02M	2	10	500294	85,58
CSX-2P016A02M	2	16	500295	92,93
CSX-2P020A02M	2	20	500296	100,80
CSX-2P025A02M	2	25	500297	123,60
CSX-2P040A02M	2	40	500298	182,30
CSX-2P063A02TR	2	63	500299	231,50
CSX-2P080A02TR	2	80	500300	361,10
CSX-3P010A02M	3	10	500301	94,60
CSX-3P025A02M	3	25	500302	172,50
CSX-3P040A02M	3	40	500303	246,90
CSX-3P063A02TR	3	63	500304	322,50

* İstenildiği takdirde diğer Amper talepli kutup deęiřtiriciler de üretilebilir.

* İstenildiği takdirde "1 - 2 " kademeli şalterlerde üretilebilir.

* Her tip pako şalter için uygun kutu mevcuttur.

CHINT
CHINT ELECTRIC

Empower the World

Elektriğin kontrolü sizde!

Her durumda, maksimum koruma.

Chint, 36 yıllık deneyimiyle ürettiği otomatik sigortalar, kaçak akım koruma ürünleri ve parafudrlar ile evden fabrikaya tüm yapılarda güvenilir koruma sağlar.

3 Yıl
Garanti



Zengin yardımcı
aksesuar desteği



Teknik servis ve
destek hizmeti



Geniş ürün yelpazesi ile
eksiksiz ürün portföyü



Zorlu çevre
koşullarında sorunsuz
ve güvenilir çalışma



Montaj ve bakımı kolay
ergonomik tasarım



Otomatik Sigortalar

Kaçak Akım Röleleri

Parafudrlar



+90 216 621 00 55
www.chint.com.tr

CHNT
CHINT ELECTRIC

Empower the World

Sosyal Medya'da
Bizi Takip Edin!

 @chintturkiye

 @Chintgroupturca

 @chintturkiye



CHINT TURCA ELEKTRİK SANAYİ ve TİCARET A. Ş.

📍 Zümrütevler Mah. Ural Sok. No:22 Nas Plaza Kat: 1 No:18-19 Maltepe - İstanbul - Türkiye

☎ +90 216 621 00 55 / +90 216 621 00 50

✉ satis@chint.com.tr



Önemli Not: CHINT önceden haber verilmeksizin teknik değişiklikler yapma veya bu dokümanı çarpıcı değişiklikler hakkındaki hakları saklı tutmaktadır. Satışına ayrılmış, üzerinde herhangi bir değişiklik yapılmış ürünler CHINT tarafından kabul edilmez. Bu dokümanı ve ilgili kuru ile birlikte kullanırken herhangi bir sorunu bildirmenizi rica ederiz. CHINT'ın yazılı izni olmaksızın, her türlü kopyalama, çoğaltma, yayma, dağıtım veya çarpıtma yasaktır.