

CHINT

CHINT GLOBAL

FİYAT LİSTESİ TEMMUZ 2021

DÜNYADA CHINT

- 3 Dünya Çapında AR&GE Merkezi: Avrupa, Kuzey Amerika, Asya Pasifik
- 6 Uluslararası Pazarlama & Satış Alanı: Asya Pasifik, Orta Doğu ve Afrika, Avrupa, Latin Amerika, Kuzey Amerika, Çin
- 9 Üretim Tesisi: Çin (Wenzhou, Shanghai, Hangzhou, Xianyang, Jiuquan), Mısır, Almanya, Tayland
- 14 Uluslararası İştirak
- 17 Pazarlama Ofisi
- 22 Lojistik Merkezi
- 2300 Satış Şirketi

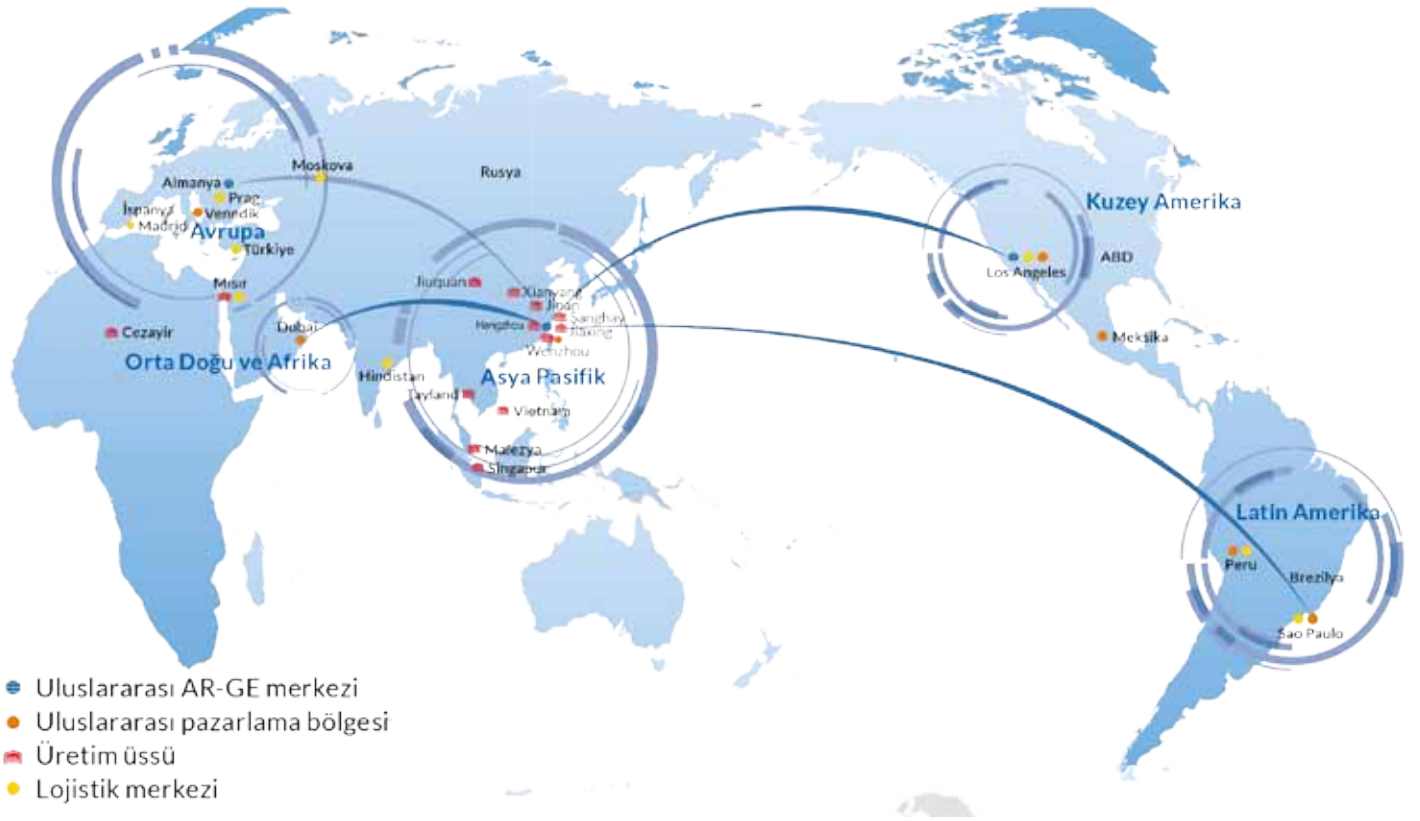

Ürünlerimizin sahip olduğu uluslararası sertifikalar:

TURKEY	EU	Netherland	Germany	Germany	Sweden	Finland	Czech	Indonesia	Ukraine	Russia	South Africa	USA	Canada	UK

CHINT - Akıllı Enerji Çözüm Ortağı



1984 yılında kurulan CHINT, 140'ın üzerinde ülkede ve bölgede, 30.000'den fazla çalışanıyla faaliyetlerini sürdürmektedir.

CHINT aktif olarak denizaşırı pazarlara açılmış, Avrupa, Kuzey Amerika ve Asya Pasifik'te 3 araştırma ve geliştirme (Ar-Ge) merkezi; Çin, Asya Pasifik, Avrupa, Batı Asya ve Afrika, Latin Amerika ve Kuzey Amerika'da 6 pazarlama ofisi; Almanya, Tayland, Malezya, Mısır, Singapur ve Vietnam'da da üretim üsleri kurmuştur. Küresel ticaretin sürekli ve istikrarlı bir şekilde büyümesini sağlamak amacıyla teknik ve ticari faaliyetlerini büyük bir titizlikle sürdürmektedir.

CHINT, küresel Ar-Ge sisteminin gelişimini aktif olarak teşvik ederek, 18 profesyonel teknoloji araştırma enstitüsü ve 3 denizaşırı Ar-Ge merkezlerine sahip

CHINT Group Araştırma Enstitüsü'nü kurmuş, endüstriyel gelişim ve inovasyon konseptine sadık kalmıştır. 4.000'den fazla patent lisansı almış ve 5.000 patent başvurusu yapmıştır. Ek olarak, 185 endüstriyel ve ulusal standardın oluşturulmasına öncülük etmiş; ulusal ve bölgesel boyutta olmak üzere 32 bilim ve teknoloji ödülü kazanmıştır.

CHINT, "elektrik enerjisini daha güvenli, çevreci, kullanışlı ve verimli hale getirmek" misyonuyla, insan odaklı ve değer paylaşımli kültürüne bağlı kalmıştır. CHINT'in kurum imajını çevrecilik, enerji tasarrufu, sürdürülebilir inovasyon ve güvenilirlik anlayışı oluşturmaktadır. Kurum kültürünü müşteri odaklılık ve inovasyonun oluşturduğu CHINT, her yıl ortaya koyduğu çift haneli büyüme rakamları ile global düzeyde kendini geliştirmekte ve yenilemeye devam etmektedir.

Ana iş kolları



Temiz Enerji



Enerji Depolama



Enerji İletimi ve Dağıtım



Enerji Tahsis



Alçak Gerilim Elektrik Ekipmanları



Enerji Katma Değerli Hizmetler



Akıllı Terminal



Büyük Veri



Yazılım Geliştirme



Kontrol Otomasyonu

	Otomatik Sigortalar	2-7
	eb Serisi Otomatik Sigortalar	2-3
	NXB ve NB7 Serisi Otomatik Sigortalar	4-5
	NB1 Serisi Otomatik Sigortalar	6
	DZ158 Serisi Otomatik Sigortalar	7
	NB1, NXB ve DZ158 Serileri Yardımcı Aksesuarlar	7
	Kaçak Akım Koruma Röleleri	8-10
	NL1 Serisi Kaçak Akım Koruma Röleleri RCCB	8-9
	NB1L Kaçak Akım Korumalı Otomatik Sigortalar - RCBO	10
	Alçak Gerilim Parafudrlar	11-12
	NU6 Alçak Gerilim Parafudrları	11
	Noark Ex9UE Alçak Gerilim Parafudrları	11-12
	Fotovoltaik Sistem Ürünleri	13
	Fotovoltaik Sistem Ürünleri	13
	Darbe Akım Anahtarları ve Modüler Kontaktörler	14-15
	NJMC1 Darbe Akım Anahtarları	14
	NCH8 Serisi Bina İçi Aydınlatma/Otomasyon Kontaktörü	15
	Zaman Röleleri	16
	NKG3 Dijital Zaman Saati	16
	KG316T Dijital Zaman Saati	16
	Yük Ayırıcılar	17-18
	NH4 Din Ray Tip Yük Ayırıcı	17
	NRT28-32 Kartuş ve Sigorta Yuvaları (gG/gL Hızlı Tip Sigorta)	17
	NHR17 Serisi Yatay Yük Ayırıcıları	18
	NHRT40 Dikey Yük Ayırıcı	18
	NH40 Serisi Yük Ayırıcıları	18
	Otomatik Transfer Şalterleri	19
	NXZ Serisi Otomatik Transfer Şalterleri	19
	Kompakt Tip Devre Kesiciler	21-26
	NXM Serisi Kompakt Tip Devre Kesiciler	21
	NXM Serisi Devre Kesiciler için Yardımcı Aksesuarlar	22
	NM8 Alçak Gerilim Devre Kesiciler	23-24
	NM8 Serisi Kompakt Tip Devre Kesiciler Aksesuarlar	25
	NXMLE Serisi Kaçak Akım Algılamalı Kompakt Tip Devre Kesiciler	26
	NM8L Kaçak Akım Korumalı Devre Kesiciler	26
	Açık Tip Devre Kesiciler	28-29
	NA1-X Serisi Açık Tip Devre Kesiciler ve Aksesuarları	28
	NA8G Serisi Açık Tip Devre Kesiciler	29

	Algilama Röleleri, Toroid ve Akım Trafoları	30
	Kaçak Akım Algılama Röleleri ve Toroidler	30
	Alçak Gerilim Güç Kalitesi Ürünleri	31-33
	AG Kuru Tip Kondansatörler	31
	Şönt Reaktörler ve Endüktif Yük Sürücüler	32
	CJ19 Serisi Kompanzasyon Kontaktörleri	33
	Harmonik Filtre Reaktörleri	33
	Motor Koruma ve Kontrol Ürünleri	35-45
	NC1 Serisi Kontaktörler	35-37
	NC1 Serisi Kontaktörler Aksesuarları	37
	NXC Serisi Kontaktörler	38
	NXC Serisi Yardımcı Aksesuarlar	38
	NC2 Serisi Kontaktörler ve Aksesuarları	39
	NC1 Uyumlu Termik Röleler	40
	NXC Uyumlu Termik Röleler	41
	NC2 Uyumlu Termik Röleler	41
	NXC Serisi Mini Kontaktörler	42
	NC6 Serisi Mini Kontaktörler	43
	NS2 Serisi Motor Koruma Şalterleri ve Aksesuarları	44
	NQ3 Serisi Kutulu Yolvericiler	45
	Endüstriyel Röle	46
	NJDC Endüstriyel Röle ve Soketleri	46
	Pano İklimlendirme Ekipmanları	46
	CN Serisi Pano İklimlendirme Ekipmanları	46
	Buton ve Sinyal Ürünleri	47-52
	EKO Serisi Ø22mm Plastik Seri Butonlar ve Sinyaller	47
	ND16 Plastik Seri Sinyal Lambası (LED)	48
	NP2 Serisi 22mm Metal Seri Buton ve Sinyal Lambası	49
	NP2 Serisi 22mm Plastik Seri Buton ve Sinyal Lambası	50
	NP8 Serisi 22mm Krom Gövde Seri Buton ve Sinyal Lambası	51
	NP2 Kutular	52
	MRT11 Serisi Röleler	53-54
	MRT11 Serisi Röleler	53-54
	CDM Serisi Dijital Multimetreler	54
	CDM Serisi Dijital Multimetreler	54
	Pako Şalterler	55-62
	CSL Serisi Pako Şalterler	55-58
	CSX Serisi Pako Şalterler	59-62





ÖNEMLİ NOTLAR:

- Fiyatlarımıza her an ihbara gerek duymaksızın değişiklik yapma hakkımız saklıdır.
- Teslim tarihindeki liste fiyatlarımız faturalamaya esastır.
- Fiyatlarımıza KDV dahil değildir.

- Listemiz dışındaki ürünler için tarafımızla temasa geçiniz.
- Resimler ve teknik veriler sadece bilgi amaçlıdır.
- Uygulamalarınızda kullanım kılavuzlarına riayet ediniz.





eB Serisi Otomatik Sigortalar

4.5 kA B | Hızlı Karakterli

	In (A) 230/400 V AC 50/60 Hz	Sipariş Kodu	Birim Fiyat (₺)	Kutu Adeti
1 Kutup 	1	186423	32,44	12
	2	186424	28,06	12
	3	186425	32,44	12
	4	186426	32,44	12
	6	186428	26,94	12
	10	186429	25,42	12
	16	186430	25,42	12
	20	186431	25,42	12
	25	186432	25,42	12
	32	186433	30,27	12
	40	186434	33,29	12
	50	186577	37,83	12
	63	186997	40,86	12
	2 Kutup 	1	186447	69,61
2		186448	69,61	6
3		186449	69,61	6
4		186450	72,64	6
6		186452	69,61	6
10		186453	62,56	6
16		186454	62,56	6
20		186455	62,56	6
25		186456	62,56	6
32		186457	70,37	6
40		186458	74,76	6
50		186571	77,94	6
63		187002	79,45	6
3 Kutup 		1	186507	112,00
	2	186508	112,00	4
	3	186509	112,00	4
	4	186510	112,00	4
	6	186512	112,00	4
	10	186513	95,33	4
	16	186514	95,33	4
	20	186515	95,33	4
	25	186516	95,33	4
	32	186517	104,50	4
	40	186518	107,50	4
	50	186562	126,20	4
	63	186996	140,20	4
	4 Kutup 	1	186519	143,90
2		186520	143,90	3
3		186521	143,90	3
4		186522	143,90	3
6		186524	143,90	3
10		186525	124,10	3
16		186526	124,10	3
20		186527	124,10	3
25		186528	124,10	3
32		186529	132,90	3
40		186530	154,20	3
50		186559	166,70	3
63		187003	188,30	3

eB Serisi Otomatik Sigortalar

4.5 kA C | Yavaş Karakterli

	In (A) 230/400 V AC 50/60 Hz	Sipariş Kodu	Birim Fiyat (₺)	Kutu Adeti
1 Kutup 	1	186411	28,78	12
	2	186412	28,78	12
	3	186413	28,78	12
	4	186414	28,78	12
	6	186416	28,68	12
	10	186417	25,42	12
	16	186418	25,42	12
	20	186419	25,42	12
	25	186420	25,42	12
	32	186421	30,27	12
	40	186422	33,29	12
	50	186576	37,83	12
	63	185639	40,10	12
	2 Kutup 	1	186459	79,10
2		186460	77,60	6
3		186461	77,60	6
4		186462	77,60	6
6		186464	67,33	6
10		186465	65,48	6
16		186466	65,48	6
20		186467	65,48	6
25		186468	65,48	6
32		186469	71,43	6
40		186470	75,97	6
50		186570	79,58	6
63		185640	89,02	6
3 Kutup 		1	186495	121,10
	2	186496	121,10	4
	3	186497	121,10	4
	4	186498	121,10	4
	6	186500	99,87	4
	10	186501	93,07	4
	16	186502	93,07	4
	20	186503	93,07	4
	25	186504	93,07	4
	32	186505	103,00	4
	40	186506	108,10	4
	50	186561	122,30	4
	63	185641	137,10	4
	4 Kutup 	1	186531	147,10
2		186532	147,10	3
3		186533	147,10	3
4		186534	147,10	3
6		186536	134,80	3
10		186537	129,70	3
16		186538	129,70	3
20		186539	129,70	3
25		186540	129,70	3
32		186541	139,40	3
40		186542	154,40	3
50		186557	166,70	3
63		186804	188,30	3

6 kA Otomatik Sigortalar

B | Hızlı Karakterli







NXB	In (A) 230/400 V AC 50/60 Hz	NXB		NB7		Kutu Adeti	NB7
		Sipariş Kodu	Birim Fiyat (₺)	Sipariş Kodu	Birim Fiyat (₺)		
1 Kutup	1	814034	40,34	192160	41,29	12	1 Kutup
	2	814035	40,34	192161	41,29	12	
	3	814036	40,34	192162	41,29	12	
	4	814037	40,34	192163	41,29	12	
	6	814038	35,55	192164	36,39	12	
	10	814039	29,33	192165	30,02	12	
	16	814040	29,33	192166	30,02	12	
	20	814041	29,33	192167	30,02	12	
	25	814042	29,33	192168	30,02	12	
	32	814043	34,72	192169	35,54	12	
	40	814044	38,51	192170	39,41	12	
	50	814045	43,31			12	
	63	814046	44,72			12	
2 Kutup	1	814112	88,87	192199	90,97	6	2 Kutup
	2	814113	88,87	192200	90,97	6	
	3	814114	88,87	192201	90,97	6	
	4	814115	88,87	192202	90,97	6	
	6	814116	80,72	192203	82,63	6	
	10	814117	74,06	192204	75,80	6	
	16	814118	74,06	192205	75,80	6	
	20	814119	74,06	192206	75,80	6	
	25	814120	75,54	192207	77,32	6	
	32	814121	85,91	192208	87,93	6	
	40	814122	88,87	192209	90,97	6	
	50	814123	97,81			6	
	63	814124	100,70			6	
3 Kutup	1	814190	129,00	192238	131,90	4	3 Kutup
	2	814191	129,00	192239	131,90	4	
	3	814192	129,00	192240	131,90	4	
	4	814193	129,00	192241	131,90	4	
	6	814194	123,90	192242	126,80	4	
	10	814195	106,70	192243	109,20	4	
	16	814196	106,70	192244	109,20	4	
	20	814197	106,70	192245	109,20	4	
	25	814198	108,20	192246	110,70	4	
	32	814199	124,40	192247	127,50	4	
	40	814200	150,80	192248	154,30	4	
	50	814201	160,80			4	
	63	814202	174,70			4	
4 Kutup	1	814268	177,90	192277	182,00	3	4 Kutup
	2	814269	177,90	192278	182,00	3	
	3	814270	177,90	192279	182,00	3	
	4	814271	177,90	192280	182,00	3	
	6	814272	165,90	192281	169,80	3	
	10	814273	148,20	192282	151,80	3	
	16	814274	148,20	192283	151,80	3	
	20	814275	148,20	192284	151,80	3	
	25	814276	148,20	192285	151,80	3	
	32	814277	170,50	192286	174,50	3	
	40	814278	177,90	192287	182,00	3	
	50	814279	191,60			3	
	63	814280	209,70			3	

6 kA Otomatik Sigortalar

C | Yavaş Karakterli







NXB	In (A) 230/400 V AC 50/60 Hz	NXB		NB7		Kutu Adeti	NB7
		Sipariş Kodu	Birim Fiyat (₺)	Sipariş Kodu	Birim Fiyat (₺)		
 1 Kutup	1	814008	40,76	192173	41,71	12	 1 Kutup
	2	814009	40,76	192174	41,71	12	
	3	814010	40,76	192175	41,71	12	
	4	814011	40,76	192176	41,71	12	
	6	814012	34,81	192177	35,63	12	
	10	814013	29,62	192178	30,32	12	
	16	814014	29,62	192179	30,32	12	
	20	814015	29,62	192180	30,32	12	
	25	814016	29,62	192181	30,32	12	
	32	814017	35,07	192182	35,90	12	
	40	814018	43,44	192183	44,47	12	
	50	814019	58,85	179624	60,24	12	
	63	814020	61,94	179626	63,39	12	
	 2 Kutup	1	814086	108,00	192212	110,60	
2		814087	108,00	192213	110,60	6	
3		814088	108,00	192214	110,60	6	
4		814089	108,00	192215	110,60	6	
6		814090	95,98	192216	98,24	6	
10		814091	95,98	192217	98,24	6	
16		814092	95,98	192218	98,24	6	
20		814093	95,98	192219	98,24	6	
25		814094	95,98	192220	98,24	6	
32		814095	102,00	192221	104,40	6	
40		814096	108,00	192222	110,60	6	
50		814097	171,40	179666	175,40	6	
63		814098	188,10	179668	192,70	6	
 3 Kutup		1	814164	150,80	192251	154,40	4
	2	814165	150,80	192252	154,40	4	
	3	814166	150,80	192253	154,40	4	
	4	814167	150,80	192254	154,40	4	
	6	814168	123,90	192255	126,80	4	
	10	814169	123,90	192256	126,80	4	
	16	814170	123,90	192257	126,80	4	
	20	814171	123,90	192258	126,80	4	
	25	814172	123,90	192259	126,80	4	
	32	814173	142,10	192260	145,40	4	
	40	814174	155,20	192261	158,90	4	
	50	814175	203,30	179708	208,10	4	
	63	814176	252,40	179710	258,50	4	
	 4 Kutup	1	814242	224,40	192290	229,60	3
2		814243	224,40	192291	229,60	3	
3		814244	224,40	192292	229,60	3	
4		814245	224,40	192293	229,60	3	
6		814246	187,90	192294	192,40	3	
10		814247	179,50	192295	183,90	3	
16		814248	179,50	192296	183,90	3	
20		814249	179,50	192297	183,90	3	
25		814250	179,50	192298	183,90	3	
32		814251	193,50	192299	198,10	3	
40		814252	219,20	192300	224,30	3	
50		814253	311,70	179750	319,00	3	
63		814254	333,40	179752	341,90	3	

*NB7 grubunda 50A ve 63A ürünler NB1 serisi olarak sevki edilmektedir.





NB1 Serisi Otomatik Sigortalar

10 kA C | Yavaş Karakterli

	In (A) 230/400 V AC 50/60 Hz	Sipariş Kodu	Birim Fiyat (₺)	Kutu Adeti
1 Kutup 	1	179781	73,80	12
	2	179785	73,80	12
	3	179788	73,80	12
	4	179790	73,80	12
	6	179793	60,96	12
	10	179782	57,75	12
	16	179784	57,75	12
	20	179786	57,75	12
	25	179787	57,75	12
	32	179789	59,04	12
	40	179791	67,64	12
	50	179792	74,00	12
	63	179794	83,65	12
	2 Kutup 	1	179823	172,80
2		179827	172,80	6
3		179830	172,80	6
4		179832	172,80	6
6		179835	174,20	6
10		179824	150,20	6
16		179826	150,20	6
20		179828	150,20	6
25		179829	150,20	6
32		179831	174,20	6
40		179833	180,30	6
50		179834	204,10	6
63		179836	228,20	6
3 Kutup 		1	179865	256,70
	2	179869	256,70	4
	3	179872	256,70	4
	4	179874	256,70	4
	6	179877	201,60	4
	10	179866	187,20	4
	16	179868	187,20	4
	20	179870	187,20	4
	25	179871	198,60	4
	32	179873	207,00	4
	40	179875	220,20	4
	50	179876	241,00	4
	63	179878	285,20	4
	4 Kutup 	1	179907	336,80
2		179911	336,80	3
3		179914	336,80	3
4		179916	336,80	3
6		179919	272,20	3
10		179908	259,20	3
16		179910	259,20	3
20		179912	259,20	3
25		179913	259,20	3
32		179915	262,10	3
40		179917	278,10	3
50		179918	384,90	3
63		179920	432,00	3

DZ158 Serisi Otomatik Sigortalar

10 kA | Yavaş Karakterli

	In (A) 230/400 V AC 50/60 Hz	Sipariş Kodu	Birim Fiyat (₺)	Kutu Adeti
1 Kutup 	63	158088	164,10	12
	80	158089	171,20	12
	100	158087	190,40	12
	125	158107	306,40	12
3 Kutup 	63	158094	363,50	4
	80	158095	540,80	4
	100	158093	571,00	4
	125	158109	629,00	4
4 Kutup 	63	158097	725,10	3
	80	158098	742,00	3
	100	158096	766,90	3
	125	158110	1.051,00	3



NXB Serisi Aksesuarlar

	Ürün Tanımı	Sipariş Kodu	Birim Fiyat (₺)	Kutu Adeti
İlave Bloklar 	NXB AX-X1 Yardımcı kontak	814991	83,84	14
	NXB AL-X1 Alarm kontak	814990	83,84	14
	NXB SHT-X1 Açtırma bobini 24V/48V AC/DC	814988	122,40	9
	NXB SHT-X1 Açtırma bobini 230V/400V AC	814989	122,40	9
	NXB UVT Düşük gerilim bobini	814987	181,20	9

NB1 Serisi Aksesuarlar

	Ürün Tanımı	Sipariş Kodu	Birim Fiyat (₺)	Kutu Adeti
İlave Bloklar 	S9 açtırma Bobini 220/380 V	184986	189,30	9
	S9 açtırma Bobini 24 V AC/DC	184985	189,30	9
	S9 açtırma Bobini 48 V AC/DC	184984	189,30	9
	V9 Düşük gerilim Bobini 220/380 V	184988	280,10	9
	F9 Yardımcı Kontak Bloğu 3A 1NA+1NK	184994	140,80	14
	F9J Alarm Kontak 3A, 1NA+1NK	184996	140,80	14

DZ Serisi Aksesuarlar



Ürün Tanımı 230/400 V AC 50/60 Hz	Sipariş Kodu	Birim Fiyat (₺)	Kutu Adeti
AX-1 yardımcı Kontak Bloğu 3A, 1NA+1NK	158999	127,30	12



NL1 Serisi Kaçak Akım Röleleri

AC ve A Tipi | DIN Ray Tipi

AC Tipi (6kA)

Anlık ya da yavaşça artan AC kaçak akıma karşı gecikmesiz açma yapar.



	230/400 V AC 50/60 Hz	In (A)	Sipariş Kodu	Birim Fiyat (₺)
2 kutup	30mA	25 A	200212	211,40
		40 A	200213	212,20
		63 A	200214	242,40
		80 A	200277	328,80
		100A	200278	396,30
	300mA	25 A	200218	210,20
		40 A	200219	210,20
		63 A	200220	240,60
		80 A	200281	323,00
		100A	200282	362,70
4 kutup	30mA	25 A	200223	304,40
		40 A	200224	307,30
		63 A	200225	337,70
	300mA	25 A	200229	289,30
		40 A	200230	296,60
		63 A	200231	315,70
		80 A	200760	469,70
		100A	200758	528,40



A Tipi (10kA)

Anlık ya da yavaşça artan AC ve DC kaçak akımlarına karşı gecikmesiz açma yapar.



	230/400 V AC 50/60 Hz	In (A)	Sipariş Kodu	Birim Fiyat (₺)
2 kutup	30mA	25A	200584	316,40
		40A	200362	317,90
		63A	200363	336,00
4 kutup	30mA	25A	200368	405,70
		40A	200364	431,40
		63A	200365	494,10



AC-G Tipi (10kA)

Yavaşça artan AC kaçak akıma karşı, arıza noktasına en yakın konumdaki kaçak akım koruma rölesinin açmasını mümkün kılacak şekilde 10ms gecikmeli açma yapar.



	230/400 V AC 50/60 Hz	In (A)	Sipariş Kodu	Birim Fiyat (₺)
2 kutup	30mA	40A	200572	329,50
		63A	200575	339,50
	300mA	40A	200574	329,50
		63A	200577	329,50
4 kutup	30mA	40A	200578	585,00
		63A	200581	601,70
	300mA	40A	200580	450,60
		63A	200583	544,60



SI- A Tipi (6kA)

AC kaçak akım ve DC puls kaçak akımlara karşı koruma özelliği vardır. Harmonikler ve transient kaynaklı akım piklerinde açmaya karşı korumalıdır.





	230/400 V AC 50/60 Hz	In (A)	Sipariş Kodu	Birim Fiyat (₺)
2 kutup	30mA	25A	200629	375,60
		40A	200628	394,70
		63A	200627	503,70
	300mA	25A	200623	484,50
		40A	200622	519,90
		63A	200621	628,90
4 Kutup	30mA	25A	200638	519,90
		40A	200637	539,00
		63A	200636	683,40
	300mA	25A	200632	702,60
		40A	200631	702,60
		63A	200630	882,30



NB1L Kaçak Akım Korumalı Otomatik Sigortalar (6kA C)

Elektronik | DIN ray tipi

Kaçak akım korumalı otomatik sigortalar, kaçak akım rölesi ve termik manyetik devre kesiciden oluşan ürünlerdir.

	In (A)	Sipariş Kodu	Birim Fiyat (₺)	
 2 Kutup 30 mA	6	197967	317,90	
	10	197931	317,90	
	16	197935	317,90	
	20	197943	317,90	
	25	197947	317,90	
	32	197955	317,90	
	40	197963	333,20	
 4 Kutup 300mA	10	198105	634,90	
	16	198109	634,90	
	20	198117	634,90	
	25	198121	634,90	
	32	198129	654,30	
	40	198137	725,50	
	NB1L-40H Serisi 4 Kutup 40 A 10kA A Tipi Kaçak Akımlı DC Pulse Kesme			198315



NU6 Alçak Gerilim Parafudrları

NU6-IIG/F Serisi

Tip 1 (Sayaç öncesi, ana dağıtım panosu)

Ürün Tanımı	Tip	Kutup Sayısı	Sürekli Çalışma Gerilimi Uc (V)	Imax (kA)	Up (kV)	Sipariş Kodu	Birim Fiyat (₺)
NU6-IIG/F T1 100kA 385V 3P+N	Tip 1	3 Kutup + Nötr	385	100	2,5	252564	3.773,00

Tip 2 (Sayaç sonrası, tali pano)

Ürün Tanımı	Tip	Kutup Sayısı	Sürekli Çalışma Gerilimi Uc (V)	Imax (kA)	Up (kV)	Sipariş Kodu	Birim Fiyat (₺)
NU6-IIG/F T2 20kA 320V 1P	Tip 2	1 Kutup	275	40	1,5	252499	237,70
NU6-IIG/F T2 20kA 320V 1P+N	Tip 2	1 Kutup + Nötr	275	40	1,5	252515	510,20
NU6-IIG/F T2 20kA 320V 3P	Tip 2	3 Kutup	275	40	1,5	252547	698,90
NU6-IIG/F T2 20kA 320V 3P+N	Tip 2	3 Kutup + Nötr	275	40	1,5	252563	1.083,00



Noark Ex9UE Alçak Gerilim Parafudrları

Tip 1 + 2 (Sayaç öncesi, ana dağıtım panosu)

Ürün Tanımı	Tip	Kutup Sayısı	Sürekli Çalışma Gerilimi Uc (V)	Imax (kA)	Sipariş Kodu	Birim Fiyat (₺)
Ex9UE1+2 12.5 275	Tip 1+2	1 Kutup	275	50	103332	632,60
Ex9UE1+2 12.5R 275	Tip 1+2	1 Kutup	275	50	103333	650,90
Ex9UE1+2 12.5 275	Tip 1+2	1 Kutup+Nötr	275	50	103334	1.234,00
Ex9UE1+2 12.5R 275	Tip 1+2	1 Kutup+Nötr	275	50	103335	1.286,00
Ex9UE1+2 12.5 275	Tip 1+2	2 Kutup	275	50	103336	1.286,00
Ex9UE1+2 12.5R 275	Tip 1+2	2 Kutup	275	50	103337	1.355,00
Ex9UE1+2 12.5 275	Tip 1+2	3 Kutup	275	50	103338	1.801,00
Ex9UE1+2 12.5R 275	Tip 1+2	3 Kutup	275	50	103339	1.937,00
Ex9UE1+2 12.5 275	Tip 1+2	3 Kutup+Nötr	275	50	103340	2.469,00
Ex9UE1+2 12.5R 275	Tip 1+2	3 Kutup+Nötr	275	50	103341	2.607,00
Ex9UE1+2 12.5 275	Tip 1+2	4 Kutup	275	50	103342	2.607,00
Ex9UE1+2 12.5R 275	Tip 1+2	4 Kutup	275	50	103343	2.829,00

Aksesuar

Ürün Tanımı	Sürekli Çalışma Gerilimi Uc (V)	Sipariş Kodu	Birim Fiyat (₺)
Ex9UE1+2 12.5 1P 275 M	275	103330	449,30
Ex9UE1+2 NPE M	N-PE	103331	449,30

* Ürün tanımında "R" ibaresi bulunan ürünlerde bir üstündeki üründen farklı olarak sinyal kontağı bulunmaktadır.



Noark Ex9UE Alçak Gerilim Parafudrları

Parafudr Tip 2 (Sayaç sonrası, tali pano)

Ürün Tanımı	Tip	Kutup Sayısı	Sürekli Çalışma Gerilimi Uc (V)	Imax (kA)	Sipariş Kodu	Birim Fiyat (₺)
Ex9UE2 20 275	Tip 2	1 Kutup	275	40	103347	290,40
Ex9UE2 20R 275	Tip 2	1 Kutup	275	40	103348	342,30
Ex9UE2 20 275	Tip 2	1 Kutup+Nötr	275	40	103349	632,60
Ex9UE2 20R 275	Tip 2	1 Kutup+Nötr	275	40	103350	684,40
Ex9UE2 20 275	Tip 2	2 Kutup	275	40	103351	632,60
Ex9UE2 20R 275	Tip 2	2 Kutup	275	40	103352	684,40
Ex9UE2 20 275	Tip 2	3 Kutup	275	40	103353	977,70
Ex9UE2 20R 275	Tip 2	3 Kutup	275	40	103354	1.030,00
Ex9UE2 20 275	Tip 2	3 Kutup+Nötr	275	40	103355	1.252,00
Ex9UE2 20R 275	Tip 2	3 Kutup+Nötr	275	40	103356	1.372,00
Ex9UE2 20 275	Tip 2	4 Kutup	275	40	103357	1.355,00
Ex9UE2 20R 275	Tip 2	4 Kutup	275	40	103358	1.490,00
Ex9UE2 20 320	Tip 2	1 Kutup	320	40	103754	308,30
Ex9UE2 20R 320	Tip 2	1 Kutup	320	40	103755	327,00
Ex9UE2 20 320	Tip 2	1 Kutup+Nötr	320	40	103756	640,60
Ex9UE2 20R 320	Tip 2	1 Kutup+Nötr	320	40	103757	688,90
Ex9UE2 20 320	Tip 2	2 Kutup	320	40	103758	640,60
Ex9UE2 20R 320	Tip 2	2 Kutup	320	40	103759	688,90
Ex9UE2 20 320	Tip 2	3 Kutup	320	40	103760	956,80
Ex9UE2 20R 320	Tip 2	3 Kutup	320	40	103761	1.102,00
Ex9UE2 20 320	Tip 2	3 Kutup+Nötr	320	40	103762	1.307,00
Ex9UE2 20R 320	Tip 2	3 Kutup+Nötr	320	40	103763	1.425,00
Ex9UE2 20 20	Tip 2	4 Kutup	320	40	103764	1.307,00
Ex9UE2 20R 320	Tip 2	4 Kutup	320	40	103765	1.425,00
Ex9UE2 20 385	Tip 2	1 Kutup	385	40	103766	418,70
Ex9UE2 20R 385	Tip 2	1 Kutup	385	40	103767	433,90
Ex9UE2 20 385	Tip 2	1 Kutup+Nötr	385	40	103768	886,10
Ex9UE2 20R 385	Tip 2	1 Kutup+Nötr	385	40	103769	986,90
Ex9UE2 20 385	Tip 2	2 Kutup	385	40	103770	886,10
Ex9UE2 20R 385	Tip 2	2 Kutup	385	40	103771	986,90
Ex9UE2 20 385	Tip 2	3 Kutup	385	40	103772	1.290,00
Ex9UE2 20R 385	Tip 2	3 Kutup	385	40	103773	1.394,00
Ex9UE2 20 385	Tip 2	3 Kutup+Nötr	385	40	103774	1.625,00
Ex9UE2 20R 385	Tip 2	3 Kutup+Nötr	385	40	103775	1.726,00
Ex9UE2 20 385	Tip 2	4 Kutup	385	40	103776	1.625,00
Ex9UE2 20R 385	Tip 2	4 Kutup	385	40	103777	1.726,00
Ex9UE2 20 440	Tip 2	1 Kutup	440	40	103359	418,70
Ex9UE2 20R 440	Tip 2	1 Kutup	440	40	103360	433,90
Ex9UE2 20 440	Tip 2	1 Kutup+Nötr	440	40	103361	886,10
Ex9UE2 20R 440	Tip 2	1 Kutup+Nötr	440	40	103362	986,90
Ex9UE2 20 440	Tip 2	2 Kutup	440	40	103363	886,10
Ex9UE2 20R 440	Tip 2	2 Kutup	440	40	103364	986,90
Ex9UE2 20 440	Tip 2	2 Kutup	440	40	103365	1.290,00
Ex9UE2 20R 440	Tip 2	3 Kutup	440	40	103366	1.394,00
Ex9UE2 20 440	Tip 2	3 Kutup+Nötr	440	40	103367	1.625,00
Ex9UE2 20R 440	Tip 2	3 Kutup+Nötr	440	40	103368	1.726,00
Ex9UE2 20 440	Tip 2	4 Kutup	440	40	103369	1.625,00
Ex9UE2 20R 440	Tip 2	4 Kutup	440	40	103370	1.726,00



Ürün Tanımı	Sürekli Çalışma Gerilimi Uc (V)	Sipariş Kodu	Birim Fiyat (₺)
Ex9UE2 20 1P 275 M	275	103344	418,70
Ex9UE2 20 1P 320 M	320	103752	433,90
Ex9UE2 20 1P 380 M	380	103753	886,10
Ex9UE2 20 1P 440 M	440	103345	986,90
Ex9UE2 40 NPE M	N-PE	103346	886,10

* Ürün tanımında "R" ibaresi bulunan ürünlerde bir üstündeki üründen farklı olarak sinyal kontağı bulunmaktadır.



Fotovoltaik NB1 Serisi 63 DC Sigorta

6 kA C | DC Kesme

	In (A)	Sipariş Kodu	Birim Fiyat (₺)	Kutu Adeti
250 V 6KA DC 1 Kutup 	1	182699	130,50	12
	2	182700	130,50	12
	3	182701	130,50	12
	4	182702	130,50	12
	6	182703	116,80	12
	10	182704	109,90	12
	16	182706	109,90	12
	20	182707	109,90	12
	25	182708	109,90	12
	32	182709	116,80	12
	40	182710	130,50	12
	50	182711	137,40	12
	63	182712	144,30	12
	500 V 6KA DC 2 Kutup 	1	182713	265,90
2		182714	265,90	6
3		182715	265,90	6
4		182716	265,90	6
6		182717	247,70	6
10		182718	226,20	6
13		182719	226,20	6
16		182720	226,20	6
20		182721	226,20	6
25		182722	226,20	6
32		182723	247,70	6
40		182724	278,20	6
50		182725	290,40	6
63		182726	314,80	6
1000 V 6KA DC 4 Kutup 	1	182727	620,30	3
	2	182728	620,30	3
	3	182729	620,30	3
	4	182730	620,30	3
	6	182731	501,10	3
	10	182732	452,30	3
	13	182733	452,30	3
	16	182734	452,30	3
	20	182735	452,30	3
	25	182736	452,30	3
	32	182737	501,10	3
	40	182738	620,30	3
	50	182739	650,90	3
	63	182740	702,70	3



1000 V DC Kartuş Sigorta



Kutup	Ürün Tanımı	Tip	Sipariş Kodu	Birim Fiyat (₺)
1	Sigorta Tutucu	Ex9FP 30A	101766	64,71
2	Sigorta Tutucu	Ex9FP 30A	101767	126,50

NJMC1 Darbe Akım Anahtarı

Ürün Tanımı	In (A)	V (AC)	V (DC)	Sipariş Kodu	Birim Fiyat (₺)	Kutu Adeti
1 Kutup	16	220		657012	181,30	12
	16		24	657011	213,00	12
	32	220		657014	264,50	12
	32		24	657013	264,50	12



Standart	IEC/EN 61810-1
Bobin Besleme Gerilimi	AC:220V ; DC:24V
Kontak Akımı	16/32A
Kutup	1 Kutuplu
Başlangıç Kontak Direnci	100m Ohm
Maksimum Anahtarlama	4000VA 448W (16A) 8000VA 896 W (32 A)
Operasyon Süresi	≤20ms
Puls Gerilim Süresi	≥50ms
Kirlilik Seviyesi	I
Aşırı Gerilim Kategorisi	II
Sıcaklık Aralığı	-25...+550C

NCH8 Serisi Bina İçi Aydınlatma/Otomasyon Kontaktörü

DIN Ray Tipi



Sessiz Kontaktör AC-1	In (A) 220/230 V AC 50/60 Hz	Yardımcı Kontakt	Sipariş Kodu	Birim Fiyat (₺)	Kutu Adeti
2 Kutup	20 A	2NA	256054	151,20	8
	20 A	1NA +1NK	256052	151,20	8
	20 A	2NK	256053	151,20	8
	40 A	2NA	256081	393,30	6
	40 A	1NA +1NK	256083	393,30	6
	63 A	2NA	256093	492,10	6



Sessiz Kontaktör AC-1	In (A) 220/230 V AC 50/60 Hz	Yardımcı Kontakt	Sipariş Kodu	Birim Fiyat (₺)	Kutu Adeti
4 Kutup	20 A	4NA	256085	189,30	6
	20 A	2NA +2NK	256087	189,30	6
	25 A	4NA	256089	242,40	6
	25 A	2NA +2NK	256091	242,40	6
	40 A	4NA	256099	425,80	4
	63 A	4NA	256101	376,20	4
	63 A	3NA +1NK	256217	518,20	6
	63 A	2NA +2NK	256219	518,20	6



NKG3 Dijital Zaman Saati

Astronomik



Ürün Tanımı 220 V AC 50/60 Hz	Sipariş Kodu	Birim Fiyat (₺)	Kutu Adeti
NKG3 8 ON veya 8 OFF Kontaklı	310024	534,60	1
Zaman Hassasiyeti	< 2 Saniye		
Zaman Rezervi	1 dakika-168 saat		
Mekanik Ömür	> 30.000		
Elektrik Ömür	>10.000		
Montaj Tip	Raya Montaj		
Gösterge	Dijital Ekran		

KG316T Dijital Zaman Saati

Enerjisiz Yazlık, Ofis ve Sokak Aydınlatmalarına Özel



Ürün Tanımı 220 V AC 50/60 Hz	Sipariş Kodu	Birim Fiyat (₺)	Kutu Adeti
KG316T 8 ON veya 8 OFF Kontaklı	309009	658,90	1
Mekanik Ömür	1 X 10 5		
Elektrik Ömür	1 X 10 6		
Montaj Tip	Raya Montaj		
Gösterge	Dijital Ekran		



NH4 Serisi Yük Ayırıcılar



	In (A) 230/400 V AC 50/60 Hz	Sipariş Kodu	Birim Fiyat (₺)
1 Kutup	32	398037	43,89
	63	398038	46,16
	100	398036	68,10
	125	398032	78,99
2 Kutup	32	398040	94,59
	63	398041	105,50
	100	398039	123,90
	125	398033	131,10
3 Kutup	32	398043	119,60
	63	398044	134,10
	100	398042	163,60
	125	398034	180,30
4 Kutup	32	398046	160,20
	63	398047	178,80
	100	398045	223,60
	125	398035	236,60



RT28N-32 Serisi Sigorta Yuvaları (gG/gL Hızlı Tip Sigorta)



	Ürün Tanımı 230/400 V AC 50/60 Hz	Sipariş Kodu	Birim Fiyat (₺)	Kutu Adeti
10 X 38 YUVALAR	1 Kutup	520484	28,32	12
	2 Kutup	520485	58,69	12
	3 Kutup	520486	82,90	12
gG/gL Silindirik Sigortalar 500 V AC	2A	520474	6,91	12
	4A	520475	6,91	12
	6A	520476	6,91	12
	10A	520478	6,91	10
	16A	520480	6,91	10
	20A	520481	6,91	10
	25A	520482	6,91	10
	32A	520483	7,17	10



NHR17 Serisi Yatay Yük Ayırıcıları

Yatay | AC Sınıfı



	Ürün Tanımı	Uygun Sigorta	Sipariş Kodu	Birim Fiyat (₺)
3 Kutup (Sigortasız)	100 A	Boy 00 Sigorta	403021	530,00
	160 A	Boy 00 ve Boy 0 Sigorta	403022	560,00
	250 A	80, 100, 125, 160, 200, 250	403023	1.000,00
	400 A	125, 160, 200, 250, 300, 315, 355, 400	403024	1.700,00
	630 A	315, 355, 400, 425, 500, 600	403025	1.984,00

NHRT40 Dikey Yük Ayırıcı

3 Faz



	Ürün Tanımı	Sipariş Kodu	Birim Fiyat (₺)
Birlikte Ayırma	NHRT41-160/3L	842051	1.211,00
	NHRT41-250/3L	842052	2.352,00
	NHRT41-400/3L	842053	2.756,00
	NHRT41-630/3L	842054	3.279,00
Bağımsız Ayırma	NHRT41-160/3	842047	1.211,00
	NHRT41-250/3	842048	2.352,00
	NHRT41-400/3	842049	2.756,00
	NHRT41-630/3	842050	3.279,00



NH40 Serisi Yük Ayırıcıları

Yatay | AC/DC Sınıfı

3150A'e kadar sigortasız ayırıcı !



	Ürün Tanımı 400 V	Sipariş Kodu	Birim Fiyat (₺)
3 Kutup	125A	393261	1.027,00
	250A	393264	1.598,00
	400A	393266	2.477,00
	630A	393267	3.212,00
	1000 A	393268	5.298,00
	1250A	393269	5.332,00
	1600 A	393270	6.032,00
	2000 A	393271	17.000,00
	2500 A	393272	19.370,00
	3150 A	393273	21.000,00
		NH40 Serisi için Yardımcı Kontak 1NA+1 NK	NH40-AU
	NH40 Serisi Metal Çubuk+Pano üstü Kol 630 a kadar	NH40-EXH1	1.183,00
	NH40 Serisi Metal Çubuk+Pano üstü Kol 1000-3150 a kadar	NH40-EXH2	1.801,00

NXZ Serisi Otomatik Transfer Şalterleri



Ürün Tanımı	Nominal Akım In (A)	Kutup sayısı	Kısa Devre Kesme Kapasitesi Icu (kA)	Sipariş Kodu	Birim Fiyat (₺)
NXZM-63S/3B	10	3	25	256763	5.603,00
NXZM-63S/3B	16	3	25	256762	5.649,00
NXZM-63S/3B	25	3	25	256761	5.694,00
NXZM-63S/3B	32	3	25	256760	5.831,00
NXZM-63S/3B	40	3	25	256759	5.900,00
NXZM-63S/3B	50	3	25	256758	5.957,00
NXZM-63S/3B	63	3	25	256757	6.058,00
NXZM-125S/3B	80	3	25	256778	6.918,00
NXZM-125S/3B	100	3	25	256781	7.210,00
NXZM-125S/3B	125	3	25	256780	7.946,00
NXZM-160S/3B	160	3	35	256790	8.129,00
NXZM-250S/3B	180	3	35	256799	8.259,00
NXZM-250S/3B	200	3	35	256798	9.866,00
NXZM-250S/3B	225	3	35	256797	9.941,00
NXZM-250S/3B	250	3	35	256796	12.577,00
NXZM-400S/3B	315	3	50	256813	13.491,00
NXZM-400S/3B	350	3	50	256812	14.040,00
NXZM-400S/3B	400	3	50	256811	14.950,00
NXZM-630S/3B	500	3	50	256824	15.778,00
NXZM-630S/3B	630	3	50	256823	16.953,00
NXZM-800S/3B	700	3	50	256833	19.269,00
NXZM-800S/3B	800	3	50	256832	19.969,00
NXZM-63S/4B	10	4	25	256777	5.831,00
NXZM-63S/4B	16	4	25	256776	5.900,00
NXZM-63S/4B	25	4	25	256775	5.957,00
NXZM-63S/4B	32	4	25	256774	6.026,00
NXZM-63S/4B	40	4	25	256773	6.129,00
NXZM-63S/4B	50	4	25	256772	6.208,00
NXZM-63S/4B	63	4	25	256771	6.367,00
NXZM-125S/4B	80	4	25	256786	7.432,00
NXZM-125S/4B	100	4	25	256789	7.743,00
NXZM-125S/4B	125	4	25	256788	8.266,00
NXZM-160S/4B	160	4	35	256794	8.519,00
NXZM-250S/4B	180	4	35	256809	8.735,00
NXZM-250S/4B	200	4	35	256808	9.033,00
NXZM-250S/4B	225	4	35	256807	9.227,00
NXZM-250S/4B	250	4	35	256806	9.464,00
NXZM-400S/4B	315	4	50	256821	14.863,00
NXZM-400S/4B	350	4	50	256820	16.350,00
NXZM-400S/4B	400	4	50	256819	17.728,00
NXZM-630S/4B	500	4	50	256830	18.408,00
NXZM-630S/4B	630	4	50	256829	19.123,00
NXZM-800S/4B	700	4	50	256839	21.022,00
NXZM-800S/4B	800	4	50	256838	21.722,00

Kompakt Tip Devre Kesiciler



CHNT

NXM Serisi Devre Kesiciler

Sabit | Termik Manyetik | 3 Kutuplu

Nominal Akım In (A)	Ürün Tanımı	Kesme Kapasitesi Icu(kA)	Sipariş Kodu	Birim Fiyat (₺)	Ürün Tanımı	Kesme Kapasitesi Icu(kA)	Sipariş Kodu	Birim Fiyat (₺)
10	G NXM-63S/3300	25	205882	569,90	G NXM-63H/3300	50	205890	609,70
16	G NXM-63S/3300	25	205883	569,90	G NXM-63H/3300	50	205891	609,70
20	G NXM-63S/330	25	205884	569,90	G NXM-63H/3300	50	205892	609,70
25	G NXM-63S/3300	25	205885	569,90	G NXM-63H/3300	50	205893	609,70
32	G NXM-63S/3300	25	205886	569,90	G NXM-63H/3300	50	205894	609,70
40	G NXM-63S/3300	25	205887	569,90	G NXM-63H/3300	50	205895	609,70
50	G NXM-63S/3300	25	205888	569,90	G NXM-63H/3300	50	205896	609,70
63	G NXM-63S/3300	25	205889	569,90	G NXM-63H/3300	50	205897	609,70
80	G NXM-125S/3300	25	131361	663,80	G NXM-125H/3300	50	844290	710,30
100	G NXM-125S/3300	25	131362	685,10	G NXM-125H/3300	50	844283	733,00
125	G NXM-125S/3300	25	131363	727,40	G NXM-125H/3300	50	844284	778,30
160	G NXM-160S/3300	36	131364	889,50	G NXM-160H/3300	50	844323	951,60
200	G NXM-250S/3300	36	131367	1.099,00	G NXM-250H/3300	50	844331	1.175,00
225	G NXM-250S/3300	36	131368	1.187,00	G NXM-250H/3300	50	844332	1.272,00
250	G NXM-250S/3300	36	131369	1.212,00	G NXM-250H/3300	50	844333	1.298,00
315	G NXM-400S/3300	36	131371	2.513,00	G NXM-400H/3300	50	844355	2.687,00
400	G NXM-400S/3300	36	131373	2.782,00	G NXM-400H/3300	50	844358	2.977,00
500	G NXM-630S/3300	50	131374	3.433,00	G NXM-630H/3300	70	844369	3.675,00
630	G NXM-630S/3300	50	131375	3.585,00	G NXM-630H/3300	70	844370	3.835,00
800	G NXM-800S/3300	50	131376	8.384,00	G NXM-800H/3300	70	844379	8.971,00
1000	G NXM-1000S/3300	50	131377	9.783,00	G NXM-1000H/3300	70	844276	10.467,00
1250	G NXM-1250S/3300T	50	218740	13.553,00	G NXM-1250H/3300T	70	218742	14.502,00
1600	G NXM-1600S/3300T	50	131378	16.070,00	G NXM-1600H/3300T	70	844313	17.195,00



Sabit | Termik Manyetik | 4 Kutuplu

Nominal Akım In (A)	Ürün Tanımı	Kesme Kapasitesi Icu(kA)	Sipariş Kodu	Birim Fiyat (₺)	Ürün Tanımı	Kesme Kapasitesi Icu(kA)	Sipariş Kodu	Birim Fiyat (₺)
10	G NXM-63S/4300B	25	205906	922,40	G NXM-63H/4300B	50	205898	986,90
16	G NXM-63S/4300B	25	205907	922,40	G NXM-63H/4300B	50	205899	986,90
20	G NXM-63S/4300B	25	205908	922,40	G NXM-63H/4300B	50	205900	986,90
25	G NXM-63S/4300B	25	205909	922,40	G NXM-63H/4300B	50	205901	986,90
32	G NXM-63S/4300B	25	205910	922,40	G NXM-63H/4300B	50	205902	986,90
40	G NXM-63S/4300B	25	205911	922,40	G NXM-63H/4300B	50	205903	986,90
50	G NXM-63S/4300B	25	205912	922,40	G NXM-63H/4300B	50	205904	986,90
63	G NXM-63S/4300B	25	205913	922,40	G NXM-63H/4300B	50	205905	986,90
80	G NXM-125S/4300B	25	844310	998,50	G NXM-125H/4300B	50	844298	1.069,00
100	G NXM-125S/4300B	25	844303	1.035,00	G NXM-125H/4300B	50	844291	1.108,00
125	G NXM-125S/4300B	25	844304	1.078,00	G NXM-125H/4300B	50	844292	1.153,00
160	G NXM-160S/4300B	20	844328	1.245,00	G NXM-160H/4300B	50	844325	1.333,00
180	G NXM-250S/4300B	36	844340	1.356,00	G NXM-250H/4300B	50	844335	1.451,00
200	G NXM-250S/4300B	36	844341	1.405,00	G NXM-250H/4300B	50	844336	1.503,00
225	G NXM-250S/4300B	36	844342	1.503,00	G NXM-250H/4300B	50	844337	1.610,00
250	G NXM-250S/4300B	36	844343	1.591,00	G NXM-250H/4300B	50	844338	1.703,00
315	G NXM-400S/4300B	36	844364	3.669,00	G NXM-400H/4300B	50	844359	3.927,00
350	G NXM-400S/4300B	36	844366	3.620,00	G NXM-400H/4300B	50	844361	3.873,00
400	G NXM-400S/4300B	36	844367	3.963,00	G NXM-400H/4300B	50	844362	4.239,00
500	G NXM-630S/4300B	50	844376	5.939,00	G NXM-630H/4300B	70	844372	6.355,00
630	G NXM-630S/4300B	50	844377	6.366,00	G NXM-630H/4300B	70	844373	6.813,00
800	G NXM-800S/4300B	50	844384	8.734,00	G NXM-800H/4300B	70	844381	9.346,00
1000	G NXM-1000S/4300B	50	844281	10.131,00	G NXM-1000H/4300B	70	844278	10.841,00
1250	G NXM-1600S/4300TB	50	844320	19.214,00	G NXM-1600H/4300TB	70	844315	20.559,00
1600	G NXM-1600S/4300TB	50	844321	20.611,00	G NXM-1600H/4300TB	70	844316	22.054,00









⚠️ **Önemli Not:** NXM serisi ürünler alttan giriş, üstten çıkış olacak şekilde montaja uygun değildir. Alttan giriş üstten çıkış bağlantı yapılması üründe hasara sebep olabilir.



NXM Serisi Devre Kesiciler

Aksesuarlar

	Ürün Tanımı	Besleme Gerilimi	Sipariş Kodu	Birim Fiyat (₺)
	NXM-63/125 Sağ		946951	170,60
	NXM-160 Sol		946946	170,60
	NXM-160 Sağ		946949	170,60
	NXM-250/320 Sol		946944	192,90
	NXM-250/320 Sağ		946943	192,90
	NXM- 400/630 Sol		946941	457,10
	NXM- 800 Sol		946938	520,00
	NXM- 800 Sağ		946935	520,00
	NXM- 1600 Sol		146145	629,00
	NXM-63/125 Sol	AC 230V	203834	497,50
	NXM-160 Sol	AC 230V	152863	497,50
	NXM-250/320 Sağ	AC 230V	152865	532,50
	NXM- 400/630 Sağ	AC 230V	946968	978,40
	NXM- 800 Sol	AC 230V	946978	1.107,00
	NXM- 1000 Sol	AC 230V	946985	1.210,00
	NXM- 1600 Sol	AC 230V	946960	2.447,00
	NXM-63/125 Sol	AC 230V	946996	388,60
	NXM-63/125 Sağ	AC 230V	946958	388,60
	NXM-160 Sol	AC 230V	946953	388,60
	NXM-160 Sağ	AC 230V	946974	388,60
	NXM-250/320 Sol	AC 230V	946972	479,50
	NXM-250/320 Sağ	AC 230V	946969	479,50
	NXM- 400/630 Sağ	AC 230V	946966	890,30
	NXM- 800 Sağ	AC 230V	946981	1.033,00
	NXM- 1000 Sağ	AC 230V	946988	1.102,00
	NXM- 1600 Sol	AC 230V	946961	1.327,00
	NXM-63/125 Sağ		201842	124,40
	NXM-160 Sol		946947	124,40
	NXM-160 Sağ		946950	124,40
	NXM-250/320 Sol		203836	124,40
	NXM- 400/630 Sol		946939	279,60
	NXM- 800 Sol		946937	293,70
	NXM- 800 Sağ		946934	293,70
	NXM- 1600 Sağ		146146	293,70
		NXM-63/125	AC/DC 230V	946922
NXM-160S		AC/DC 230V	946905	3.299,00
NXM-160H		AC/DC 230V	946904	3.299,00
NXM-250/320		AC/DC 230V	946926	3.493,00
NXM- 400/630		AC/DC 230V	946912	6.289,00
NXM- 800		AC/DC 230V	946908	6.988,00
NXM- 1000		AC/DC 230V	946916	8.384,00
NXM- 1600		AC/DC 230V	946914	9.083,00
		NXM-63/125		946896
	NXM-160		946886	510,20
	NXM-250/320		946889	510,20
	NXM- 400/630		946891	629,00
	NXM- 800		946887	698,90
	NXM- 1000		946894	768,60
	NXM- 1600		946892	978,40

* Kutup belirtilmeyen ürünler 3 ve 4 kutup için uygundur.

* Kesme kapasitesi modeli belirtilmeyen ürünler S ve H modelleri için uygundur.

NM8 Alçak Gerilim Devre Kesiciler

Ayarlı | Termik Manyetik | 3 Kutuplu



Ürün Tanımı	Kısa Devre Kesme Kapasitesi Icu (kA)	Kesme Ics (kA)	Termik Ayar Sahası (A)	Manyetik Ayar Sahası (A)	Sipariş Kodu	Birim Fiyat (₺)
NM8-125S 3 Kutup 16A T.M.Ş.	50	50	14-16	80-160	149678	946,60
NM8-125S 3 Kutup 20A T.M.Ş.	50	50	16-20	100-200	149679	946,60
NM8-125S 3 Kutup 25A T.M.Ş.	50	50	20-25	125-250	149680	943,40
NM8-125S 3 Kutup 32A T.M.Ş.	50	50	25-32	160-320	149681	943,40
NM8-125S 3 Kutup 40A T.M.Ş.	50	50	32-40	200-400	149682	943,40
NM8-125S 3 Kutup 50A T.M.Ş.	50	50	40-50	250-500	149683	943,40
NM8-125S 3 Kutup 63A T.M.Ş.	50	50	50-63	320-630	149684	943,40
NM8-125S 3 Kutup 80A T.M.Ş.	50	50	64-80	400-800	149685	943,40
NM8-125S 3 Kutup 100A T.M.Ş.	50	50	80-100	500-1000	149358	963,80
NM8-125S 3 Kutup 125A T.M.Ş.	50	50	100-125	620-1250	149676	1.150,00
NM8-250S 3 Kutup 160A T.M.Ş.	50	50	128-160	800-1600	149477	1.180,00
NM8-250S 3 Kutup 200A T.M.Ş.	50	50	160-200	1000-2000	149478	1.484,00
NM8-250S 3 Kutup 250A T.M.Ş.	50	50	200-250	1250-2500	149479	1.513,00
NM8-400S 3 Kutup 315A T.M.Ş.	70	70	252-315	1565-3150	149725	3.685,00
NM8-400S 3 Kutup 400A T.M.Ş.	70	70	320-400	2000-4000	149726	4.161,00
NM8-630S 3 Kutup 500A T.M.Ş.	70	70	400-500	2500-5000	149486	4.999,00
NM8S-630S 3 Kutup 630A T.M.Ş.	70	70	252-630	945-7560	149490	6.356,00
NM8-800S 3 Kutup 800A T.M.Ş.	50	25	640-800	4000-8000	149916	9.584,00
NM8-1250S 3 Kutup 1000A T.M.Ş.	50	25	800-1000	5000-10000	149858	13.403,00
NM8-1250S 3 Kutup 1250A T.M.Ş.	50	25	1000-1250	6250-12500	149856	16.573,00
NM8S-1600S 3kutup 1600A Elk. Açt. Ünt. T.M.Ş.	50	25	640-1600	2400-19200	150495	23.749,00



Ayarlı | Termik Manyetik | 4 Kutuplu



Ürün Tanımı	Kısa Devre Kesme Kapasitesi Icu (kA)	Kesme Ics (kA)	Termik Ayar Sahası (A)	Manyetik Ayar Sahası (A)	Sipariş Kodu	Birim Fiyat (₺)
NM8-125S 4 Kutup 32A T.M.Ş.	50	50	25-32	160-320	149934	1.525,00
NM8-125S 4 Kutup 40A T.M.Ş.	50	50	32-40	200-400	149935	1.525,00
NM8-125S 4 Kutup 50A T.M.Ş.	50	50	40-50	250-500	149936	1.525,00
NM8-125S 4 Kutup 63A T.M.Ş.	50	50	50-63	315-630	149937	1.525,00
NM8-125S 4 Kutup 80A T.M.Ş.	50	50	64-80	400-800	149938	1.665,00
NM8-125S 4 Kutup 100A T.M.Ş.	50	50	80-100	500-1000	149939	1.665,00
NM8-125S 4 Kutup 125A T.M.Ş.	50	50	100-125	625-1250	149940	1.889,00
NM8-250S 4 Kutup 160A T.M.Ş.	50	50	128-160	800-1600	149942	2.341,00
NM8-250S 4 Kutup 200A T.M.Ş.	50	50	160-200	1000-2000	149943	2.591,00
NM8-250S 4 Kutup 250A T.M.Ş.	50	50	200-250	1250-2500	149944	2.772,00
NM8-400S 4 Kutup 315A T.M.Ş.	70	70	252-315	1575-3150	149960	5.675,00
NM8-400S 4 Kutup 400A T.M.Ş.	70	70	320-400	2000-4000	149962	6.042,00
NM8-630S 4 Kutup 500A T.M.Ş.	70	70	400-500	2500-5000	149964	6.616,00
NM8-800S 4 Kutup 630A T.M.Ş.	50	50	504-630	3780-7560	149994	12.680,00
NM8-800S 4 Kutup 800A T.M.Ş.	50	50	640-800	4000-8000	149995	16.043,00
NM8-1250S 4 Kutup 1000A T.M.Ş.	50	50	800-1000	5000-10000	149996	24.245,00
NM8-1250S 4 Kutup 1250A T.M.Ş.	50	50	800 - 1250	6125-12500	150000	24.997,00



NM8 Serisi Alçak Gerilim Devre Kesiciler

Ayarlı | Termik Manyetik Yüksek Kesme Kapasitesi 100kA | 3 Kutup



Ürün Tanımı	Kısa Devre Kesme Kapasitesi		Termik Ayar Sahası (A)	Manyetik Ayar Sahası (A)	Sipariş Kodu	Birim Fiyat (₺)
	Icu (kA)	Ics (kA)				
NM8-125H 3 Kutup 40A	100	100	32-40	200-400	149690	1.340,00
NM8-125H 3 Kutup 50A	100	100	40-50	250-500	149691	1.340,00
NM8-125H 3 Kutup 63A	100	100	50-63	320-630	149692	1.340,00
NM8-125H 3 Kutup 80A	100	100	64-80	400-800	149693	1.340,00
NM8-125H 3 Kutup 100A	100	100	80-100	500-1000	149694	1.340,00
NM8-125H 3 Kutup 125A	100	100	100-125	620-1250	149695	1.438,00
NM8-250H 3 Kutup 160A	100	100	128-160	800-1600	149470	1.846,00
NM8-250H 3 Kutup 200A	100	100	160-200	1000-2000	149471	2.498,00
NM8-250H 3 Kutup 250A	100	100	200-250	1250-2500	149472	2.616,00











Sadece Manyetik Korumalı Devre Kesiciler | 3 Kutup



Ürün Tanımı	Kısa Devre Kesme Kapasitesi		Manyetik Ayar Sahası (A)	Sipariş Kodu	Birim Fiyat (₺)
	Icu (kA)	Ics (kA)			
NM8-125S 3 kutup 32A 50kA	50	50	160-320	149410	1.438,00
NM8-125S 3 kutup 40A 50kA	50	50	200-400	149407	1.438,00
NM8-125S 3 kutup 50A 50kA	50	50	250-500	149409	1.438,00
NM8-125S 3 kutup 80A 50kA	50	50	400-800	149406	1.438,00
NM8-125S 3 kutup 100A 50kA	50	50	500-1000	149405	1.438,00
NM8-125S 3 kutup 125A 50kA	50	50	525-1250	149404	2.195,00
NM8-250S 3 kutup 160A 50kA	50	50	800-1600	149416	2.195,00
NM8-250S 3 kutup 200A 50kA	50	50	1000-2000	149415	2.195,00
NM8-250S 3 kutup 250A 50kA	50	50	1250-2500	149414	2.195,00

NM8 Serisi Kompakt Tip Devre Kesiciler

Aksesuarlar

	Ürün Tanımı	Besleme Gerilimi	Sipariş Kodu	Birim Fiyat (₺)		
Mekanik Kilit 	NM8-125 3P		150790	317,90		
	NM8-125 4P		150792	317,90		
	NM8-250 3P	NM8S-125, 250 3P	150794	317,90		
	NM8-250 4P	NM8S-125, 250 4P	150795	317,90		
	NM8-400, 630 3P	NM8S-400, 630 3P	150796	537,40		
	NM8-400, 630 4P	NM8S-400, 630 4P	150797	537,40		
Sabit Tip Şalteri Soketli Tipe Dönüştürme Aksesuarları - Soket Sabit Parça 	NM8-250 3P	NM8S-125, 250 3P	150760	1.883,00		
	NM8-125 3P		150761	1.608,00		
	NM8-125 4P		150875	1.608,00		
	NM8-250 4P	NM8S-125, 250 4P	150876	2.772,00		
	NM8-400, 630 4P	NM8S-400, 630 4P	150878	6.691,00		
	NM8-400, 630 3P	NM8S-400, 630 3P	150892	5.550,00		
Din Rayı Bağlantı Aparatı 	NM8-125 3P		150763	81,72		
	NM8-250 3P	NM8S-125, 250 3P	150765	90,80		
	NM8-250 4P	NM8S-125, 250 4P	150766	94,43		
	NM8-125 4P		150767	99,88		
Açtırma Bobini 	NM8-125		220V AC	150848	552,50	
	NM8-250, 400, 630	NM8S-125, 250, 400, 630	220V AC	150747	567,70	
	NM8-800, 1250, 1600	NM8S-800, 1250, 1600	220V AC	150851	1.301,00	
	NM8-125		380V AC	150849	567,70	
	NM8-250, 400, 630	NM8S-125, 250, 400, 630	380V AC	150746	567,70	
	NM8-800, 1250, 1600	NM8S-800, 1250, 1600	380V AC	150853	1.301,00	
	NM8-125		24V DC	150847	977,70	
	NM8-250,400,630	NM8S-125, 250, 400, 630	24V DC	150748	996,10	
	NM8-800, 1250, 1600	NM8S-800, 1250, 1600	24V DC	150753	1.557,00	
	Düşük Gerilim Bobini 	NM8-125		220V AC	150850	605,50
NM8-250, 400, 630		NM8S-125, 250, 400, 630	220V AC	150750	605,50	
NM8-800, 1250, 1600		NM8S-800, 1250, 1600	220V AC	150855	1.082,00	
NM8-125			380V AC	150846	620,60	
NM8-250, 400, 630		NM8S-125, 250, 400, 630	380V AC	150749	620,60	
NM8-800, 1250, 1600		NM8S-800, 1250, 1600	380V AC	150856	908,20	
NM8-250, 400, 630		NM8S-125, 250, 400, 630	24V DC	900330	907,50	
NM8-800, 1250, 1600		NM8S-800, 1250, 1600	24V DC	900333	1.082,00	
Alarm/ Yardımcı Kontakt 		Yardımcı kontakt: Tüm NM8 serileri	Yardımcı kontakt: Tüm NM8S serileri		150869	186,20
		Alarm kontakt: NM8 -125, 250, 400, 630	Alarm kontakt: NM8S -125, 250, 400, 630		150870	218,20
	Alarm kontakt: NM8 -800, 1250	Alarm kontakt: NM8S-800, 1250		900309	317,90	
Motor 	NM8-125		220V AC/DC	150881	3.096,00	
	NM8-250	NM8S-125,250	220V AC/DC	150882	3.096,00	
	NM8-400, 630	NM8S-400, 630	220V AC/DC	150884	7.116,00	
	NM8-800, 1250, 1600	NM8S-800, 1250, 1600	220V AC/DC	150890	7.338,00	
Direkt Döner Kurma Kolu 	NM8-125			150902	340,70	
	NM8-250			150903	340,70	
	NM8-400, 630			150900	514,60	
		NM8S-125, 250		150758	340,70	
		NM8S-400, 630		150898	408,70	
Milli Uzatılmış Döner Kurma Kolu Mekanizması 	NM8-125			150905	681,30	
	NM8-250			150896	681,30	
	NM8-400, 630			150909	718,90	
		NM8S-125, 250		150759	492,10	
		NM8S-400,630		150907	650,90	
Ekonomik Seri, Milli Uzatılmış Döner Kurma Kolu Mekanizması 	NM8-125 3P			150773	476,80	
	NM8-250 3P	NM8S-125, 250 3P		150775	476,80	
	NM8-400, 630 3P/4P	NM8S-400, 630 3P/4P		150777	635,70	
	NM8-800, 1250 3P/4P	NM8S-800, 1250 3P/4P		150910	1.286,00	
		NM8S-125 4P		150912	552,50	
	NM8-250 4P	NM8S-125, 250 4P		150913	552,50	
Kilitleme Aksesuarı 	NM8-125 Asma Kilit			150839	96,11	
	NM8-250 Asma Kilit	NM8S-125, 250 Asma Kilit		150840	103,00	
	NM8-400, 630 Asma Kilit	NM8S-400, 630 Asma Kilit		150842	103,00	
	NM8-1250 Asma Kilit	NM8S-1250 Asma Kilit		150844	109,90	

* Kutup sayısı belirtilmeyen aksesuarlar; ilgili ürünün tüm kutupları için kullanılmaktadır.

* Aksesuar seçimi için ürünün nominal akım değerini değil, kasa boyutunu dikkate alınız.

Kaçak Akım Algılamalı (Yangın Koruma) Kompakt Tip Devre Kesiciler

4 Kutup | Dahili Açtırma Bobinli



Ürün Tanımı	Kesme Kap. Icu (kA)	Kaçak Akım Ayar Sahası (mA)	Gecikme Süresi (s)	Sipariş Kodu	Birim Fiyat (₺)
NXMLE-125H/4310 Y D 25A	36	200-300-500	0.3-0.4-0.5	948589	1.525,00
NXMLE-125H/4310 Y D 32A	36	200-300-500	0.3-0.4-0.5	948590	1.534,00
NXMLE-125H/4310 Y D 40A	36	200-300-500	0.3-0.4-0.5	948591	1.593,00
NXMLE-125H/4310 Y D 50A	36	200-300-500	0.3-0.4-0.5	948592	1.600,00
NXMLE-125H/4310 Y D 63A	36	200-300-500	0.3-0.4-0.5	948593	1.610,00
NXMLE-125H/4310 Y D 80A	36	200-300-500	0.3-0.4-0.5	948594	1.619,00
NXMLE-125H/4310 Y D 100A	36	200-300-500	0.3-0.4-0.5	948587	1.627,00
NXMLE-125H/4310 Y D 125A	36	200-300-500	0.3-0.4-0.5	948588	1.842,00
NXMLE-160S/4310 Y D 160A	35	200-300-500	0.3-0.4-0.5	948619	1.949,00
NXMLE-250S/4310 Y D 180A	35	200-300-500	0.3-0.4-0.5	948637	2.160,00
NXMLE-250S/4310 Y D 200A	35	200-300-500	0.3-0.4-0.5	948638	2.414,00
NXMLE-250S/4310 Y D 225A	35	200-300-500	0.3-0.4-0.5	948639	2.499,00
NXMLE-250S/4310 Y D 250A	35	200-300-500	0.3-0.4-0.5	948640	2.540,00
NXMLE-400S/4310 Y D 315A	50	200-300-500	0.3-0.4-0.5	948662	4.657,00
NXMLE-400S/4310 Y D 350A	50	200-300-500	0.3-0.4-0.5	948663	4.871,00
NXMLE-400S/4310 Y D 400A	50	200-300-500	0.3-0.4-0.5	948664	4.912,00
NXMLE-630S/4310 Y D 500A	50	200-300-500	0.3-0.4-0.5	948675	6.563,00
NXMLE-630S/4310 Y D 630A	50	200-300-500	0.3-0.4-0.5	948676	6.627,00

⚠️ Önemli Not: NXMLE serisi ürünler alttan giriş, üstten çıkış olacak şekilde montaja uygun değildir. Alttan giriş üstten çıkış bağlantı yapılması üründe hasara sebep olabilir.

*Gecikmesiz tip ve farkı kaçak akım ayar sahaları ürünler için sorunuz.

NM8L Kaçak Korumalı 4 Kutuplu Kompakt Şalter

Kaçak Akım Korumalı Şalter



	Termik Manyetik Açtırma Üniteli 50 – 500mA	Kesme Kapasitesi Icu (kA)	Termik I (A)	Sipariş Kodu	Birim Fiyat (₺)
NM8L -125S	25/4	50	20-25	169231	3.466,00
	32/4	50	26-32	169232	3.466,00
	40/4	50	33-40	169233	3.466,00
	50/4	50	40-50	169234	3.466,00
	63/4	50	51-63	169235	3.466,00
	80/4	50	64-80	169243	3.466,00
	100/4	50	81-100	169244	3.466,00
	125/4	50	101-125	150041	3.466,00
NM8L -250S	160/4	50	126-160	169299	4.361,00
	200/4	50	161-200	169300	4.623,00
	250/4	50	201-250	169301	4.713,00

Açık Tip Devre Kesiciler



CHNT

NA1-X Serisi (LSI Koruma)

Ayarlı | Elektronik



3 Kutup Sabit Tip

Ürün Tanımı	Kesme Kap. Icu (kA)	Ics (kA)	Termik Ayar Sahası Ir(A)	Sipariş Kodu	Birim Fiyat (₺)
3 Kutup Sabit Tip NA1-2000XH 630A, 65kA	65	65	0,4-1*In	937394	18.161,00
3 Kutup Sabit Tip NA1-2000XH 800A, 65kA	65	65	0,4-1*In	937414	18.918,00
3 Kutup Sabit Tip NA1-2000XH 1000A, 65kA	65	65	0,4-1*In	937314	19.370,00
3 Kutup Sabit Tip NA1-2000XH 1250A, 65kA	65	65	0,4-1*In	937334	21.026,00
3 Kutup Sabit Tip NA1-2000XH 1600A, 65kA	65	65	0,4-1*In	937354	23.120,00
3 Kutup Sabit Tip NA1-2000XH 2000A, 65kA	65	65	0,4-1*In	937374	27.241,00
3 Kutup Sabit Tip NA1-3200XN 2500A, 65kA	65	65	0,4-1*In	937558	34.807,00
3 Kutup Sabit Tip NA1-3200XN 3200A, 65kA	65	65	0,4-1*In	937579	40.860,00
3 Kutup Sabit Tip NA1-4000X 4000A, 80kA	80	65	0,4-1*In	101164	68.100,00

*3 Kutup Sabit Tip 4000A ürünün Icu/Ics=%100 seçeneği için sorunuz.



4 Kutup Sabit Tip

Ürün Tanımı	Kesme Kap. Icu (kA)	Ics (kA)	Termik Ayar Sahası Ir(A)	Sipariş Kodu	Birim Fiyat (₺)
4 Kutup Sabit Tip NA1-2000XH 1000A, 65kA	65	65	0,4-1*In	937324	28.752,00
4 Kutup Sabit Tip NA1-2000XH 1250A, 65kA	65	65	0,4-1*In	937344	30.266,00
4 Kutup Sabit Tip NA1-2000XH 1600A, 65kA	65	65	0,4-1*In	937364	32.537,00
4 Kutup Sabit Tip NA1-2000XH 2000A, 65kA	65	65	0,4-1*In	937384	34.051,00
4 Kutup Sabit Tip NA1-3200XH 2500A, 65kA	65	65	0,4-1*In	937566	43.886,00
4 Kutup Sabit Tip NA1-3200XN 3200A, 65kA	65	65	0,4-1*In	937587	51.453,00

4 Kutup Çekmeceli Tip

Ürün Tanımı	Kesme Kap. Icu (kA)	Ics (kA)	Termik Ayar Sahası Ir(A)	Sipariş Kodu	Birim Fiyat (₺)
4 Kutup Çekmeceli Tip NA1-6300XN - 4000A, 100kA	100	100	0,4-1*In	937595	84.747,00

3 Kutup Çekmeceli Tip

Ürün Tanımı	Kesme Kap. Icu (kA)	Ics (kA)	Termik Ayar Sahası Ir(A)	Sipariş Kodu	Birim Fiyat (₺)
3 Kutup Çekmeceli NA 1-2000XH 630A, 65kA	65	65	0,4-1*In	937392	22.700,00
3 Kutup Çekmeceli NA 1-2000XH 800A, 65kA	65	65	0,4-1*In	937412	22.700,00
3 Kutup Çekmeceli NA 1-2000XH 1000A, 65kA	65	65	0,4-1*In	937312	23.079,00
3 Kutup Çekmeceli NA 1-2000XH 1250A, 65kA	65	65	0,4-1*In	937332	23.640,00
3 Kutup Çekmeceli NA 1-2000XH 1600A, 65kA	65	65	0,4-1*In	937352	27.669,00
3 Kutup Çekmeceli NA 1-2000XH 2000A, 65kA	65	65	0,4-1*In	937372	33.096,00
3 Kutup Çekmeceli NA 1-3200XN 2500A, 65kA	65	65	0,4-1*In	937556	42.378,00
3 Kutup Çekmeceli NA 1-3200XN 3200A, 65kA	65	65	0,4-1*In	937577	48.156,00
3 Kutup Çekmeceli NA 1-6300XN 4000A, 100kA	100	100	0,4-1*In	937591	68.100,00
3 Kutup Çekmeceli NA 1-6300XN 5000A, 100kA	100	100	0,4-1*In	937599	136.199,00



Aksesuarlar



Ürün Tanımı	Tipi	Sipariş Kodu	Birim Fiyat (₺)
Motor mekanizması 630A-2000A	220 V AC	102944	3.376,00
Motor 2500-5000 A	220 V AC	102950	3.764,00
Açtırma Bobini 630A-3200A NA-1	220 V AC	102840	1.059,00
Kapama Bobini 630A-3200A NA-1	220 V AC	102833	1.059,00
Düşük Gerilim Bobini NA-1	220 V AC	102851	1.059,00
Düşük Gerilim Bobini autonom tip		102848	1.300,00
Gecikmeli Düşük Gerilim Bobini AC220V NA-1	1-7 Saniye	102857	1.363,00
NA1 asma kilit, tek kilitli	1 Kilit 1 Anahtar	102804	454,20
NA1 asma kilit, üç kilitli	3 Kilit 2 Anahtar	102806	454,20
NA1-2000-6300 kablo tipi mekanik kilit	Kablo	102789	5.620,00
NA1-2000-6300 sabitleme plakası		102894	35,00

NA1 Serisi açık tip şalterlerde yardımcı kontak bloğu dahil olarak ürün üzerinde bulunmaktadır.

Mekanik kilit seçimi için mutlaka okuyunuz:

* Çekmeceli tip için sadece 1 adet 102789 sipariş edilmelidir. * Sabit tip için 1 adet 102789 ve 2 adet 102894 sipariş edilmelidir.

NA8G Serisi

Ayarlı | ZSI Özelliği



	Ürün Tanımı 400/690 V AC	Kesme Kap. Icu (kA)	Termik I (A)	Sipariş Kodu	Birim Fiyat (₺)
Elektronik Kontrol Üniteli Sabit Tip 3 Kutuplu	NA8G-1600 1000 A	50	400-1000	111414	25.727,00
	NA8G-1600 1250 A	50	500-1250	111418	26.105,00
	NA8G-1600 1600 A	50	640-1600	111415	26.843,00
	NA8G-3200 2000 A	50	800-2000	111417	38.611,00
	NA8G-3200 2500 A	50	1000-2500	111421	41.617,00
	NA8G-3200 3200 A	50	1280-3200	111422	42.473,00



NA8G-Özellikler

- Arıza halinde sistemi zararlı etkilerden koruma
- Arıza anında yükü olabildiğince kısa sürede arıza akımına maruz bırakmak.
- Gereksiz triple açmaların önüne geçerek işletme güvenliğini sağlamak.
- Akıllı şebeke uygulamalarında.
- Alçak gerilim dağıtım panosunun akıllı şebekeye bağlantısı.
- Haberleşme yetenekleri sayesinde uzaktan erişim ve sistemin bakımını olanak sağlar.
- Bölgesel Seçicilik Kaskad Bağlantı (ZSI)
- Küçük ebatları sayesinde panoda minimum yer kaplar

Toroid Röle ve Akım Trafosu



	Ürün Tanımı 230/400 V AC	Sipariş Kodu	Birim Fiyat (₺)
Toroid Röle	RDC -01 serisi 0.03-0.5A 1NA/1NK	900001	1.350,00
	RDC -02 serisi 0.025-25A 1NA/1NK	900002	2.210,00
Panoya Montaj Toroid Röle	RDC-11 serisi 0.025-2.5A 1NA/1NK	900004	2.387,00
Toroid	Akım trafosu TTC serisi toroid 60mm	900104	812,10
	Akım trafosu TTC serisi toroid 110mm	900101	1.555,00
	Akım trafosu TTC serisi toroid 160mm	900102	3.710,00
	Akım trafosu TTC serisi toroid 210mm	900103	4.154,00



Akım Trafoları



Ürün Tanımı	Primer Akımı	Sekonder Akımı	Anma Gücü (VA)	Sınıf (Class)	Bara Durumu	Sipariş Kodu	Birim Fiyat (₺)
CT-10 20/5 10VA Cl:0,5 A.G. Akım Trafosu	20	5	10	0.5	Baralı	500101	290,00
CT-10 30/5 10VA Cl:0,5 A.G. Akım Trafosu	30	5	10	0.5	Baralı	500102	283,40
CT-10 40/5 10VA Cl:0,5 A.G. Akım Trafosu	40	5	10	0.5	Baralı	500103	295,20
CT-10 50/5 10VA Cl:0,5 A.G. Akım Trafosu	50	5	10	0.5	Baralı	500104	288,40
CT-10 60/5 10VA Cl:0,5 A.G. Akım Trafosu	60	5	10	0.5	Baralı	500105	283,50
CT-10 75/5 10VA Cl:0,5 A.G. Akım Trafosu	75	5	10	0.5	Baralı	500106	286,10
CT-10 100/5 10VA Cl:0,5 A.G. Akım Trafosu	100	5	10	0.5	Baralı	500107	287,50
CT-10 125/5 10VA Cl:0,5 A.G. Akım Trafosu	125	5	10	0.5	Baralı	500108	280,10
CT-10 150/5 10VA Cl:0,5 A.G. Akım Trafosu	150	5	10	0.5	Baralı	500109	287,50
CT-30 200/5 10VA Cl:0.5 A.G. Akım Trafosu Kalın	200	5	10	0.5	Barasız	500110	214,30
CT-30 250/5 10VA Cl:0,5 A.G. Akım Trafosu	250	5	10	0.5	Barasız	500111	180,60
CT-40 300/5 10VA Cl:0,5 A.G. Akım Trafosu	300	5	10	0.5	Barasız	500112	180,30
CT-40 400/5 10VA Cl:0,5 A.G. Akım Trafosu	400	5	10	0.5	Barasız	500113	174,60
CT-40 500/5 10VA Cl:0,5 A.G. Akım Trafosu	500	5	10	0.5	Barasız	500114	177,30
CT-40 600/5 10VA Cl:0,5 A.G. Akım Trafosu	600	5	10	0.5	Barasız	500115	183,00
CT-60 750/5 10VA Cl:0,5 A.G. Akım Trafosu	750	5	10	0.5	Barasız	500116	255,90
CT-60 800/5 15VA Cl:0,5 A.G. Akım Trafosu	800	5	15	0.5	Barasız	500117	267,60
CT-60 1000/5 15VA Cl:0,5 A.G. Akım Trafosu	1000	5	15	0.5	Barasız	500118	282,20
CT-60 1200/5 15VA Cl:0,5 A.G. Akım Trafosu	1200	5	15	0.5	Barasız	500119	310,70
CT-60 1250/5 15VA Cl:0,5 A.G. Akım Trafosu	1250	5	15	0.5	Barasız	500120	310,70
CT-80 1500/5 15VA Cl:0,5 A.G. Akım Trafosu	1500	5	15	0.5	Barasız	500121	322,80
CT-100 2000/5 15VA Cl:0,5 A.G. Akım Trafosu	2000	5	15	0.5	Barasız	500122	374,30
CT-100 2500/5 15VA Cl:0,5 A.G. Akım Trafosu	2500	5	15	0.5	Barasız	500124	417,60
CT-100 3000/5 15VA Cl:0,5 A.G. Akım Trafosu	3000	5	15	0.5	Barasız	500126	491,00
CT-100 3200/5 15VA Cl:0,5 A.G. Akım Trafosu	3200	5	15	0.5	Barasız	500128	515,00
CT-100 4000/5 30VA Cl:0,5 A.G. Akım Trafosu	4000	5	30	0.5	Barasız	500130	540,00
CT-100 5000/5 30VA Cl:0,5 A.G. Akım Trafosu	5000	5	30	0.5	Barasız	500131	650,00

* Mühürlü akım trafoları için sorunuz.

AG Kuru Tip Kondansatörler



Monofaze Güç Kondansatörleri

Anma Gerilimi (V)	Anma Gücü (kVAR)	Ürün Tanımı	Sipariş Kodu	Birim Fiyat (₺)
230	0.25	NWC6-230V 0.25kvar 1P	799011	170,00
230	0.5	NWC6-230V 0.5kvar 1P	799012	176,00
230	1	NWC6-230V 1kvar 1P	799013	200,00
230	1.5	NWC6-230V 1.5kvar 1P	799014	247,00
230	2.5	NWC6-230V 2.5kvar 1P	799015	320,00
230	5	NWC6-230V 5kvar 1P	799016	585,00
230	7.5	NWC6-230V 7.5kvar 1P	799017	1.060,00
230	10	NWC6-230V 10kvar 1P	799018	1.350,00

Trifaze Güç Kondansatörleri

400	0.5	NWC6-400V 0.5kvar 3P	799019	240,00
400	1	NWC6-400V 1kvar 3P	799020	247,00
400	1.5	NWC6-400V 1.5kvar 3P	799021	283,00
400	2.5	NWC6-400V 2.5kvar 3P	799022	330,00
400	5	NWC6-400V 5kvar 3P	799023	363,00
400	7.5	NWC6-400V 7.5kvar 3P	799024	372,80
400	10	NWC6-400V 10kvar 3P	799025	451,00
400	15	NWC6-400V 15kvar 3P	799026	609,90
400	20	NWC6-400V 20kvar 3P	799029	779,40
400	25	NWC6-400V 25kvar 3P	799030	946,60
400	30	NWC6-400V 30kvar 3P	799031	1.038,00
450	5	NWC6-450V 5kvar 3P	799032	360,00
450	7.5	NWC6-450V 7.5kvar 3P	799033	394,00
450	10	NWC6-450V 10kvar 3P	799034	465,90
450	15	NWC6-450V 15kvar 3P	799035	588,70
450	20	NWC6-450V 20kvar 3P	799036	821,60
450	25	NWC6-450V 25kvar 3P	799037	868,30
450	30	NWC6-450V 30kvar 3P	799038	995,20
525	7.5	NWC6-525V 7.5kvar 3P	799040	478,60
525	10	NWC6-525V 10kvar 3P	799041	520,90
525	15	NWC6-525V 15kvar 3P	799042	656,50
525	20	NWC6-525V 20kvar 3P	799043	910,50
525	25	NWC6-525V 25kvar 3P	799044	1.164,00
525	30	NWC6-525V 30kvar 3P	799045	1.228,00

Şönt Reaktörler - Endüktif Yük Reaktörleri



Monofaze Şönt Reaktörler

Anma Gerilimi (V)	Anma Gücü (kVAr)	Ürün Tanımı	Sipariş Kodu	Birim Fiyat (₺)
230	0.25	Shnt-230V 0.25kvar 1P	500001	729,90
230	0.3	Shnt-230V 0.3kvar 1P	500002	843,00
230	0.5	Shnt-230V 0.5kvar 1P	500003	997,20
230	1	Shnt-230V 1kvar 1P	500004	1.234,00
230	1.5	Shnt-230V 1.5kvar 1P	500005	1.697,00
230	2.5	Shnt-230V 2.5kvar 1P	500006	2.570,00
230	3.5	Shnt-230V 3.5kvar 1P	500007	3.804,00
230	5	Shnt-230V 5kvar 1P	500008	5.346,00
230	7	Shnt-230V 7kvar 1P	500009	5.860,00
230	7.5	Shnt-230V 7.5kvar 1P	500010	6.374,00
230	10	Shnt-230V 10kvar 1P	500011	8.430,00



Trifaze Şönt Reaktörler

Anma Gerilimi (V)	Anma Gücü (kVAr)	Bağlanabilen Şönt Reaktör	Ürün Tanımı	Sipariş Kodu	Birim Fiyat (₺)
400	0.5		Shnt-400V 0.5kvar 3P	500012	2.108,00
400	1		Shnt-400V 1kvar 3P	500013	2.930,00
400	1.5		Shnt-400V 1.5kvar 3P	500014	3.290,00
400	2		Shnt-400V 2kvar 3P	500015	4.215,00
400	2.5		Shnt-400V 2.5kvar 3P	500016	4.318,00
400	3		Shnt-400V 3kvar 3P	500017	4.626,00
400	5		Shnt-400V 5kvar 3P	500018	6.991,00
400	7.5		Shnt-400V 7.5kvar 3P	500019	8.430,00
400	10		Shnt-400V 10kvar 3P	500020	10.897,00
400	12.5		Shnt-400V 12.5kvar 3P	500021	11.822,00
400	15		Shnt-400V 15.0kvar	500022	13.107,00
400	20		Shnt-400V 20kvar 3P	500023	16.448,00
400	25		Shnt-400V 25kvar 3P	500024	18.523,00
400	30		Shnt-400V 30kvar 3P	500025	19.759,00
400	40		Shnt-400V 40kvar 3P	500026	24.696,00
400	50		Shnt-400V 50kvar 3P	500027	32.725,00

Endüktif Yük Sürücü- SVC Yük Sürücü

Anma Gerilimi (V)	Anma Gücü (kVAr)	Bağlanabilen Şönt Reaktör	Ürün Tanımı	Sipariş Kodu	Birim Fiyat (₺)
400	5	3 x 1.5kvar	5kvar SVC yük sürücü (3 x 1.5kvar)	500028	3.084,00
400	10	3 x 3.5kvar	10kvar SVC yük sürücü (3 x 3.5kvar)	500029	3.855,00
400	20	3 x 7kvar	20kvar SVC yük sürücü (3 x 7kvar)	500030	5.963,00
400	30	3 x 10kvar	30kvar SVC yük sürücü (3 x 10kvar)	500031	6.477,00

CJ19 Serisi Kompanzasyon Kontaktörleri

3 Kutup Sabit Tip



Ürün Tanımı	Yardımcı Kontakt	Sipariş Kodu	Birim Fiyat (₺)
Cj19 serisi 3 kutup 7,5 kVAR	1NA+1NK	253731	318,10
CJ19 serisi 3 kutup 12kVAR	1NA+1NK	243764	407,80
CJ19 serisi 3 kutup 18kVAR	1NA+1NK	243881	520,30
CJ19 serisi 3 kutup 20kVAR	1NA+1NK	243998	524,80
CJ19 serisi 3 kutup 25 kVAR	1NA+2NK	253732	718,50
CJ19 serisi 3 kutup 30kVAR	1NA+2NK	244079	893,20
CJ19 serisi 3 kutup 40kVAR	1NA+2NK	253734	1.197,00
CJ19 serisi 3 kutup 50kVAR	1NA+2NK	244160	1.424,00

Harmonik Filtre Reaktörleri



Anma Gerilimi (V)	Anma Gücü (kVAR)	Rezonans Frekansı (Hz)	%p	Ürün Tanımı	Sipariş Kodu	Birim Fiyat (₺)
400	0.83	189	%7	CHNTHFR-%7-189Hz 400V 0.83kvar	500032	1.080,00
400	1.5	189	%7	CHNTHFR-%7-189Hz 400V 1.5kvar	500033	1.234,00
400	2.5	189	%7	CHNTHFR-%7-189Hz 400V 2.5kvar	500034	1.491,00
400	5	189	%7	CHNTHFR-%7-189Hz 400V 5.0kvar	500035	1.902,00
400	6.25	189	%7	CHNTHFR-%7-189Hz 400V 6.25kvar	500036	2.005,00
400	10	189	%7	CHNTHFR-%7-189Hz 400V 10.0kvar	500037	2.365,00
400	12.5	189	%7	CHNTHFR-%7-189Hz 400V 12.5kvar	500038	2.468,00
400	15	189	%7	CHNTHFR-%7-189Hz 400V 15.0kvar	500039	2.673,00
400	20	189	%7	CHNTHFR-%7-189Hz 400V 20.0kvar	500040	3.239,00
400	25	189	%7	CHNTHFR-%7-189Hz 400V 25.0kvar	500041	3.598,00
400	30	189	%7	CHNTHFR-%7-189Hz 400V 30.0kvar	500042	3.907,00
400	40	189	%7	CHNTHFR-%7-189Hz 400V 40.0kvar	500043	4.472,00
400	50	189	%7	CHNTHFR-%7-189Hz 400V 50.0kvar	500044	4.832,00
400	75	189	%7	CHNTHFR-%7-189Hz 400V 75.0kvar	500046	6.014,00

Not: %p, %5,67 ve %14 değerli ürünler için sorunuz.

Motor Koruma ve Kontrol Ürünleri



CHNT

NC1 Serisi Kontaktörler

3 Kutup 220 VA AC



Ürün Tanımı	Anma Gücü P(kW)400V	Anma Akımı I(A) (AC3)	Termik Akım Ith(AC1)	Yardımcı Kontakt	Sipariş Kodu	Birim Fiyat (₺)
NC1-0901M	4	9	20	1NK	220796	120,90
NC1-0910M	4	9	20	1NA	221029	120,90
NC1-1201M	5,5	12	20	1NK	221124	126,90
NC1-1210M	5,5	12	20	1NA	221355	126,90
NC1-1801M	7,5	18	32	1NK	221446	146,50
NC1-1810M	7,5	18	32	1NA	221541	146,50
NC1-2501M	11	25	40	1NK	221630	196,40
NC1-2510M	11	25	40	1NA	221861	196,40
NC1-3201M	15	32	50	1NK	221953	301,90
NC1-3210M	15	32	50	1NA	222048	301,90
NC1-4011M	18,5	40	60	1NA+1NK	222268	490,70
NC1-5011M	22	50	80	1NA+1NK	222489	588,70
NC1-6511M	30	65	80	1NA+1NK	222710	726,00
NC1-8011M	37	80	95	1NA+1NK	222931	935,90
NC1-9511M	45	95	95	1NA+1NK	223152	1.039,00

4 Kutup 220 VA AC



Ürün Tanımı	Anma Gücü P(kW)400V	Anma Akımı I(A) (AC3)	Termik Akım Ith(AC1)	Sipariş Kodu	Birim Fiyat (₺)
NC1-0904M	4	9	20	220890	143,90
NC1-1204M	5,5	12	20	221216	165,00
NC1-2504M	11	25	40	221722	249,90
NC1-4004M	18,5	40	60	222139	658,40
NC1-5004M	22	50	80	222360	751,10
NC1-6504M	30	65	80	222581	879,30
NC1-8004M	37	80	95	222802	1.171,00
NC1-9504M	45	95	95	223023	1.233,00

NC1 Serisi Kontaktörler

3 Kutup 24 VDC

Ürün Tanımı	Anma Gücü P(kW)400V	Anma Akımı I(A) (AC3)	Termik Akım Ith(AC1)	Yardımcı Kontakt	Sipariş Kodu	Birim Fiyat (₺)
NC1-0901Z	4	9	20	1NK	220881	248,00
NC1-0910Z	4	9	20	1NA	221112	248,00
NC1-1201Z	5.5	12	20	1NK	221207	270,20
NC1-1210Z	5.5	12	20	1NA	221437	270,20
NC1-1801Z	7.5	18	32	1NK	221529	284,50
NC1-1810Z	7.5	18	32	1NA	221621	284,50
NC1-2501Z	11	25	40	1NK	221713	400,60
NC1-2510Z	11	25	40	1NA	221944	400,60
NC1-3201Z	15	32	50	1NK	222036	537,30
NC1-3210Z	15	32	50	1NA	222130	537,30
NC1-4011Z	18.5	40	60	1NA + 1NK	222351	964,80
NC1-5011Z	22	50	80	1NA + 1NK	222572	1.037,00
NC1-6511Z	30	65	80	1NA + 1NK	222793	1.209,00
NC1-8011Z	37	80	95	1NA + 1NK	223014	1.476,00
NC1-9511Z	45	95	95	1NA + 1NK	223235	1.649,00



3 Kutup 24 VAC

Ürün Tanımı	Anma Gücü P(kW)400V	Anma Akımı I(A) (AC3)	Termik Akım Ith(AC1)	Yardımcı Kontakt	Sipariş Kodu	Birim Fiyat (₺)
NC1-0901 24V 50/60Hz	4	9	20	1NK	220805	121,10
NC1-0910 24V 50/60Hz	4	9	20	1NA	221038	121,10
NC1-1201 24V 50/60Hz	5.5	12	20	1NK	221133	127,30
NC1-1210 24V 50/60Hz	5.5	12	20	1NA	221363	127,30
NC1-1801 24V 50/60Hz	7.5	18	32	1NK	221455	147,10
NC1-1810 24V 50/60Hz	7.5	18	32	1NA	221550	147,10
NC1-2501 24V 50/60Hz	11	25	40	1NK	221639	196,80
NC1-2510 24V 50/60Hz	11	25	40	1NA	221870	196,80
NC1-3201 24V 50/60Hz	15	32	50	1NK	221962	302,80
NC1-3210 24V 50/60Hz	15	32	50	1NA	222056	302,80
NC1-4011 24V 50/60Hz	18.5	40	60	1NA + 1NK	222277	492,10
NC1-5011 24V 50/60Hz	22	50	80	1NA + 1NK	222498	590,30
NC1-6511 24V 50/60Hz	30	65	80	1NA + 1NK	222719	728,10
NC1-8011 24V 50/60Hz	37	80	95	1NA + 1NK	222940	938,50
NC1-9511 24V 50/60Hz	45	95	95	1NA + 1NK	223161	1.042,00



NC1 Serisi Kontaktörler

3 Kutup 110 VAC



Ürün Tanımı	Anma Gücü P(kW)400V	Anma Akımı I(A) (AC3)	Termik Akım Ith(AC1)	Yardımcı Kontakt	Sipariş Kodu	Birim Fiyat (₺)
NC1-0901 110V 50/60Hz	4	9	20	1NK	220787	121,10
NC1-0910 110V 50/60Hz	4	9	20	1NA	221020	121,10
NC1-1201 110V 50/60Hz	5.5	12	20	1NK	221115	127,30
NC1-1210 110V 50/60Hz	5.5	12	20	1NA	221346	127,30
NC1-1801 110V 50/60Hz	7.5	18	32	1NK	221440	147,10
NC1-1810 110V 50/60Hz	7.5	18	32	1NA	221532	147,10
NC1-2501 110V 50/60Hz	11	25	40	1NK	221624	196,80
NC1-2510 110V 50/60Hz	11	25	40	1NA	221852	196,80
NC1-3201 110V 50/60Hz	15	32	50	1NK	221947	302,80
NC1-3210 110V 50/60Hz	15	32	50	1NA	222039	302,80
NC1-4011 110V 50/60Hz	18.5	40	60	1NA + 1NK	222259	492,10
NC1-5011 110V 50/60Hz	22	50	80	1NA + 1NK	222480	590,30
NC1-6511 110V 50/60Hz	30	65	80	1NA + 1NK	222701	728,10
NC1-8011 110V 50/60Hz	37	80	95	1NA + 1NK	222922	938,50
NC1-9511 110V 50/60Hz	45	95	95	1NA + 1NK	223143	1.042,00



NC1 Serisi Yardımcı Aksesuarlar



Açıklama	Termik Akım Ith (A) AC1	Yardımcı Kontakt	Sipariş Kodu	Birim Fiyat (₺)	Kutu Adeti	
Yardımcı Kontakt Bloğu	F4-22	10	2NA+2NK	257019	53,58	10
	F4-02	10	2NK	257020	32,67	10
	F4-04	10	4NK	257021	53,58	10
	F4-11	10	1NA+1NK	257022	32,67	10
	F4-13	10	1NA+3NK	257023	53,58	10
	F4-20	10	2NA	257024	32,67	10
	F4-31	10	3NA+1NK	257025	53,58	10
	F4-40	10	4NA	257026	53,58	10
Yardımcı Kontakt Yana Takılan Tip	NCF1-11C	10	1NA+1NK	223238	70,42	10

Açıklama	Sipariş Kodu	Birim Fiyat (₺)	
Mekanik Kilit	NC1-09-32 Mekanik kilit	256717	73,36
	NC1-40-65 Mekanik kilit	777989	87,29
	NC1-80-95 & NC1-4004-6504 Mekanik kilit	777988	102,80



NXC Serisi Kontaktörler

3 Kutup 220V AC



Ürün Tanımı	Anma Gücü P(kW)400V	Anma Akımı I(A) (AC3)	Termik Akım Ith(AC1)	Yardımcı Kontakt	Sipariş Kodu	Birim Fiyat (₺)
NXC-09 220V 50/60Hz	4	9	20	1NA+1NK	925353	123,90
NXC-12 220V 50/60Hz	5,5	12	25	1NA+1NK	925479	129,90
NXC-18 220V 50/60Hz	7,5	18	32	1NA+1NK	925607	151,40
NXC-25 220V 50/60Hz	11	25	40	1NA+1NK	925735	207,50
NXC-32 220V 50/60Hz	15	32	50	1NA+1NK	925213	320,00
NXC-38 220V 50/60Hz	18,5	38	50	1NA+1NK	925859	383,00
NXC-40 220V 50/60Hz	18,5	40	60	1NA+1NK	925923	490,70
NXC-50 220V 50/60Hz	22	50	80	1NA+1NK	925986	588,70
NXC-65 220V 50/60Hz	30	65	80	1NA+1NK	938049	726,00
NXC-75 220V 50/60Hz	37	75	90	1NA+1NK	938113	935,00
NXC-85 220V 50/60Hz	37	85	100	1NA+1NK	938177	1.000,00
NXC-100 220V 50/60Hz	45	100	110	1NA+1NK	925416	1.039,00

Daha büyük güçler için sorunuz.

NXC Serisi Yardımcı Aksesuarlar



Açıklama	Termik Akım Ith (A) AC1	Yardımcı Kontakt	Sipariş Kodu	Birim Fiyat (₺)	Kutu Adeti	
Yardımcı Kontakt Bloğu	AX-3X/22	10	2NA+2NK	938251	53,58	10
	AX-3X/31	10	3NA+1NK	938252	53,58	10
	AX-3X/13	10	1NA+3NK	938253	53,58	10
	AX-3X/40	10	4NA	938254	53,58	10
	AX-3X/04	10	4NK	938255	53,58	10
	AX-3X/11	10	1NA+1NK	938256	32,67	10
	AX-3X/02	10	2NK	938257	32,67	10
	AX-3X/20	10	2NA	938258	32,67	10
Yardımcı Kontakt Bloğu Yana Takılan Tip	AX-3C/11	10	1NA+1NK	938259	70,42	10
Mekanik Kilit	Açıklama		Sipariş Kodu	Birim Fiyat (₺)		
	NXC-09-38 Mekanik kilit		256717	73,36		
	NXC-40-65 Mekanik kilit		777989	87,29		
	NXC-75-100 Mekanik kilit		777988	102,80		

NC2 Serisi Kontaktörler

AC-1 AC-3 AC-4 Sınıfı



	Ürün Adı	Anma Gücü P(kW). 400 V AC	Anma Akımı I (A). AC3	Termik Akım Ith (A) AC1	Sipariş Kodu	Birim Fiyat (₺)
3 Kutuplu 220 V AC	NC2-115M	55	115	200	671433	1.817,00
	NC2-150M	75	150	200	671398	1.986,00
	NC2-185M	90	185	275	671435	2.588,00
	NC2-225M	110	225	275	671400	3.113,00
	NC2-265M	132	265	315	236732	3.633,00
	NC2-330M	160	330	380	236055	5.145,00
	NC2-400M	200	400	450	236154	5.161,00
	NC2-500M	250	500	630	236254	8.550,00
4 Kutuplu 220 V AC	NC2-115M4	55	115	200	671434	2.498,00
	NC2-150M4	75	150	200	671399	2.730,00
	NC2-185M4	90	185	275	671436	3.519,00
	NC2-225M4	110	225	275	671401	3.633,00
	NC2-265M4	132	265	315	671403	5.314,00
	NC2-330M4	160	330	380	236103	6.962,00
	NC2-400M4	200	400	450	236203	7.387,00
	NC2-630M4	335	600	800	236352	12.706,00



NC2 Serisi Kontaktör Aksesuarları



	Ürün Adı	Yardımcı Kontakt	Sipariş Kodu	Birim Fiyat (₺)	Kutu Adeti
Yardımcı Kontakt Bloğu	NCF4-20	2NA	257024	32,68	10
	NCF4-02	2NK	257020	32,68	10
	NCF4-11	1NA+1NK	257022	32,68	10
	NCF4-40	4NA	257026	53,58	10
	NCF4-04	4NK	257021	53,58	10
	NCF4-22	2NA+2NK	257019	53,58	10
	NCF4-13	1NA+3 NK	257023	53,58	10
	NCF4-31	3NA+1 NK	257025	53,58	10



	Ürün Adı	Ayar Sahası	Geciktirme	Sipariş Kodu	Birim Fiyat (₺)	
Zaman Rölesi	NCF5-T0	0,1s-3s	Çekme	1NA+1NK	258021	317,90
	NCF5-T2	0,1s-30s	Çekme	1NA+1NK	258022	317,90
	NCF5-T4	10s-180s	Çekme	1NA+1NK	258023	317,90
	NCF5-D0	0,1s-3s	Düşme	1NA+1NK	258018	317,90
	NCF5-D2	0,1s-30s	Düşme	1NA+1NK	258019	317,90
	NCF5-D4	10s-180s	Düşme	1NA+1NK	258020	317,90



	Ürün Adı	Uyumlu Kontaktörler	Sipariş Kodu	Birim Fiyat (₺)
Yatay Mekanik Kilit	NC2-H01	NC2-115/150	237995	157,50
	NC2-H02	NC2-185/225	237997	245,50
	NC2-H03	NC2 265/330/400/500	237999	280,30
	NC2-H04	NC2-630	237993	459,60



	Ürün Adı	Sipariş Kodu	Birim Fiyat (₺)
Bobinler	NC2-115/150 220V AC	671926	378,50
	NC2-185/225 220V AC	671924	453,30
	NC2-265/330 220V AC	671992	688,80
	NC2-400 220V AC	671998	925,40
	NC2-500 220V AC	671997	950,10
	NC2-630 220V AC	671996	1.183,00



Termik Röleler

NC1 Kontaktör Serisine Uyumlu Termik Röleler



Termikler	Uyumlu Kontaktörler	Termik Ayar Sahası	Sipariş Kodu	Birim Fiyat (₺)
NR2-25/0.16	NC1-09...32	0,1-0,16 A	268132	177,80
NR2-25/0.25	NC1-09...32	0,16-0,25 A	268133	177,80
NR2-25/0.4	NC1-09...32	0,25-0,40 A	268134	177,80
NR2-25/0.63	NC1-09...32	0.40-0,63 A	268135	177,80
NR2-25/1	NC1-09...32	0,63-1 A	268136	177,80
NR2-25/1.6	NC1-09...32	1-1.6 A	268137	177,80
NR2-25/2	NC1-09...32	1,25-2 A	268138	177,80
NR2-25/2.5	NC1-09...32	1.6-2,5 A	268131	177,80
NR2-25/4	NC1-09...32	2,5-4 A	268139	177,80
NR2-25/6	NC1-09...32	4-6 A	268140	177,80
NR2-25/8	NC1-09...32	5,5-8A	268141	177,80
NR2-25/10	NC1-09...32	7-10 A	268096	177,80
NR2-25/13	NC1-09...32	9-13 A	268095	177,80
NR2-25/18	NC1-09...32	12-18 A	268097	177,80
NR2-25/25	NC1-09...32	17-25 A	268142	177,80
NR2-36/32	NC1-32	23-32 A	268143	234,50
NR2-36/36	NC1-32	28-36 A	268144	244,10
NR2-93/32	NC1-40...95	23-32 A	268145	324,40
NR2-93/40	NC1-40...95	30-40 A	268146	331,00
NR2-93/50	NC1-40...95	37-50 A	268147	337,60
NR2-93/65	NC1-40...95	48-65 A	268148	344,30
NR2-93/70	NC1-40...95	55-70 A	268149	554,80
NR2-93/80	NC1-40...95	63-80 A	268150	578,10
NR2-93/93	NC1-40...95	80-93 A	268151	705,10

Ürün Tanımı	Uyumlu Termik	Sipariş Kodu	Birim Fiyat (₺)	
DIN Raya Montaj Bloğu	MB-4	NR2-93	837996	110,00
	MB-3	NR2-36	837997	45,00
	MB-2	NR2-25	837998	36,00
	MB-1	NR2-11,5	837999	30,00



NXC Kontaktör Serisine Uyumlu Termik Röleler



Termikler	Termik Ayar Sahası	Sipariş Kodu	Birim Fiyat (₺)
NXR-25 0.1-0.16A	0,1-0,16 A	837105	135,10
NXR-25 0.16-0.25A	0,16-0,25 A	837106	135,10
NXR-25 0.25-0.4A	0,25-0,40 A	837107	135,10
NXR-25 0.4-0.63A	0.40-0,63 A	837108	135,10
NXR-25 0.63-1A	0,63-1 A	837109	135,10
NXR-25 1-1.6A	1-1.6 A	837110	135,10
NXR-25 1.25-2A	1,25-2 A	837111	135,10
NXR-25 1.6-2.5A	1.6-2,5 A	837112	135,10
NXR-25 2.5-4A	2,5-4 A	837113	135,10
NXR-25 4-6A	4-6 A	837114	135,10
NXR-25 5.5-8A	5,5-8A	837115	135,10
NXR-25 7-10A	7-10 A	837116	135,10
NXR-25 9-13A	9-13 A	837117	135,10
NXR-25 12-18A	12-18 A	837118	135,10
NXR-25 17-25A	17-25 A	837119	135,10
NXR-38 23A-32A	23-32A	837120	151,00
NXR-38 30A-38A	30-38A	837121	153,00
NXR-100 23A-32A	23-32A	837122	222,00
NXR-100 30A-40A	30-40A	837123	232,00
NXR-100 37A-50A	37-50A	837124	237,00
NXR-100 48A-65A	48-65A	837125	240,00
NXR-100 55A-70A	55-70A	837126	245,00
NXR-100 63A-80A	63-80A	837127	268,00
NXR-100 80A-93A	80-93A	837128	278,00
NXR-100 80A-100A	80-100A	837129	319,00

Ürün Tanımı	Uyumlu Termik	Sipariş Kodu	Birim Fiyat (₺)	
DIN Raya Montaj Bloğu	MB-4	NXR-100	837996	110,00
	MB-3	NXR-38	837997	45,00
	MB-2	NXR-25	837998	36,00
	MB-1	NXR-12	837999	30,00

Daha büyük akım değerleri için sorunuz.

NC2 Kontaktör Serisine Uyumlu Termik Röleler



Termikler	Uyumlu Kontaktörler	Termik Ayar Sahası	Sipariş Kodu	Birim Fiyat (₺)
NR2-150	NC2-115..120	80-104A	268292	1.026,00
NR2-150	NC2-115..120	95-120A	268293	1.083,00
NR2-150	NC2-115..120	110-150A	268294	1.140,00
NR2-200	NC2-115..225	80-125A	268295	1.549,00
NR2-200	NC2-115..225	100-160A	268296	1.630,00
NR2-200	NC2-115..225	125-200A	268297	1.712,00
NR2-630	NC2-185..630	160-250A	268298	1.875,00
NR2-630	NC2-185..630	200-315A	268299	1.933,00
NR2-630	NC2-185..630	250-400A	268300	2.527,00
NR2-630	NC2-185..630	315-500A	268301	3.088,00
NR2-630	NC2-185..630	400-630A	268302	3.363,00



NXC Serisi Mini Kontaktörler



Ürün Tanımı	Anma Gücü P(kW). 400 V AC	Anma Akımı I (A). AC3	Termik Akım Ith (A) AC1	Yardımcı Kontakt	Sipariş Kodu	Birim Fiyat (₺)	Kutu Adeti	
3 Kutuplu 220 V AC	NXC-06M10	2,2	6	20	1NA	836572	112,00	1
	NXC-09M10	4	9	20	1NA	836576	117,00	1
	NXC-12M10	5,5	12	20	1NA	836580	123,00	1
	NXC-16M10	7,5	16	22	1NA	171735	186,00	1
3 Kutuplu 24 V DC	NXC-06M10/Z	2,2	6	20	1NA	836657	180,00	1
	NXC-09M10/Z	4	9	20	1NA	836660	195,00	1
	NXC-12M10/Z	5,5	12	20	1NA	836663	210,00	1
	NXC-16M10/Z	7,5	16	22	1NA	171740	225,00	1
Yardımcı Kontakt Bloğu	AX-3M/40			10	4NA	925184	52,00	
	AX-3M/31			10	3NA+1NK	925185	52,00	
	AX-3M/22			10	2NA+2NK	925186	52,00	
	AX-3M/13			10	1NA+3NK	925187	52,00	
	AX-3M/04			10	4NK	925188	52,00	
	AX-3M/20			10	2NA	925189	31,00	
	AX-3M/11			10	1NA+1NK	925190	31,00	
	AX-3M/02			10	2NK	925191	31,00	



NC6 Serisi Mini Kontaktörler

AC-1 AC-3 AC-4 Sınıfı



Ürün Tanımı	Anma Gücü P(kW). 400 V AC	Anma Akımı I (A). AC3	Termik Akım Ith (A) AC1	Yardımcı Kontak	Sipariş Kodu	Birim Fiyat (₺)	Kutu Adeti	
3 Kutuplu 220 V AC	NC6-0610M	2,2	6	20	1NA	247436	112,00	1
	NC6-0601M	2,2	6	20	1NK	247337	112,00	1
	NC6-0910M	4	9	20	1NA	247568	117,00	1
	NC6-0901M	4	9	20	1NK	247469	117,00	1



3 Kutuplu 24 V AC	NC6-0610M	2,2	6	20	1NA	247445	180,00	1
	NC6-0601M	2,2	6	20	1NK	247346	180,00	1
	NC6-0910M	4	9	20	1NA	247576	195,00	1
	NC6-0901M	4	9	20	1NK	247478	195,00	1



Yardımcı Kontak Bloğu	NCF6-20	NCF6-02	NCF6-11	NCF6-40	NCF6-04	NCF6-22	NCF6-13	NCF6-31
	10	10	10	10	10	10	10	10
	2NA	2NK	1NA+1NK	4NA	4NK	2NA+2NK	1NA+3 NK	3NA+1 NK
	261006	261002	261004	261009	261003	261007	261005	261008
	66,71	66,71	66,71	85,26	85,26	85,26	85,26	85,26
	2	2	2	2	2	2	2	2



Mini Termik	NR2-11.5/0.16	NR2-11.5/0.25	NR2-11.5/0.4	NR2-11.5/0.63	NR2-11.5/1	NR2-11.5/1.6	NR2-11.5/2	NR2-11.5/2.5	NR2-11.5/4	NR2-11.5/6	NR2-11.5/8	NR2-11.5/10	NR2-11.5/13
	0.1-0.16 A	0.16-0.25A	0.25-0.4 A	0.4-0.63A	0.63-1 A	1.0-1,6 A	1.25-2 A	2.0-2.5 A	2.5-4 A	4-6 A	5.5-8 A	7-10 A	9-13 A
	1NA+1NK	1NA+1NK	1NA+1NK	1NA+1NK	1NA+1NK	1NA+1NK	1NA+1NK	1NA+1NK	1NA+1NK	1NA+1NK	1NA+1NK	1NA+1NK	1NA+1NK
	268165	268166	268167	268168	268169	268170	268171	268172	268173	268174	268175	268176	268177
	199,80	199,80	199,80	199,80	199,80	199,80	199,80	199,80	199,80	199,80	199,80	199,80	199,80
	2	2	2	2	2	2	2	2	2	2	2	2	2

Uyumlu Termik

Birim Fiyat (₺)
(2 li Kutu)

DIN raya Montaj Bloğu	NAD-11.5	NR2-11.5	837999	88,95	1
-----------------------	----------	----------	--------	-------	---



NS2X Serisi Motor Koruma Şalterleri

Termik Manyetik



Ürün Tanımı	Anma Gücü P(kW), 400 V AC	Kesme Kap. Icu (kA), 400 V AC	Termik Akım Ith (A) AC1	Sipariş Kodu	Birim Fiyat (₺)	
3 Kutuplu 220 V AC	NS2-25X	-	100	0.1-0.16 A	495176	265,00
	-	-	100	0.16-0.25 A	495177	265,00
	-	-	100	0.25-0.4 A	495178	265,00
	-	-	100	0.4-0.63 A	495179	280,30
	--	-	100	0.63-1 A	495180	280,30
	0,37	100	1-1.6 A	495181	280,30	
	0,75	100	1.6-2,5 A	495182	280,30	
	1,5	100	2,5-4 A	495183	280,30	
	2,2	100	4-6,3 A	495184	291,70	
	4,0	100	6-10 A	495185	291,70	
	5,5	15	9-14 A	495186	295,20	
	7,5	15	13-18 A	495187	302,80	
	11,0	15	17-23 A	495188	310,40	
	11,0	15	20-25 A	495189	310,40	
	15,0	15	24-32 A	139373	459,60	
NS2-80B	18,5	15	25-40 A	495087	874,90	
	30,0	15	40-63 A	495088	932,20	
	37,0	15	63-80 A	495089	1.292,00	

NS2 Serisi Motor Koruma Şalterleri Aksesuarları

		Çalışma Sahası	Gerilim	Sipariş Kodu	Birim Fiyat (₺)
Düşük Gerilim Açtırma	NS2-UV380	- %35-%70	380V	495989	160,60
	NS2-UV220	%35-%70	220V	495986	160,60
Uzaktan Açtırma	NS2-SH380	- %70-%110	380V	495980	160,60
	NS2-SH220	%70-%110	220V	495977	160,60
Yardımcı Kontak üstüne Montaj	NS2-AE20	- 2NA	2.5A	495948	57,67
	NS2-AE11	1NA+1 NK	2.5A	495968	57,67
Yardımcı Kontak sağ/ sola Montaj	NS2-AU20	- 2NA	6A	495951	90,10
	NS2-AU11	1NA+1 NK	6A	495996	90,10
	NS2-80B-AU11	1NA+1 NK	6A	495972	90,10
Hata ve Ani Açtırma Kontakları-sola Montaj	NS2-FA0110	- 1NA+1 NK	6A	495956	97,29
	NS2-FA1010	1NA+1 NK	6A	495962	97,29
IP Sınıfı Yüksek Kutular	NS2-MC01	Suya Karşı Koruma Sınıfı Yüksek stop Butonlu Kutu		495945	253,80
	NS2-MC	Suya Karşı Kouması Yüksek		495997	198,80



NQ3 Serisi Kutulu Yolvericiler

Termik Korumalı



Ürün Tanımı	Anma Gücü P(kW). 400 V AC	Ayar Sahası	Sipariş Kodu	Birim Fiyat (₺)	
400 VAC 50/60 Hz (Kontrol Gerilimi 380 V AC)	NQ3-5.5P 380 V/1.6A	-	1-1,6	496436	493,70
	NQ3-5.5P 380 V/2.5A	-	1,6-2,5	496440	493,70
	NQ3-5,5P 380 V/4A	-	2,5-4	496442	493,70
	NQ3-5,5 P 380 V/6A	5,5	4-6,0	496443	513,40
	NQ3-5,5 P 380 V/8A	5,5	5,5-8	496444	513,40
	NQ3-5,5 P 380 V/10A	5,5	7-10,0	496437	513,40
	NQ3-5.5 P 380 V/13A	5,5	9-13,0	496438	513,40
	NQ3-11/2 380 V/18A	11	12-18,0	496359	696,50
NQ3-11/3 380 V/25 A	11	17-25	496361	696,50	
400 VAC 50/60 Hz (Kontrol Gerilimi 220 V AC)	NQ3-5.5P 220 V/1.6A	-	1-1,6	496399	493,70
	NQ3-5.5P 220 V/2.5A	-	1,6-2,5	496403	493,70
	NQ3-5,5P 220 V/4A	-	2,5-4	496405	493,70
	NQ3-5,5 P 220 V/6A	5,5	4-6,0	496406	513,40
	NQ3-5,5 P220 V/8A	5,5	5,5-8	496407	513,40
	NQ3-5,5 P 220 V/10A	5,5	7-10,0	496400	513,40
	NQ3-5.5 P 220 V/13A	5,5	9-13,0	496401	513,40
	NQ3-11/2 220 V/18A	11	12-18,0	496332	696,50
NQ3-11/3 220 V/25 A	11	17-25	496334	696,50	



Bağlantı Şeması

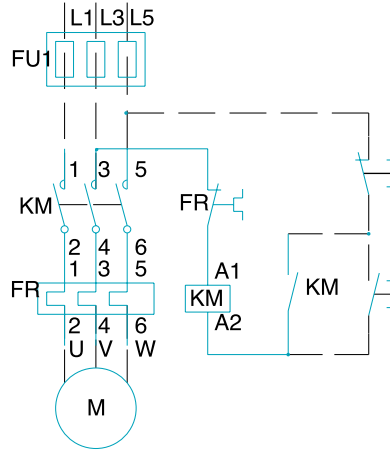

Kontrol beslemesi kaynaktan

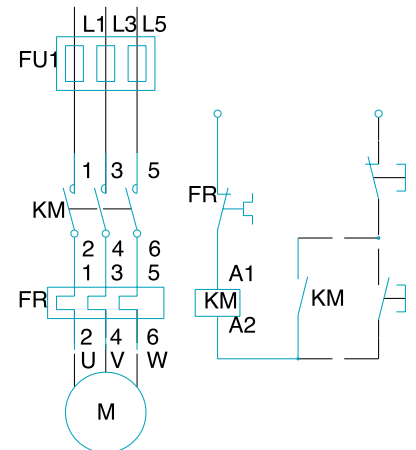

Kontrol beslemesi dışardan

Boyutlar

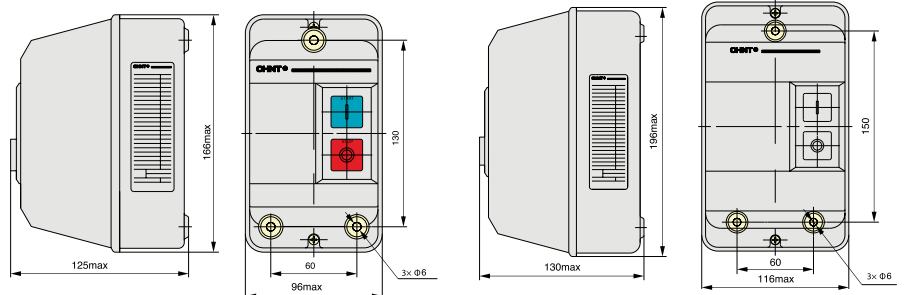

NQ3-5 5P

NQ3-11P

NJDC Test Butonlu Endüstriyel Röle

2 Kontaklı 8 Pinli 7.5A

Ürün Tanımı	Sipariş Kodu	Birim Fiyat (₺)	Kutu Adeti
NJDC-12/2Z DC12V	651112	77,84	10
NJDC-12/2Z DC24V	651114	77,84	10
NJDC-12/2Z DC110V	651111	77,84	10
NJDC-12/2Z DC220V	651113	77,84	10
NJDC-12/2 AC24V	651109	77,84	10
NJDC-12/2 AC110V	651107	77,84	10
NJDC-12/2 AC220V	651108	77,84	10
NJDC-12/2 AC380V	651110	77,84	10



3 Kontaklı 11 Pinli 7.5A

Ürün Tanımı	Sipariş Kodu	Birim Fiyat (₺)	Kutu Adeti
NJDC-12/3Z DC12V	651120	88,95	10
NJDC-12/3Z DC24V	651122	88,95	10
NJDC-12/3Z DC110V	651119	88,95	10
NJDC-12/3Z DC220V	651121	88,95	10
NJDC-12/3 AC24V	651117	88,95	10
NJDC-12/3 AC110V	651115	88,95	10
NJDC-12/3 AC220V	651116	88,95	10

NJDC Endüstriyel Röle ve Soketleri

Yüksek Akım Kapasitesi | 10 A, 8 Bacaklı Test Butonlu



Ürün Tanımı	Sipariş Kodu	Birim Fiyat (₺)
JQX-10F 2Z İçin 8 Pinli soket CZF08A	146140	14,65
JQX-10F 2Z İçin 8 Pinli soket CZF08A-E	146141	16,69
JQX-10F 3Z İçin 11 Pinli soket CZF11A	146142	20,39
JQX-10F 3Z İçin 11 Pinli soket CZF11A-E	146143	21,32



CN Serisi Pano İklimlendirme Ekipmanları



Ürün Tanımı	Kontakt	Renk	Sipariş Kodu	Birim Fiyat (₺)	Kutu Adeti
CN Serisi Termostat - Soğutma	1NO	Mavi	500500	71,14	10
CN Serisi Termostat- Isıtma	1NK	Kırmızı	500501	71,14	10

EKO Serisi Ø22mm Plastik Seri Butonlar ve Sinyaller

EKO Serisi 22mm Plastik Sinyal Lambaları



Ürün Tanımı	Nominal Gerilim(V)	Renk	Sipariş Kodu	Birim Fiyat (₺)	Kutu Adeti
EKO Serisi 220V AC Sinyal Lambası	220V AC	Kırmızı	500502	11,35	25
EKO Serisi 220V AC Sinyal Lambası	220V AC	Yeşil	500503	11,35	25
EKO Serisi 220V AC Sinyal Lambası	220V AC	Sarı	500504	11,35	25
EKO Serisi 220V AC Sinyal Lambası	220V AC	Mavi	500505	11,85	25
EKO Serisi 220V AC Sinyal Lambası	220V AC	Beyaz	500506	11,85	25
EKO Serisi 220V DC Sinyal Lambası	220V DC	Kırmızı	500507	11,35	25
EKO Serisi 220V DC Sinyal Lambası	220V DC	Yeşil	500508	11,35	25
EKO Serisi 220V DC Sinyal Lambası	220V DC	Sarı	500509	11,35	25
EKO Serisi 220V DC Sinyal Lambası	220V DC	Mavi	500510	11,85	25
EKO Serisi 220V DC Sinyal Lambası	220V DC	Beyaz	500511	11,85	25
EKO Serisi 110V AC/DC Sinyal Lambası	110V AC/DC	Kırmızı	500512	11,35	25
EKO Serisi 110V AC/DC Sinyal Lambası	110V AC/DC	Yeşil	500513	11,35	25
EKO Serisi 110V AC/DC Sinyal Lambası	110V AC/DC	Sarı	500514	11,35	25
EKO Serisi 110V AC/DC Sinyal Lambası	110V AC/DC	Mavi	500515	11,85	25
EKO Serisi 110V AC/DC Sinyal Lambası	110V AC/DC	Beyaz	500516	11,85	25
EKO Serisi 24V AC/DC Sinyal Lambası	24V AC/DC	Kırmızı	500517	11,35	25
EKO Serisi 24V AC/DC Sinyal Lambası	24V AC/DC	Yeşil	500518	11,35	25
EKO Serisi 24V AC/DC Sinyal Lambası	24V AC/DC	Sarı	500519	11,35	25
EKO Serisi 24V AC/DC Sinyal Lambası	24V AC/DC	Mavi	500520	11,85	25
EKO Serisi 24V AC/DC Sinyal Lambası	24V AC/DC	Beyaz	500521	11,85	25

EKO Serisi 22mm Plastik Butonlar



Ürün Tanımı	Kontakt	Renk	Sipariş Kodu	Birim Fiyat (₺)	Kutu Adeti
EKO Serisi 1NK Kırmızı Düz Yaylı Buton	1 NK	Kırmızı	500522	15,50	15
EKO Serisi 1NA Yeşil Düz Yaylı Buton	1 NA	Yeşil	500523	15,50	15
EKO Serisi 1NA Sarı Düz Yaylı Buton	1 NA	Sarı	500524	15,50	15
EKO Serisi 1NA Mavi Düz Yaylı Buton	1 NA	Mavi	500525	15,50	15
EKO Serisi 1NA Beyaz Düz Yaylı Buton	1 NA	Beyaz	500526	15,50	15
EKO Serisi 1NA Siyah Düz Yaylı Buton	1 NA	Siyah	500527	15,50	15

*Not: Kırmızı renk dışında NK kontaklı butonlarımız da mevcuttur. Sipariş için lütfen sorunuz.

**Not: 1NA+1NK kontak kombinasyonlu butonlarımız da mevcuttur. Sipariş için lütfen sorunuz.



EKO Serisi 22mm İkiz Butonlar

Ürün Tanımı	Kontakt	Renk	Sipariş Kodu	Birim Fiyat (₺)	Kutu Adeti
EKO Serisi 1NA+1NK İkiz Yaylı Buton	1NA+1NK	Kırmızı-Yeşil	500535	24,70	10



EKO Serisi 22mm Plastik Acil Stop Butonu

Ürün Tanımı	Kontakt	Renk	Sipariş Kodu	Birim Fiyat (₺)	Kutu Adeti
EKO Serisi 40mm 1NK Kırmızı Acil Stop Butonu	1 NK	Kırmızı	500528	23,00	10



EKO Serisi 22mm Plastik Mandal Butonlar

Ürün Tanımı	Kontakt	Pozisyon	Sipariş Kodu	Birim Fiyat (₺)	Kutu Adeti
EKO Serisi 1NA Kalıcılı 0-1 Mandal Buton	1 NA	↘	500529	19,60	12
EKO Serisi 2NA Kalıcılı 1-0-2 Mandal Buton	2 NA	↘↘	500530	25,00	12
EKO Serisi 1NA Yay Dönüşlü 0-1 Mandal Buton	1 NA	↙	500531	24,60	12
EKO Serisi 2NA Yay Dönüşlü 1-0-2 Mandal Buton	2 NA	↙↙	500532	34,00	12



EKO Serisi İlave Kontakt Bloklar

Ürün Tanımı	Kontakt	Sipariş Kodu	Birim Fiyat (₺)	Kutu Adeti
EKO Serisi 1NK İlave Kontakt Blok	1 NK	500533	8,30	50
EKO Serisi 1NA İlave Kontakt Blok	1 NA	500534	8,30	50

ND16 Plastik Seri Sinyal Lambası (LED)



Ürün Tanımı	24/230 V AC	Renk	Sipariş Kodu	Birim Fiyat (₺)	Kutu Adeti
Açılı Kafalı Kısa Gövde 1NA	22DS/2 24V	Beyaz	592936	13,62	10
		Turuncu	593154	13,62	10
		Kırmızı	592938	13,62	10
		Sarı	592939	13,62	10
		Mavi	592937	13,62	10
		Yeşil	592940	13,62	10
Açılı Kafalı Kısa Gövde 1NA	22DS/4 220V	Kırmızı	592718	13,62	10
		Sarı	592719	13,62	10
		Yeşil	592720	13,62	10

Buzzer



Ürün Tanımı	Sipariş Kodu	Birim Fiyat (₺)	Kutu Adeti
ND-16F Kırmızı 22mm Kesintili Çalışmalı 230V AC	593391	48,43	10
ND-16F Kırmızı 22mm Kesintili Çalışmalı 24 V AC/DC	593381	48,43	10



NP2 Serisi 22mm Metal Seri Buton ve Sinyal Lambası

AC/DC korumalı LED grubu

	Ürün Tanımı 220/380 V AC	Kontakt	Renk	Sipariş Kodu	Birim Fiyat (₺)	Kutu Adeti
	Yaylı Buton	1NA	Beyaz	573954	28,18	10
		1NA	Siyah	573955	28,18	10
		1NA	Yeşil	573956	28,18	10
		1NA	Sarı	573959	28,18	10
		1NA	Mavi	573892	28,18	10
		1NK	Kırmızı	573890	28,18	10
	40mm Mantar	1NA	Siyah	573969	42,37	10
	Acil Stop Butonu 40 mm	1NK	Kırmızı	573894	47,75	10
	İkiz Buton	Start/Stop	Yeşil+Kırmızı	574004	51,41	10
		Start/Stop/Işıklı LED'li 24 V	Yeşil+Kırmızı	574368	84,47	10
		Start/Stop/Işıklı LED'li 220V	Yeşil+Kırmızı	574909	84,47	10
	Işıklı yaylı Buton, LED'li 24 VAC	1NA+1NK	Beyaz	574337	58,77	10
		1NA+1NK	Yeşil	574340	58,77	10
		1NA+1NK	Kırmızı	574343	58,77	10
		1NA+1NK	Sarı	574346	58,77	10
		1NA+1NK	Mavi	574349	58,77	10
	Işıklı Yaylı Buton, LED'li 220 V AC/DC	1NA+1NK	Beyaz	574364	58,77	10
		1NA+1NK	Yeşil	575642	58,77	10
		1NA+1NK	Kırmızı	575643	58,77	10
		1NA+1NK	Sarı	575647	58,77	10
		1NA+1NK	Mavi	574367	58,77	10
	Plastik Korumalı, Yaylı Buton	1NA	Siyah	575875	31,58	10
		1NA	Yeşil	575876	31,58	10
		1NA	Sarı	575877	31,58	10
		1NK	Kırmızı	575878	31,58	10
	Mandal Buton	2 Konum Kalıcı	Siyah	573977	33,04	10
		3 Konum Kalıcı	Siyah	574658	44,07	10
		3 Konum geriye Yaylı	Siyah	574659	47,75	10
	Uzun Mandal Buton	2 Konum Kalıcı	Siyah	573992	33,04	10
		3 Konum Kalıcı	Siyah	574209	47,75	10
		3 Konum geriye Yaylı	Siyah	574653	51,41	10
	Kilit Buton	2 Konumlu	Siyah	573986	58,77	10
		3 Konumlu, Kilit Her Yönde	Siyah	574657	73,45	10
		3 Konumlu, Kilit Ortada	Siyah	574654	73,45	10
	Sinyal Lambası, LED'li 220 V AC/DC		Beyaz	574386	36,68	10
			Yeşil	574048	36,68	10
			Kırmızı	574049	36,68	10
			Sarı	574050	36,68	10
			Mavi	575623	36,68	10
	Sinyal Lambası, LED'li 24 V AC/DC		Beyaz	574331	36,68	10
			Yeşil	574045	36,68	10
			Kırmızı	574046	36,68	10
			Sarı	574047	36,68	10
			Mavi	575218	36,68	10



NP2 Serisi 22mm Plastik Seri Buton ve Sinyal Lambası

AC/DC korumalı LED grubu



	Ürün Tanımı 220/380 V AC	Kontakt	Renk	Sipariş Kodu	Birim Fiyat (₺)	Kutu Adeti
Yaylı Buton		1NA	Beyaz	574576	18,74	10
		1NA	Siyah	574084	18,74	10
		1NA	Yeşil	574085	18,74	10
		1NA	Sarı	574086	18,74	10
		1NA	Mavi	574087	18,74	10
		1NK	Kırmızı	574628	18,74	10
	40mm Mantar	1 NK	Siyah	574092	28,17	10
Acil Stop Butonu 40 mm	Acil Stop Butonu 40 mm	1NK	Kırmızı	574120	33,22	10
İkiz Buton	Start/Stop	1NA+1NK	Yeşil+Kırmızı	575281	36,74	10
	Start/Stop/Işıklı LED'li 24 V	1NA+1NK	Yeşil+Kırmızı	575439	66,10	10
	Start/Stop/Işıklı LED'li 220V	1NA+1NK	Yeşil+Kırmızı	575343	66,10	10
Işıklı yaylı Buton, LED'li 24 VAC/DC		1NA+1NK	Beyaz	575306	53,28	10
		1NA+1NK	Yeşil	575316	53,28	10
		1NA+1NK	Kırmızı	575330	53,28	10
		1NA+1NK	Sarı	575336	53,28	10
		1NA+1NK	Mavi	575342	53,28	10
Işıklı Yaylı Buton, LED'li 220 V AC/DC		1NA+1NK	Beyaz	575644	53,28	10
		1NA+1NK	Yeşil	574164	53,28	10
		1NA+1NK	Kırmızı	575645	53,28	10
		1NA+1NK	Sarı	574163	53,28	10
		1NA+1NK	Mavi	575447	53,28	10
Mandal Buton	2 Konum Kalıcı	1NA	Siyah	574095	29,38	10
	3 Konum Kalıcı	1NA+1NK	Siyah	575423	40,40	10
	3 Konum geriye Yaylı	1NA+1NK	Siyah	575558	44,07	10
Uzun Mandal Buton	2 Konum Kalıcı	1NA	Siyah	574108	29,38	10
	3 Konum Kalıcı	1NA+1NK	Siyah	575424	40,40	10
	3 Konum geriye Yaylı	1NA+1NK	Siyah	576025	44,07	10
Kilit Buton	2 Konumlu	1NA	Siyah	574102	47,75	10
	3 Konumlu, Kilit her Yönde.	1NA+1NK	Siyah	575964	58,77	10
	3 Konumlu, Kilit Ortada	1NA+1NK	Siyah	576027	58,77	10
Sinyal Lambası, LED'li 220 V AC/DC			Beyaz	574798	29,38	10
			Yeşil	574582	29,38	10
			Kırmızı	574583	29,38	10
			Sarı	574668	29,38	10
			Mavi	574683	29,38	10
Sinyal Lambası, LED'li 24 V AC/DC			Beyaz	575296	29,38	10
			Yeşil	574629	29,38	10
			Kırmızı	574142	29,38	10
			Sarı	575299	29,38	10
			Mavi	575300	29,38	10

NP2 Serisi Butonlar için Yardımcı Aksesuarlar

Ürün Tanımı 220/380 V AC	Kontakt	Renk	Sipariş Kodu	Birim Fiyat (₺)	Kutu Adeti
İlave Kontakt	1NA		576841	18,37	50
İlave Kontakt	1NK		576842	18,37	50
Pano Etiketi			576794	3,66	80
Sarı Renk Dairesel Etiket (Acil Durdurma)			576785	6,24	80



NP8 Serisi 22mm Krom Gövde Seri Buton ve Sinyal Lambası





	Ürün Tanımı 220/380 V AC	Kontak	Renk	Sipariş Kodu	Birim Fiyat (₺)	Kutu Adeti	
	Yaylı Buton	1NA	Beyaz	578646	44,07	10	
		1NA	Siyah	578647	44,07	10	
		1NA	Yeşil	667232	44,07	10	
		1NA	Sarı	667333	44,07	10	
		1NA	Mavi	578645	44,07	10	
		1NK	Kırmızı	667231	44,07	10	
		40mm Mantar	1NA	Siyah	578935	55,08	10
	Acil Stop Butonu 40 mm	1NK	Kırmızı	667210	66,10	10	
	İkiz Buton	Start/Stop	1NA+1NK	Yeşil+Kırmızı	667178	73,45	10
		Start/Stop/Işıklı LED'li 24 VAC/DC & 220 VAC	1NA+1NK	Yeşil+Kırmızı	667173	154,50	10
	Işıklı Yaylı Buton, LED'li 24 VAC/ DC & 220 VAC	1NA	Beyaz	578662	91,82	10	
		1NA	Yeşil	667251	91,82	10	
		1NA	Kırmızı	667252	91,82	10	
		1NA	Sarı	667321	91,82	10	
		1NA	Mavi	578663	91,82	10	
	Mandal Buton	2 Konum Kalıcı	1NA	Siyah	578661	58,77	10
		3 Konum Kalıcı	1NA+1NK	Siyah	667137	84,47	10
	Işıklı Mandal Buton, 2 Konum Kalıcı 24VAC/DC & 220VAC	1NA+1NK	Yeşil	667149	136,10	10	
		1NA+1NK	Kırmızı	667150	136,10	10	
		1NA+1NK	Sarı	667151	136,10	10	
	Işıklı Mandal Buton, 3 Konum Kalıcı 24VAC/DC & 220VAC	1NA+1NK	Yeşil	667161	147,10	10	
		1NA+1NK	Kırmızı	667162	147,10	10	
		1NA+1NK	Sarı	667163	147,10	10	
	Kilit Buton	2 Konumlu	1NA	578130	62,44	10	
		3 Konumlu, Kilit her Yönde.	1NA+1NK	667183	95,48	10	
	Sinyal Lambası, LED'li 24 VAC/DC & 220 VAC		Beyaz	578991	84,47	10	
			Yeşil	667107	84,47	10	
			Kırmızı	667108	84,47	10	
			Sarı	578651	84,47	10	
			Mavi	578642	84,47	10	













Siparişte Sinyal Lambası Gerilim Seviyesi mutlaka bildirilmelidir.
24V, 48V, 110V, 220V AC
24V, 48V, 110V, 220V DC



NP2 Kutular

Esnek Çözüm

	Sipariş Kodu	Birim Fiyat (₺)
	573891	52,38
	575576	71,09
	575577	86,05
	575575	86,05
	573927	112,30
	573928	112,30
	573929	112,30
	573930	112,30
	573931	112,30
	573933	112,30
	574878	127,40
	573937	127,40
	573936	127,40

	Sipariş Kodu	Birim Fiyat (₺)
	574165	127,40
	574166	127,40
	573938	157,40
	573939	157,40
	573940	157,40
	573941	193,20
	573945	193,20
	573946	193,20
	573947	193,20
	573949	193,20
	573944	193,20
	573950	193,20





Zaman Röleleri | Elektronik | DIN Ray Tip



Ürün Tanımı	Zaman Aralığı	Uygulama		Teknik Özellikler								Çalışma Gerilimi			Sipariş Kodu	Birim Fiyat (₺)
		Kademe Sayısı	Ray Tipi / İnce (22,5)	Çekmede Gecikmeli (Delay ON)	Brakmada Gecikmeli (Delay OFF)	Çift Zaman Ayarı	Yıldız - Üçgen	Simetrik Flaşör	Tetiklemeli	Açık Flaşör (ON)	Kapalı Flaşör (OFF)	24 V AC/DC	220V AC	Universal 24-220 VAC/DC 12 VAC/DC		
DN-T01 Zaman Rölesi	0,1 - 30 sn		●	●	●							●	●		500308	125,00
DN-T02 Zaman Rölesi	0,1 sn - 60 sn		●	●	●	●						●	●		500309	125,00
DN-T03 Çok Fonksiyonlu Zaman Rölesi	0,06 sn - 30 saat	7	●	●	●	●				●	●	●	●		500310	155,90
DN-T04 Çok Fonksiyonlu Zaman Rölesi	0,6 sn - 10 saat	6	●						●		●	●	●		500311	155,90
DN-T05 Çok Fonksiyonlu Zaman Rölesi	0,05 - 100 saat	7	●	●	●				●	●	●			●	500312	180,00
DN-SD Yıldız-Üçgen Rölesi	Y: 3 sec -30 sec Y→Δ:50...500msec.		●					●	●				●		500313	245,80

Gerilim Koruma Röleleri | Elektronik | DIN Ray Tip



Ürün Tanımı	Uygulama		Teknik Özellikler										Çalışma Gerilimi	Sipariş Kodu	Birim Fiyat (₺)
	Ray Tipi / İnce (22,5)	Ray Tipi / Normal (35)	Led Göstergeli Ekran	Tek Faz	3 Faz	Aşırı Gerilim Ani Açma (Un*1,5)	Düşük Gerilim Ani Açma (Un*0,5)	Faz Sırası	Faz Yokluğu	Çekme Gecikmesi (t-on)	Açma/Bırakma Gecikmesi (t-off)	220 Vac ± % 35			
DN-VP01 Gerilim Koruma Rölesi		●	●	●		●	●		●	X (1 sn. - 20 sn.)	X (1 sn. - 20 sn.)	●	500314	220,00	
DN-VP02 Gerilim Koruma Rölesi	●		●	●		●	●		●		X (1 sn. - 20 sn.)	●	500315	220,00	
DN-VP03 Gerilim Koruma Rölesi	●		●		●	●	●	●			X (1 sn. - 20 sn.)	●	500316	220,00	
DN-VP04 Gerilim Koruma Rölesi	●		●	●		●	●		●	X (3 dk.)	X (0,1 sn. - 20 sn.)	●	500317	220,00	
DN-VP05 Gerilim Koruma Rölesi	●		●		●	●	●	●	●	X (3 dk.)	X (0,1 sn. - 20 sn.)	●	500318	220,00	

Motor (Faz) Koruma Röleleri | Elektronik | DIN Ray Tip

Ürün Tanımı	Uygulama		Ölçüm ve Teknik Özellikler							Besleme	Sipariş Kodu	Birim Fiyat (₺)
	Ray Tipi / İnce (22,5)	Manuel Gösterge Ekran	Nötr Kopması Algılaması	Faz Sırası Korunmalı	Asimetri Ayarlı	Asimetre Aralığı	Faz - Faz	Faz - Nötr	Açma/Bırakma Gecikmesi (t-off)			
DN-MP01 Motor (Faz) Koruma Rölesi	●	●	●			30%		●		●	500319	150,00
DN-MP02 Motor (Faz) Koruma Rölesi	●	●	●	●	●	%5 - %15	●		X (0,1 sn. - 10 sn.)	●	500320	190,00
DN-M03 Motor(Faz) Koruma Rölesi	●	●				30%		●		●	500392	147,00
DN-M04 Motor(Faz) Koruma Rölesi	●	●		●	●	%10 - % 30		●		●	500552	150,00

Hidrofor Sıralama Rölesi | Elektronik | DIN Ray Tip

	Uygulama		Ölçüm ve Teknik Özellikler		Kutu Adeti	Sipariş Kodu	Birim Fiyat (₺)
	Ray Tipi / İnce (22,5)		2 Basınç Şalter Girişi	2 Hidrofor Çıkışı			
DN-H01 Hidrofor Sıralama Rölesi	●		●	●	10	500401	239,00

Fotosel Rölesi | Elektronik | DIN Ray Tip



	Uygulama		Ölçüm ve Teknik Özellikler			Kutu Adeti	Sipariş Kodu	Birim Fiyat (₺)
	Ray Tipi / İnce (22,5)		1-10 Lux Ayarlı	Röle Çıkışı	Fotosel Göz Dahil			
DN-F01 Fotosel Rölesi	●		●	●	●	10	500536	200,00

Sıvı Seviye Kontrol Röleleri | Elektronik | DIN Ray Tip



Ürün Tanımı	Uygulama		Ölçüm ve Teknik Özellikler			Besleme	Sipariş Kodu	Birim Fiyat (₺)
	Ray Tipi / İnce (22,5)	Led Göstergeli	2-100 kΩ İletkenlik Ayarı	Boy: 150 mm Ø: 26 mm	Boy: 90 mm Ø: 19 mm	220 VAC ± %20 (L-N)		
DN-L01 Sıvı Seviye Kontrol Rölesi	●	●	●				500321	165,00
SE-L01 Küçük Elektrod					●		500322	24,00
BE-L01 Büyük Elektrod				●			500323	32,00

YENİ CDM Serisi Dijital Multimetreler



Ürün Tanımı	Boyutlar		Uygulama ve Teknik Özellikler							Besleme	Sipariş Kodu	Birim Fiyat (₺)	
	96x96mm	İzole	Uygulama Alçak Gerilim	LED EKCRAN	3* Voltmetre	3* Ampermetre	3* Frekansmetre	Hz	TRUE RMS	SINIF (CLASS)			Besleme Gerilimi
CDM-01 İzolesiz Dijital Multimetre	●		●	●	●	●	●	●	220 Vac ± %20	0,5	●	500537	565,70
CDM-02 İzoleli Dijital Multimetre	●	●	●	●	●	●	●	●	220 Vac ± %20	0,5	●	500538	662,90



0-1 Aç/Kapa Pako Şalterler

Kod Detayı				
Ürün serisi	Kutup sayısı	Akım	Tip	Model
CSL	*P	***A	01: Aç/kapa tip	S : Emniyet- sarı kırmızı kilitleli çerçeve
			02: 1-0-2 kutup değiştirici tip	Boş: -

Ürün Tanımı	Faz/Kutup Sayısı	Nominal Akım(A)	Sipariş Kodu	Birim Fiyat (₺)
CSL-1P010A01	1	10	500370	44,02
CSL-1P016A01	1	16	500371	51,70
CSL-1P025A01	1	25	500372	62,88
CSL-1P040A01	1	40	500373	87,62
CSL-1P063A01	1	63	500374	102,60
CSL-1P080A01	1	80	500375	115,10
CSL-2P010A01	2	10	500376	58,41
CSL-2P016A01	2	16	500377	64,83
CSL-2P025A01	2	25	500378	76,02
CSL-2P040A01	2	40	500379	116,90
CSL-2P063A01	2	63	500380	137,00
CSL-2P080A01	2	80	500381	166,10
CSL-3P010A01	3	10	500382	69,72
CSL-3P016A01	3	16	500383	78,53
CSL-3P025A01	3	25	500384	91,53
CSL-3P040A01	3	40	500385	140,40
CSL-3P063A01	3	63	500386	164,20
CSL-3P080A01	3	80	500132	227,70
CSL-4P010A01	4	10	500133	102,30
CSL-4P016A01	4	16	500134	111,10
CSL-4P025A01	4	25	500135	131,60
CSL-4P040A01	4	40	500136	196,00
CSL-4P063A01	4	63	500137	210,50
CSL-4P080A01	4	80	500138	280,90
CSL-5P010A01	5	10	500139	105,30
CSL-5P016A01	5	16	500140	113,90
CSL-5P025A01	5	25	500141	138,80
CSL-5P040A01	5	40	500142	210,50
CSL-5P063A01	5	63	500143	243,20
CSL-5P080A01	5	80	500144	370,40
CSL-6P010A01	6	10	500145	116,90
CSL-6P016A01	6	16	500146	124,80
CSL-6P025A01	6	25	500147	147,60
CSL-6P040A01	6	40	500148	255,40
CSL-6P063A01	6	63	500149	312,20
CSL-6P080A01	6	80	500150	441,90

* 80A ve üzeri talepleriniz için üretim yapılabilir.

* Her tip pako şalter için uygun kutu mevcuttur.





Emniyet Tip Aç-Kapa Pako Şalterler



Ürün Tanımı	Faz/Kutup Sayısı	Nominal Akım(A)	Sipariş Kodu	Birim Fiyat (₺)
CSL-1P010A01S	1	10	500151	44,02
CSL-1P016A01S	1	16	500152	51,70
CSL-1P025A01S	1	25	500153	62,88
CSL-1P040A01S	1	40	500154	87,62
CSL-1P063A01S	1	63	500155	102,60
CSL-1P080A01S	1	80	500156	115,10
CSL-2P010A01S	2	10	500157	58,41
CSL-2P016A01S	2	16	500158	64,83
CSL-2P025A01S	2	25	500159	76,02
CSL-2P040A01S	2	40	500160	116,90
CSL-2P063A01S	2	63	500161	137,00
CSL-2P080A01S	2	80	500162	166,10
CSL-3P010A01S	3	10	500163	69,72
CSL-3P016A01S	3	16	500164	78,53
CSL-3P025A01S	3	25	500165	91,53
CSL-3P040A01S	3	40	500166	140,40
CSL-3P063A01S	3	63	500167	164,20
CSL-3P080A01S	3	80	500168	227,70
CSL-4P010A01S	4	10	500169	102,30
CSL-4P016A01S	4	16	500170	111,10
CSL-4P025A01S	4	25	500171	131,60
CSL-4P040A01S	4	40	500172	196,00
CSL-4P063A01S	4	63	500173	210,50
CSL-4P080A01S	4	80	500174	280,90
CSL-5P010A01S	5	10	500175	105,30
CSL-5P016A01S	5	16	500176	113,90
CSL-5P025A01S	5	25	500177	138,80
CSL-5P040A01S	5	40	500178	210,50
CSL-5P063A01S	5	63	500179	243,20
CSL-5P080A01S	5	80	500180	370,40
CSL-6P010A01S	6	10	500305	116,90
CSL-6P016A01S	6	16	500306	124,80
CSL-6P025A01S	6	25	500307	147,60
CSL-6P040A01S	6	40	500181	255,40
CSL-6P063A01S	6	63	500182	312,20
CSL-6P080A01S	6	80	500183	441,90

* 80A ve üzeri talepleriniz için üretim yapılabilir.

* Her tip pako şalter için uygun kutu mevcuttur.



1 - 0 - 2 Kademeli / Kutup Değişirici Pako Şalterler



Ürün Tanımı	Faz/Kutup Sayısı	Nominal Akım(A)	Sipariş Kodu	Birim Fiyat (₺)
CSL-1P010A02	1	10	500184	60,78
CSL-1P016A02	1	16	500185	66,79
CSL-1P025A02	1	25	500186	88,17
CSL-1P032A02	1	32	500187	109,50
CSL-1P040A02	1	40	500188	134,60
CSL-1P063A02	1	63	500189	173,30
CSL-1P080A02	1	80	500190	212,80
CSL-2P010A02	2	10	500191	87,62
CSL-2P016A02	2	16	500192	102,30
CSL-2P025A02	2	25	500193	116,90
CSL-2P040A02	2	40	500194	169,80
CSL-2P063A02	2	63	500195	203,50
CSL-2P080A02	2	80	500196	295,50
CSL-3P010A02	3	10	500197	108,20
CSL-3P016A02	3	16	500198	121,70
CSL-3P025A02	3	25	500199	146,10
CSL-3P032A02	3	32	500200	192,40
CSL-3P040A02	3	40	500201	246,30
CSL-3P063A02	3	63	500202	285,70

* İstenildiği takdirde diğer Amper talepli kutup deęiřtiriciler de üretilebilir.

* İstenildiği takdirde "1 - 2" kademeli şalterlerde üretilebilir.

* Her tip pako şalter için uygun kutu mevcuttur.



CSL Serisi Kademeli Şalterler

Ürün Tanımı	Faz/Kutup Sayısı	Pozisyon	Nominal Akım(A)	Sipariş Kodu	Birim Fiyat (₺)
CSL-1P010A032	1	0-1-2	10	500456	59,78
CSL-1P016A032	1	0-1-2	16	500457	71,74
CSL-1P025A032	1	0-1-2	25	500459	86,68
CSL-1P040A032	1	0-1-2	40	500460	113,60
CSL-1P063A032	1	0-1-2	63	500461	125,70
CSL-1P080A032	1	0-1-2	80	500462	146,50
CSL-1P010A033	1	0-1-2-3	10	500388	80,71
CSL-1P016A033	1	0-1-2-3	16	500463	86,68
CSL-1P025A033	1	0-1-2-3	25	500465	98,64
CSL-1P040A033	1	0-1-2-3	40	500466	131,60
CSL-1P063A033	1	0-1-2-3	63	500467	173,40
CSL-1P080A033	1	0-1-2-3	80	500468	200,30
CSL-1P010A034	1	0-1-2-3-4	10	500389	89,67
CSL-1P016A034	1	0-1-2-3-4	16	500469	104,70
CSL-1P025A034	1	0-1-2-3-4	25	500471	122,60
CSL-1P040A034	1	0-1-2-3-4	40	500472	170,50
CSL-1P063A034	1	0-1-2-3-4	63	500473	236,30
CSL-1P080A034	1	0-1-2-3-4	80	500474	248,20
CSL-1P010A035	1	0-1-2-3-4-5	10	500390	92,65
CSL-1P016A035	1	0-1-2-3-4-5	16	500475	113,60
CSL-1P025A035	1	0-1-2-3-4-5	25	500477	131,90
CSL-1P040A035	1	0-1-2-3-4-5	40	500478	209,40
CSL-1P063A035	1	0-1-2-3-4-5	63	500479	239,20
CSL-1P080A035	1	0-1-2-3-4-5	80	500480	266,10
CSL-1P010A036	1	0-1-2-3-4-5-6	10	500391	97,47
CSL-1P016A036	1	0-1-2-3-4-5-6	16	500482	119,60
CSL-1P025A036	1	0-1-2-3-4-5-6	25	500484	164,60
CSL-1P040A036	1	0-1-2-3-4-5-6	40	500485	242,20
CSL-1P063A036	1	0-1-2-3-4-5-6	63	500486	275,10
CSL-1P080A036	1	0-1-2-3-4-5-6	80	500487	352,80
CSL-1P010A037	1	0-1-2-3-4-5-6-7	10	500488	107,70
CSL-1P016A037	1	0-1-2-3-4-5-6-7	16	500489	125,70
CSL-1P025A037	1	0-1-2-3-4-5-6-7	25	500491	176,40
CSL-1P040A037	1	0-1-2-3-4-5-6-7	40	500492	264,80
CSL-1P063A037	1	0-1-2-3-4-5-6-7	63	500493	290,10
CSL-1P080A037	1	0-1-2-3-4-5-6-7	80	500494	379,70



CSL Serisi 7 Pozisyon Voltmetre Şalteri

Ürün Tanımı	Faz/Kutup Sayısı	Pozisyon	Nominal Akım(A)	Sipariş Kodu	Birim Fiyat (₺)
CSL-3P010A07V	3	0-L1N-L2N-L3N-L1L2-L2L3-L1L3	10	500395	102,90
CSL-3P016A07V	3	0-L1N-L2N-L3N-L1L2-L2L3-L1L3	16	500495	119,60
CSL-3P020A07V	3	0-L1N-L2N-L3N-L1L2-L2L3-L1L3	20	500496	143,60





CSX Serisi 0-1 Aç/Kapa Pako Şalterler

Kod Detayı				
Ürün serisi	Kutup sayısı	Akım	Tip	Model
CSX	*P	***A	01: Aç/kapa tip	M:-
			02: 1-0-2 kutup değiştirici tip	TR:-
				SM:Emniyet- sarı kırmızı kilitli çerçeve
				STR:Emniyet- sarı kırmızı kilitli çerçeve

Ürün Tanımı	Faz/Kutup Sayısı	Nominal Akım(A)	Sipariş Kodu	Birim Fiyat (₺)
CSX-1P010A01M	1	10	500203	51,28
CSX-1P016A01M	1	16	500204	60,37
CSX-1P020A01M	1	20	500205	63,44
CSX-1P025A01M	1	25	500206	83,84
CSX-1P040A01M	1	40	500207	116,70
CSX-1P063A01TR	1	63	500208	140,20
CSX-1P080A01TR	1	80	500209	184,20
CSX-2P010A01M	2	10	500210	64,42
CSX-2P016A01M	2	16	500211	78,68
CSX-2P020A01M	2	20	500212	81,75
CSX-2P025A01M	2	25	500213	106,00
CSX-2P040A01M	2	40	500214	142,10
CSX-2P063A01TR	2	63	500215	181,20
CSX-2P080A01TR	2	80	500216	245,50
CSX-3P010A01M	3	10	500217	78,68
CSX-3P016A01M	3	16	500218	96,13
CSX-3P020A01M	3	20	500219	105,00
CSX-3P025A01M	3	25	500220	128,20
CSX-3P040A01M	3	40	500221	191,30
CSX-3P063A01TR	3	63	500222	252,40
CSX-3P080A01TR	3	80	500223	306,70
CSX-4P010A01M	4	10	500224	111,30
CSX-4P016A01M	4	16	500225	122,40
CSX-4P020A01M	4	20	500226	127,80
CSX-4P025A01M	4	25	500227	151,40
CSX-4P040A01M	4	40	500228	215,60
CSX-4P063A01TR	4	63	500229	294,50
CSX-4P080A01TR	4	80	500230	379,40
CSX-5P010A01M	5	10	500231	153,50
CSX-5P016A01M	5	16	500232	154,30
CSX-5P020A01M	5	20	500233	159,80
CSX-5P025A01M	5	25	500234	185,30
CSX-5P040A01M	5	40	500235	282,00
CSX-5P063A01TR	5	63	500236	339,00
CSX-5P080A01TR	5	80	500237	411,60
CSX-6P010A01M	6	10	500238	163,10
CSX-6P016A01M	6	16	500239	167,70
CSX-6P020A01M	6	20	500240	173,90
CSX-6P025A01M	6	25	500241	188,90
CSX-6P040A01M	6	40	500242	302,30
CSX-6P063A01TR	6	63	500243	359,50
CSX-6P080A01TR	6	80	500244	526,70





Emniyet Tip Aç-Kapa Pako Şalterler



Ürün Tanımı	Faz/Kutup Sayısı	Nominal Akım(A)	Sipariş Kodu	Birim Fiyat (₺)
CSX-1P010A01SM	1	10	500245	51,28
CSX-1P016A01SM	1	16	500246	60,37
CSX-1P020A01SM	1	20	500247	63,44
CSX-1P025A01SM	1	25	500248	83,84
CSX-1P040A01SM	1	40	500249	116,70
CSX-1P063A01STR	1	63	500250	140,20
CSX-1P080A01STR	1	80	500251	184,20
CSX-2P010A01SM	2	10	500252	66,93
CSX-2P016A01SM	2	16	500253	78,68
CSX-2P020A01SM	2	20	500254	81,75
CSX-2P025A01SM	2	25	500255	106,00
CSX-2P040A01SM	2	40	500256	142,10
CSX-2P063A01STR	2	63	500257	181,20
CSX-2P080A01STR	2	80	500258	245,50
CSX-3P010A01SM	3	10	500259	78,68
CSX-3P016A01SM	3	16	500260	96,13
CSX-3P020A01SM	3	20	500261	105,00
CSX-3P025A01SM	3	25	500262	128,20
CSX-3P040A01SM	3	40	500263	191,30
CSX-3P063A01STR	3	63	500264	252,40
CSX-3P080A01STR	3	80	500265	306,70
CSX-4P010A01SM	4	10	500266	121,60
CSX-4P016A01SM	4	16	500267	132,40
CSX-4P020A01SM	4	20	500268	137,80
CSX-4P025A01SM	4	25	500269	156,10
CSX-4P040A01SM	4	40	500270	233,60
CSX-4P063A01STR	4	63	500271	294,50
CSX-4P080A01STR	4	80	500272	379,40
CSX-5P010A01SM	5	10	500273	153,50
CSX-5P016A01SM	5	16	500274	154,30
CSX-5P020A01SM	5	20	500275	159,80
CSX-5P025A01SM	5	25	500276	185,30
CSX-5P040A01SM	5	40	500277	282,00
CSX-5P063A01STR	5	63	500278	339,00
CSX-5P080A01STR	5	80	500279	411,60
CSX-6P010A01SM	6	10	500280	163,10
CSX-6P016A01SM	6	16	500281	167,70
CSX-6P020A01SM	6	20	500282	173,90
CSX-6P025A01SM	6	25	500283	188,90
CSX-6P040A01SM	6	40	500284	302,30
CSX-6P063A01STR	6	63	500285	359,50
CSX-6P080A01STR	6	80	500286	526,70

* 80A ve üzeri talepleriniz için üretim yapılabilir.

* Her tip pako şalter için uygun kutu mevcuttur.



1 - 0 - 2 Kademeli / Kutup Değiştirici Pako Şalterler



Ürün Tanımı	Faz/Kutup Sayısı	Nominal Akım(A)	Sipariş Kodu	Birim Fiyat (₺)
CSX-1P010A02M	1	10	500287	70,70
CSX-1P016A02M	1	16	500288	73,63
CSX-1P020A02M	1	20	500289	82,73
CSX-1P025A02M	1	25	500290	111,70
CSX-1P040A02M	1	40	500291	153,50
CSX-1P063A02TR	1	63	500292	195,00
CSX-1P080A02TR	1	80	500293	302,90
CSX-2P010A02M	2	10	500294	107,40
CSX-2P016A02M	2	16	500295	116,70
CSX-2P020A02M	2	20	500296	126,50
CSX-2P025A02M	2	25	500297	155,10
CSX-2P040A02M	2	40	500298	228,70
CSX-2P063A02TR	2	63	500299	290,40
CSX-2P080A02TR	2	80	500300	453,00
CSX-3P010A02M	3	10	500301	118,70
CSX-3P025A02M	3	25	500302	216,40
CSX-3P040A02M	3	40	500303	309,70
CSX-3P063A02TR	3	63	500304	404,50

* İstenildiği takdirde diğer Amper talepli kutup değiştiriciler de üretilebilir.

* İstenildiği takdirde "1 - 2" kademeli şalterlerde üretilebilir.

* Her tip pako şalter için uygun kutu mevcuttur.



CSX Serisi Kademeli Şalterler

Ürün Tanımı	Faz/Kutup Sayısı	Pozisyon	Nominal Akım(A)	Sipariş Kodu	Birim Fiyat (₺)
CSX-1P010A032M	1	0-1-2	10	500414	87,64
CSX-1P016A032M	1	0-1-2	16	500415	88,90
CSX-1P020A032M	1	0-1-2	20	500416	91,45
CSX-1P025A032M	1	0-1-2	25	500417	111,80
CSX-1P040A032M	1	0-1-2	40	500418	151,10
CSX-1P063A032STR	1	0-1-2	63	500419	245,50
CSX-1P080A032STR	1	0-1-2	80	500420	289,80
CSX-1P010A033M	1	0-1-2-3	10	500421	100,60
CSX-1P016A033M	1	0-1-2-3	16	500422	111,10
CSX-1P020A033M	1	0-1-2-3	20	500423	126,70
CSX-1P025A033M	1	0-1-2-3	25	500424	148,00
CSX-1P040A033M	1	0-1-2-3	40	500425	194,90
CSX-1P063A033STR	1	0-1-2-3	63	500426	283,70
CSX-1P080A033STR	1	0-1-2-3	80	500427	355,70
CSX-1P010A034M	1	0-1-2-3-4	10	500428	112,50
CSX-1P016A034M	1	0-1-2-3-4	16	500429	130,10
CSX-1P020A034M	1	0-1-2-3-4	20	500430	156,90
CSX-1P025A034M	1	0-1-2-3-4	25	500431	166,90
CSX-1P040A034M	1	0-1-2-3-4	40	500432	244,10
CSX-1P063A034STR	1	0-1-2-3-4	63	500433	317,40
CSX-1P080A034STR	1	0-1-2-3-4	80	500434	373,30
CSX-1P010A035M	1	0-1-2-3-4-5	10	500435	139,80
CSX-1P016A035M	1	0-1-2-3-4-5	16	500436	146,20
CSX-1P020A035M	1	0-1-2-3-4-5	20	500437	168,20
CSX-1P025A035M	1	0-1-2-3-4-5	25	500438	212,80
CSX-1P040A035M	1	0-1-2-3-4-5	40	500439	285,80
CSX-1P063A035STR	1	0-1-2-3-4-5	63	500440	380,70
CSX-1P080A035STR	1	0-1-2-3-4-5	80	500441	419,70
CSX-1P010A036M	1	0-1-2-3-4-5-6	10	500442	150,10
CSX-1P016A036M	1	0-1-2-3-4-5-6	16	500443	163,80
CSX-1P020A036M	1	0-1-2-3-4-5-6	20	500444	181,30
CSX-1P025A036M	1	0-1-2-3-4-5-6	25	500445	226,70
CSX-1P040A036M	1	0-1-2-3-4-5-6	40	500446	359,70
CSX-1P063A036STR	1	0-1-2-3-4-5-6	63	500447	501,60
CSX-1P080A036STR	1	0-1-2-3-4-5-6	80	500448	615,60
CSX-1P010A037M	1	0-1-2-3-4-5-6-7	10	500449	175,40
CSX-1P016A037M	1	0-1-2-3-4-5-6-7	16	500450	178,30
CSX-1P020A037M	1	0-1-2-3-4-5-6-7	20	500451	211,70
CSX-1P025A037M	1	0-1-2-3-4-5-6-7	25	500452	266,00
CSX-1P040A037M	1	0-1-2-3-4-5-6-7	40	500453	352,50
CSX-1P063A037STR	1	0-1-2-3-4-5-6-7	63	500454	495,40
CSX-1P080A037STR	1	0-1-2-3-4-5-6-7	80	500455	690,20



CSX Serisi 7 Pozisyon Voltmetre Şalteri

Ürün Tanımı	Faz/Kutup Sayısı	Pozisyon	Nominal Akım(A)	Sipariş Kodu	Birim Fiyat (₺)
CSX-3P010A07V	3	0-L1N-L2N-L3N-L1L2-L2L3-L1L3	10	500497	141,50
CSX-3P016A07V	3	0-L1N-L2N-L3N-L1L2-L2L3-L1L3	16	500498	147,90
CSX-3P020A07V	3	0-L1N-L2N-L3N-L1L2-L2L3-L1L3	20	500499	152,80



CHINT

CHINT GLOBAL

Elektriğin kontrolü sizde!

Her durumda, maksimum koruma.

Chint, 36 yıllık deneyimiyle ürettiği otomatik sigortalar, kaçak akım koruma ürünleri ve parafudrlar ile evden fabrikaya tüm yapılarda güvenilir koruma sağlar.

3 Yıl
Garanti



Zengin yardımcı
aksesuar desteği



Teknik servis ve
destek hizmeti



Geniş ürün yelpazesi ile
eksiksiz ürün portföyü



Zorlu çevre
koşullarında sorunsuz
ve güvenilir çalışma



Montaj ve bakımı kolay
ergonomik tasarım



Otomatik Sigortalar

Kaçak Akım Röleleri

Parafudrlar



+90 216 621 00 55
www.chint.com.tr

CHINT

CHINT GLOBAL

Sosyal Medya'da Bizi Takip Edin!



@chintturkiye



@Chintgroupturca



@chintturkiye



CHINT TURCA ELEKTRİK SANAYİ ve TİCARET A. Ş.

Zümrütevler Mah. Ural Sok. No:22 Nas Plaza Kat: 1 No:18-19 Maltepe - İstanbul - Türkiye

+90 216 621 00 55 / +90 216 621 00 50

satis@chint.com.tr



Önemli Not: CHINT önceden haber vermezseniz başka kişilerle yapma veya bu dokümanı şirket dışına dağıtma hakkına sahip olabilirsiniz. Sözlerine ayarlanmaz, üstünde koruyucu anahtarlar yerleştirilmiştir. CHINT, bu dokümanı için haberler veya diğer bilgiler için herhangi bir sorumluluk kabul etmemektedir. Bu dokümanı ve ilgili konuları burada bulunan herkesin bilgi hakkı vardır, CHINT'ın yazık ziri olamazsınız. Her hakkı koruyulmuş. Üçüncü kişiler kullanımı veya dağıtımını yasaklamıştır.