



FİYAT LİSTESİ
PRICE LIST

37
years
Since 1983

20
20

mutlusan.com.tr

Ritā	2
Elitra Plus	8
Candelā	13
BRON	19
Nemliyer	21
Grup Prizler	23
Aksesuarlar	27

tesisat grubu

Comfort w otomat kutuları	30
Comfort zayıf akım kutuları	30
Meksbox w otomat kutuları	31
Canalex serisi kapalı tip kablo kanalları	34
Eko serisi kapalı tip kablo kanalları	34
Yapışkan bantlı kapalı tip kablo kanalları	34
Meks serisi kapalı tip kablo kanalları	35
Meks serisi klima kanalı ve aksesuarları	35
Tavan köşe kanalı	35
Süpürgelik kablo kanalları	35
Fugalı süpürgelik	35
Tezgah süpürgeliği	35
Balık sırtı zemin kanalları	35
H.Free flaret kanal ve aksesuarları	36
Kanal aksesuarları	37
Meks plus serisi için priz setleri	39
Kanal için ups ve enerji prizleri 45x45	40
Sidem serisi renkli kablo kanalları	43
Sidem serisi süpürgelikler ve aksesuarları	43
Bürokit ve döşeme altı buatlar	47
Rack kabin priz ve aksesuarları	49
Kablo toplama spirali ve kablo omurga kanalı	50
Kablolu spiraller	51
H. Free spiraller	54
Plastik spiraller	55
Hdpe koruge borular	55
Logar kutuları	55
Eko serisi çelik ve izole kaplı spiraller	56
Meks serisi çelik ve izole kaplı spiraller	56
Metal rakorlar	57
Pvc boy borular ve aksesuarları	58
Fiber klavuz, çelik susta ve plastik sustalar	58
H.Free borular	60
Kalın boy boru ve dirsek-muflar	61
Poliyeten yeraltı boruları	61
Kasa, buat ve kapakları	62
beton çivili kroşeler	63
Dübeller, vidalar ve kroşeler	63
Geçmeli ve tırnaklı tip buat klemensler	64
Klemensler	65
Aspiratör ve sanayi tip vantilatörler	66

içindekiler

aydınlatma grubu

Exit - acil aydınlatma armatürü	70
Led armatür çeşitleri	74
Armatür çeşitleri	75
Sensörlü armatür çeşitleri	76
Cam armatür çeşitleri	79
Döküm armatürler	81
Led paneller ve led projektörler	82
Etanj armatür	83
Duy çeşitleri	83
Bahçe armatürleri	84

otomasyon grubu

Promex delikli kanallar	86
Delikli kablo kanalları	89
Polyemid spiral ve aksesuarları	90
Süper etanj plastik rakorlar	90
Pano spiralleri	90
Kablo bağları ve yapışkan kroşeler	91
Abs panoları	92
Abs otomat panoları	93
Abs pano aksesuarları	94
Kofra, devre kesen ve buşonlar	94
Pano prizleri	95
Pano termostat ve fanları	96
Pano ısıtıcı ve güç kaynakları	102
Pano aydınlatma armatürleri ve siviçleri	104
Termal yazıcı, ribon ve etiket çeşitleri	105
Ray klemensler ve dağıtım üniteleri	106
Yüksükler	110
Skp çeşitleri	111
Koblo soyuca ve sıyırıcılar	112
Yüksük ve skp sıkma penseleri	114
Tornavida, pense ve takım çantaları	114
Maket bıçakları	114
Sinyal ve kumanda butonları	115
Potansiyometre, ampermetre ve voltmetre	125
Kumanda ve vinç kutuları	127
Kombinasyon panoları	131
Termoplastik buatlar ve kombinasyon kutuları	132
Sanayi tipi kauçuk fiş ve prizleri	134
Cee norm fiş ve prizler	136
Sanayi tipi fiş prizler ve basınç şalterleri	138
Seyyar el lambaları ve kablo makaraları	138
İkaz lambaları	139
Kapı otomatiği, trafolar, ziller ve butonları	144
Telefon dağıtım kutu ve aksesuarları	144
Döner, flaşör lambaları ve motorlu sirenler	145
Yangın ihbar ürünleri	146
Tamer reçineli ek mufları ve aksesuarları	148
Isı ile daralan makaronlar	152

PAYLAŞMAYI ÖNEMSIYORUZ...

Rita 2 USB'li çocuk korumalı priz ile enerjiyi paylaşıyoruz. 5V 2,4A enerji çıkışı ile 2 ayrı tablet, telefon gibi cihazlarınızın hızlı ve güvenli bir şekilde şarj olmasına olanak sağlıyor, bununla birlikte topraklı priz çıkışı ile diğer cihazlarınıza enerji vermeye devam ediyoruz...

Doya Doya
Oyun oynamak için...



Kesintisiz
Konuşmalarınız için...

Dizi keyfiniz için...



Rit 

Kusursuz  z mler iin...



ANAHTAR GRUBU VIDALI TİP



ANAHTAR GRUBU KLİPSLİ TİP (KOLAY BAĞLANTI)

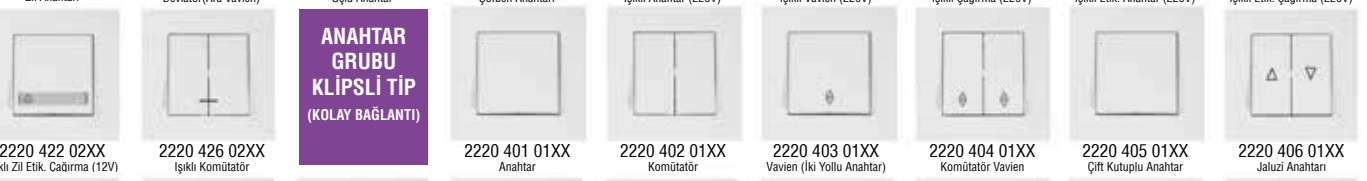

DİMMER GRUBU

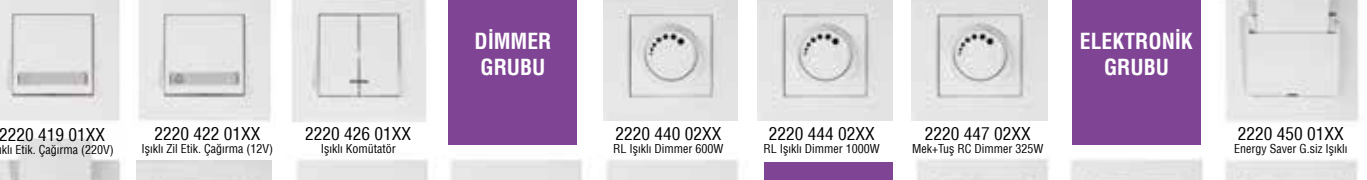

ELEKTRONİK GRUBU

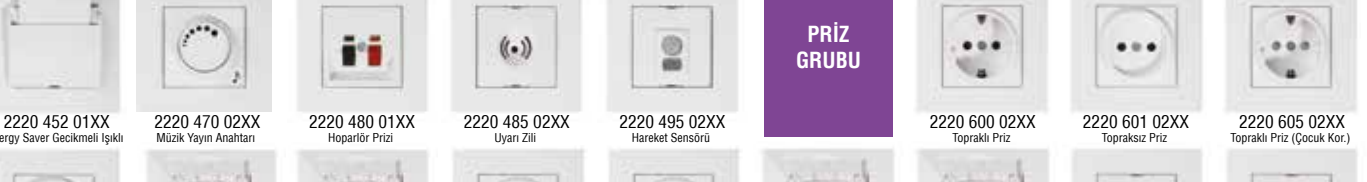

PRİZ GRUBU



İLETİŞİM GRUBU



TV / SAT GRUBU





NATURAL



01 - BEYAZ



02 - KREM

AHŞAP



56 - KIRAZ



57 - CEVİZ



58 - MEŞE

METALİK



80 - A.ALTIN



82 - INOX



83 - TİTANYUM



85 - DORE



84 - SİYAH



95 - FÜME

PASTEL



04 - KIRMIZI



06 - TURUNCU



08 - SARI



10 - YEŞİL



11 - PEMBE



12 - MAVİ



25 - MOR



09 - LACİVERT



03 - GRİ

Kod	Ürün Tanımı	Kutu Adedi	Koli Adedi	Beyaz/Krem Fiyat	Metalik Fiyat	Ahşap Fiyat
-----	-------------	------------	------------	------------------	---------------	-------------

Anahtar Grubu Vidalı Tip

2200 401 02XX	Mek+Tuş Anahtar (Vidalı)	12	120	9,44	13,91	13,97
2200 402 02XX	Mek+Tuş Komütatör (Vidalı)	12	120	11,38	15,92	16,02
2200 403 02XX	Mek+Tuş Vavien (İki Yollu Anahtar)(Vidalı)	12	120	11,75	15,19	15,33
2200 404 02XX	Mek+Tuş Komütatör Vavien (Vidalı)	12	120	18,92	22,73	23,12
2200 405 02XX	Mek+Tuş Çift Kutuplu Anahtar (Vidalı)	12	120	12,76	15,73	15,82
2200 406 02XX	Mek+Tuş Jaluzi Anahtarı (Vidalı)	12	120	16,98	22,05	22,51
2200 436 02XX	Mek+Tuş Jaluzi Anahtarı (Yaysız)(Vidalı)	12	120	16,98	22,05	22,51
2200 407 02XX	Mek+Tuş Çağırma (Vidalı)	12	120	11,95	15,03	15,41
2200 407 02XXX	Mek+Tuş Kapı Otomatiği Anahtarı (Vidalı)	12	120	11,95	15,03	15,41
2200 407 02XXZ	Mek+Tuş Zil Anahtarı (Vidalı)	12	120	11,95	15,03	16,50
2200 408 02XX	Mek+Tuş Deviyatör(Ara Vavien)(Vidalı)	12	120	17,83	22,76	23,05
2200 409 02XX	Mek+Tuş Üçlü Anahtar (Vidalı)	12	120	17,65	24,67	25,54
2200 411 02XX	Mek+Tuş Şofben Anahtarı (Vidalı)	12	120	14,49	17,70	18,11
2200 415 02XX	Mek+Tuş Işıklı Anahtar (220V) (Vidalı)	12	120	18,34	22,48	22,85
2200 416 02XX	Mek+Tuş Işıklı Vavien (220V) (Vidalı)	12	120	21,50	24,03	24,84
2200 417 02XX	Mek+Tuş Işıklı Çağırma (220V)(Vidalı)	12	120	18,53	24,37	25,13
2200 418 02XX	Mek+Tuş Işıklı Etik. Anahtar (220V)(Vidalı)	12	120	20,05	21,46	22,83
2200 419 02XX	Mek+Tuş Işıklı Etik. Çağırma (220V)(Vidalı)	12	120	19,99	21,28	22,65
2200 422 02XX	Mek+Tuş Işıklı Zil Etik. Çağırma (12V)(Vidalı)	12	120	17,13	20,30	20,49
2200 426 02XX	Mek+Tuş Işıklı Komütatör (Vidalı)	12	120	22,67	26,42	28,57

Anahtar Grubu Klipsli Tip (Kolay Bağlantı)

2200 401 01XX	Mek+Tuş Anahtar (Klipsli)	12	120	9,44	13,91	13,97
2200 402 01XX	Mek+Tuş Komütatör (Klipsli)	12	120	11,38	15,92	16,02
2200 403 01XX	Mek+Tuş Vavien (İki Yollu Anahtar)(Klipsli)	12	120	11,75	15,19	15,33
2200 404 01XX	Mek+Tuş Komütatör Vavien (Klipsli)	12	120	18,92	22,73	23,12
2200 405 01XX	Mek+Tuş Çift Kutuplu Anahtar (Klipsli)	12	120	12,76	15,73	15,82
2200 406 01XX	Mek+Tuş Jaluzi Anahtarı (Klipsli)	12	120	16,98	22,05	22,51
2200 436 01XX	Mek+Tuş Jaluzi Anahtarı (Yaysız)(Klipsli)	12	120	16,98	22,05	22,51
2200 407 01XX	Mek+Tuş Çağırma (Klipsli)	12	120	11,95	15,03	15,41
2200 407 01XXX	Mek+Tuş Kapı Otomatiği Anahtarı (Klipsli)	12	120	11,95	15,03	15,41
2200 407 01XXZ	Mek+Tuş Zil Anahtarı (Klipsli)	12	120	11,95	15,03	16,50
2200 408 01XX	Mek+Tuş Deviyatör(Ara Vavien)(Klipsli)	12	120	17,83	22,76	23,05
2200 409 01XX	Mek+Tuş Üçlü Anahtar (Klipsli)	12	120	17,65	24,67	25,54
2200 415 01XX	Mek+Tuş Işıklı Anahtar (220V) (Klipsli)	12	120	18,34	22,48	22,85
2200 416 01XX	Mek+Tuş Işıklı Vavien (220V) (Klipsli)	12	120	21,50	24,03	24,84
2200 417 01XX	Mek+Tuş Işıklı Çağırma (220V)(Klipsli)	12	120	18,53	24,37	25,13
2200 418 01XX	Mek+Tuş Işıklı Etik. Anahtar (220V)(Klipsli)	12	120	20,05	21,46	22,83
2200 419 01XX	Mek+Tuş Işıklı Etik. Çağırma (220V)(Klipsli)	12	120	19,99	21,28	22,65
2200 422 01XX	Mek+Tuş Işıklı Zil Etik. Çağırma (12V)(Klipsli)	12	120	17,13	20,30	20,49
2200 426 01XX	Mek+Tuş Işıklı Komütatör (Vidalı)	12	120	22,67	26,42	28,57

Dimmer Grubu

2200 440 02XX	Mek+Tuş RL Işıklı Dimmer 600W	8	80	96,18	98,59	102,17
2200 444 02XX	Mek+Tuş RL Işıklı Dimmer 1000W	8	80	121,47	124,73	129,57
2200 447 02XX	Mek+Tuş RC Dimmer 325W	8	80	101,79	104,25	107,80

Elektronik Grubu

2200 450 01XX	Mek+Tuş Energy Saver G.siz Işıklı	8	80	137,98	141,86	150,67
2200 452 01XX	Mek+Tuş Energy Saver Gecikmeli Işıklı	8	80	137,97	141,87	150,67
2200 470 02XX	Mek+Tuş Müzik Yayın Anahtarı	8	80	110,89	120,56	125,42
2200 480 01XX	Mek+Tuş Hoparlör Prizi	8	80	21,69	40,00	40,59
2200 485 02XX	Mek+Tuş Uyarı Zili	8	80	79,16	86,13	89,46
2200 495 02XX	Mek+Tuş Hareket Sensörü	8	80	154,12	171,38	178,76

Priz Grubu

2200 600 02XX	Mek+Tuş Topraklı Priz	12	120	10,51	16,14	19,32
2200 601 02XX	Mek+Tuş Topraksız Priz	12	120	9,84	14,69	17,64
2200 605 02XX	Mek+Tuş Topraklı Priz (Çocuk Kor.)	12	120	12,85	19,71	22,92
2200 606 02XX	Mek+Tuş Topraksız Priz (Çocuk Kor.)	12	120	11,05	17,03	20,02
2200 610 02XX	Mek+Tuş Kapaklı Topraklı Priz	12	120	12,80	17,15	22,09
2200 611 02XX	Mek+Tuş Kapaklı Topraklı Priz (Çoc. Kor.)	12	120	15,13	23,13	28,72
2200 615 02XX	Mek+Tuş Ups (Fransız) Prizi	12	120	14,05	24,41	28,67
2200 616 02XX	Mek+Tuş Ups (Fransız) Prizi (Çoc. Kor.)	12	120	15,47	25,03	29,82
2200 617 02XX	Mek+Tuş Ups Kapaklı (Fransız) Priz	12	120	16,55	27,87	34,79
2200 618 02XX	Mek+Tuş Ups Kapaklı (Fr.) Priz (Çoc. Kor.)	12	120	15,83	29,24	35,88
2220 200 02XX	İkili Topraklı Priz Porselen (Çerçeve Dahil)	5	50	23,15	37,47	37,12
2220 201 02XX	İkili Topraksız Priz Porselen (Çerçeve Dahil)	5	50	19,26	34,95	35,27
2220 202 02XX	İkili Topraklı Priz (Çerçeve Dahil)	5	50	21,75	35,73	35,35
2220 203 02XX	İkili Topraksız Priz (Çerçeve Dahil)	5	50	17,97	30,88	32,42
2220 215 01XX	İkili Ups Priz (Çerçeve Dahil)	5	50	22,00	38,30	37,97
2200 448 01XX	Mek+Tuş Tekli Usb Şarj Prizi	5	50	60,24	72,88	80,86
2200 449 01XX	Mek+Tuş İkili Usb Şarj Prizi	5	50	64,12	76,47	83,73
2220 619 02XX	İkili Usb Topraklı Priz (Çerçeve Dahil)	8	—	77,15	92,00	98,20



Çoklu çerçeve ile kullanılamaz.





Kod	Ürün Tanımı	Kutu Adedi	Koli Adedi	Beyaz/Krem Fiyat	Metalik Fiyat	Ahşap Fiyat
-----	-------------	------------	------------	------------------	---------------	-------------

İletişim Grubu

2200 125 01XX	Mek+Tuş Telefon Prizi 1Xrj12 (Cat3)	12	120	16,15	19,35	19,73
2200 126 01XX	Mek+Tuş Telefon Prizi 2Xrj12 (Cat3)	12	120	25,30	32,05	32,56
2200 128 01XX	Mek+Tuş Etiketli Tlf Data Priz (Kon.süz)	12	120	8,42	11,27	13,20
2200 135 02XX	Mek+Tuş Data Prizi 1*Rj45 (Kon.süz)	12	120	7,04	10,16	13,20
2200 136 01XX	Mek+Tuş Data Prizi 1*Rj45 (Cat5e)	12	120	21,38	33,03	34,55
2200 137 01XX	Mek+Tuş Data Prizi 2*Rj45 (Kon.süz)	12	120	7,67	10,06	13,20
2200 138 01XX	Mek+Tuş Data Prizi 2*Rj45 (Cat5e)	12	120	35,36	52,22	54,61
2200 139 01XX	Mek+Tuş Tlf Data Priz (Rj12 Cat3 + Cat5e)	12	120	32,37	51,50	53,34
2200 140 01XX	Mek+Tuş Data Prizi 1*Rj45 (Cat6)	12	120	26,03	36,34	37,73
2200 141 01XX	Mek+Tuş Data Prizi 2*Rj45 (Cat6)	12	120	48,21	58,50	60,82
2200 455 01XX	Mek+Tuş Data Prizi 1*Usb	12	120	37,87	40,89	41,96
2200 456 01XX	Mek+Tuş Data Prizi 2*Usb	12	120	67,59	72,00	74,63
2200 457 01XX	Mek+Tuş Data Prizi 1*Hdmı	12	120	51,64	52,54	54,15
2200 458 01XX	Mek+Tuş Data Prizi 2*Hdmı	12	120	95,14	96,54	98,30
2200 459 01XX	Mek+Tuş Data Prizi 1*Usb/1*Hdmı	12	120	81,66	82,80	85,97
2200 460 01XX	Mek+Tuş VGA Priz	12	120	86,26	110,15	121,64
YENİ 2200 461 01XX	Mek+Tuş İki Çıkışlı Fiber Optik Priz	12	120	39,30	49,75	54,60
2200 121 02XX	Mek+Tuş Kör Kapak	12	120	5,59	14,29	14,68

TV / Sat Grubu

2200 156 02XX	Mek+Tuş Tv-Sat Prizi (Geçişli) 4DB/F Kon.	12	120	65,75	79,35	83,96
2200 157 02XX	Mek+Tuş Tv-Sat Prizi (Sonlu)	12	120	65,75	79,35	83,96
2200 166 01XX	Mek+Tuş Sat Prizi (Geçişli) 4DB/F Kon.	12	120	36,95	45,97	47,38
2200 167 01XX	Mek+Tuş Sat Prizi (Sonlu)	12	120	36,95	45,97	47,38
2200 170 01XX	Mek+Tuş Tv Prizi (Geçişli) 11DB	12	120	28,77	31,79	32,02
2200 171 01XX	Mek+Tuş Tv Prizi (Sonlu)	12	120	28,77	31,79	32,02
2200 172 01XX	Mek+Tuş Tv Prizi F Dişi	12	120	11,58	12,33	14,88

Çerçeveler

2220 800 11XX	Tekli Çerçeve	20	400	1,76	3,81	6,41
2220 800 12XX	İkili Yatay Çerçeve	10	200	9,90	11,738	16,43
2220 800 13XX	Üçlü Yatay Çerçeve	10	50	12,90	20,584	22,23
2220 800 14XX	Dörtlü Yatay Çerçeve	10	50	15,90	24,618	27,43
2220 800 15XX	Beşli Yatay Çerçeve	10	50	18,06	29,332	30,13
2220 800 16XX	Altılı Yatay Çerçeve	10	50	21,20	38,142	39,78
2220 800 22XX	İkili Dikey Çerçeve	10	50	9,90	11,738	16,43
2220 800 23XX	Üçlü Dikey Çerçeve	10	50	12,90	20,584	22,23
2220 800 24XX	Dörtlü Dikey Çerçeve	10	50	15,90	24,618	27,43
2220 800 25XX	Beşli Dikey Çerçeve	10	50	18,06	29,332	30,13
2220 800 26XX	Altılı Dikey Çerçeve	10	50	21,20	38,142	39,78
2220 820 12XX	İkili Priz Çerçeve	12	60	3,80	6,22	11,05
2100 000 11XX	Sıva Üstü Kasa	12	60	5,43	12,88	14,20
2200 800 00XX	Telefon Tutucu	24	240	2,50	3,80	—
YENİ 2200 000 0001	IP44 Kapaklı Priz Conta (Resmi Sayfa 28'de)	24	120	4,00	—	—

► RİTA PASTEL

Çerçeveler	Pastel Fiyat
2220 800 11XX	1,83
2220 800 12XX	10,59
2220 800 13XX	13,80
2220 800 14XX	17,01
2220 800 15XX	19,32
2220 800 16XX	22,68
2220 800 22XX	10,59
2220 800 23XX	13,80
2220 800 24XX	17,01
2220 800 25XX	19,32
2220 800 26XX	22,68





Elitra | Plus

Sıradanlığa meydan okuyun...



Elitra | Plus

Elitra Glass



XXX-811



XXX-814



► BEYAZ / SİYAH

Kod	Ürün Tanımı	Kutu Adedi	Fiyat
2170 XXX 11XX	Tekli Çerçeve	10	80,12
2170 XXX 12XX	Yatay İkili Çerçeve	10	130,48
2170 XXX 13XX	Yatay Üçlü Çerçeve	10	238,94
2170 XXX 14XX	Yatay Dörtlü Çerçeve	10	292,37
2170 XXX 15XX	Yatay Beşli Çerçeve	10	359,33
2170 XXX 22XX	Dikey İkili Çerçeve	10	130,48
2170 XXX 23XX	Dikey Üçlü Çerçeve	10	238,94
2170 XXX 24XX	Dikey Dörtlü Çerçeve	10	292,37
2170 XXX 25XX	Dikey Beşli Çerçeve	10	359,33

Elitra Chrome



XXX-821



XXX-824

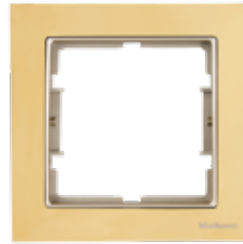

XXX-822

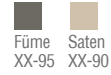

► KROM / PASLANMAZ ÇELİK / ALTIN

Kod	Ürün Tanımı	Kutu Adedi	Fiyat
2170 XXX 11XX	Tekli Çerçeve	10	85,08
2170 XXX 12XX	Yatay İkili Çerçeve	10	162,76
2170 XXX 13XX	Yatay Üçlü Çerçeve	10	237,03
2170 XXX 14XX	Yatay Dörtlü Çerçeve	10	280,53
2170 XXX 15XX	Yatay Beşli Çerçeve	10	377,07
2170 XXX 16XX	Yatay Altılı Çerçeve	10	465,95
2170 XXX 22XX	Dikey İkili Çerçeve	10	162,76
2170 XXX 23XX	Dikey Üçlü Çerçeve	10	237,03
2170 XXX 24XX	Dikey Dörtlü Çerçeve	10	280,53
2170 XXX 25XX	Dikey Beşli Çerçeve	10	377,07
2170 XXX 26XX	Dikey Altılı Çerçeve	10	465,95



XXX-825



XXX-825

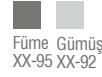

Füme Gümüş
XX-95 XX-92

► **GÜMÜŞ - PARLAK FÜME**

Kod	Ürün Tanımı	Kutu Adedi	Fiyat
2170 825 11XX	Tekli Çerçeve	10	67,47
2170 825 12XX	Yatay İkili Çerçeve	10	106,02
2170 825 13XX	Yatay Üçlü Çerçeve	10	166,05
2170 825 14XX	Yatay Dörtlü Çerçeve	10	206,21
2170 825 15XX	Yatay Beşli Çerçeve	10	246,42
2170 825 16XX	Yatay Altılı Çerçeve	10	248,40
2170 825 22XX	Dikey İkili Çerçeve	10	106,02
2170 825 23XX	Dikey Üçlü Çerçeve	10	166,05
2170 825 24XX	Dikey Dörtlü Çerçeve	10	206,21
2170 825 25XX	Dikey Beşli Çerçeve	10	248,42
2170 825 26XX	Dikey Altılı Çerçeve	10	243,40



XXX-827



XXX-828



Füme Saten
XX-95 XX-90

► **MAT ALÜMİNYUM - MAT SATEN**

Kod	Ürün Tanımı	Kutu Adedi	Fiyat
2170 XXX 11XX	Tekli Çerçeve	10	53,65
2170 XXX 12XX	Yatay İkili Çerçeve	10	90,54
2170 XXX 13XX	Yatay Üçlü Çerçeve	10	136,90
2170 XXX 14XX	Yatay Dörtlü Çerçeve	10	175,06
2170 XXX 15XX	Yatay Beşli Çerçeve	10	277,94
2170 XXX 16XX	Yatay Altılı Çerçeve	10	414,93
2170 XXX 22XX	Dikey İkili Çerçeve	10	90,54
2170 XXX 23XX	Dikey Üçlü Çerçeve	10	136,90
2170 XXX 24XX	Dikey Dörtlü Çerçeve	10	175,06
2170 XXX 25XX	Dikey Beşli Çerçeve	10	277,94
2170 XXX 26XX	Dikey Altılı Çerçeve	10	414,93

Elitra Plus

Elitra Wood

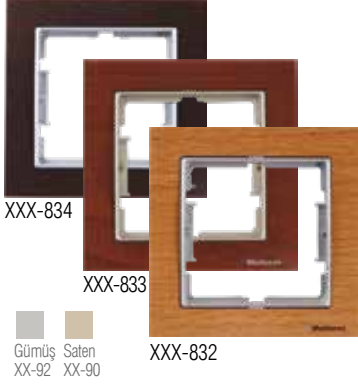

► KAYIN / KIRAZ / VENGE

Kod	Ürün Tanımı	Kutu Adedi	Fiyat
2170 XXX 11XX	Tekli Çerçeve	10	79,45
2170 XXX 12XX	Yatay İkili Çerçeve	10	92,36
2170 XXX 13XX	Yatay Üçlü Çerçeve	10	150,55
2170 XXX 14XX	Yatay Dörtlü Çerçeve	10	196,16
2170 XXX 15XX	Yatay Beşli Çerçeve	10	241,20
2170 XXX 22XX	Dikey İkili Çerçeve	10	92,36
2170 XXX 23XX	Dikey Üçlü Çerçeve	10	150,55
2170 XXX 24XX	Dikey Dörtlü Çerçeve	10	196,16
2170 XXX 25XX	Dikey Beşli Çerçeve	10	241,20

Elitra Marble



► BLACK QUARTZ / SAND STONE

Kod	Ürün Tanımı	Kutu Adedi	Fiyat
2170 XXX 11XX	Tekli Çerçeve	10	105,14
2170 XXX 12XX	Yatay İkili Çerçeve	10	120,54
2170 XXX 13XX	Yatay Üçlü Çerçeve	10	186,98
2170 XXX 14XX	Yatay Dörtlü Çerçeve	10	227,99
2170 XXX 15XX	Yatay Beşli Çerçeve	10	279,86
2170 XXX 22XX	Dikey İkili Çerçeve	10	120,54
2170 XXX 23XX	Dikey Üçlü Çerçeve	10	186,98
2170 XXX 24XX	Dikey Dörtlü Çerçeve	10	227,99
2170 XXX 25XX	Dikey Beşli Çerçeve	10	279,86

Elitra Ale

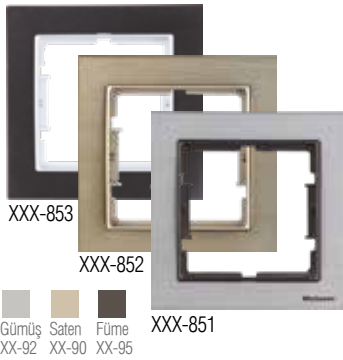

► NATURAL / SATEN / MAT FÜME

Kod	Ürün Tanımı	Kutu Adedi	Fiyat
2170 XXX 11XX	Tekli Çerçeve	10	43,53
2170 XXX 12XX	Yatay İkili Çerçeve	10	87,15
2170 XXX 13XX	Yatay Üçlü Çerçeve	10	145,57
2170 XXX 14XX	Yatay Dörtlü Çerçeve	10	197,75
2170 XXX 15XX	Yatay Beşli Çerçeve	10	232,16
2170 XXX 16XX	Yatay Altılı Çerçeve	10	448,47
2170 XXX 22XX	Dikey İkili Çerçeve	10	87,15
2170 XXX 23XX	Dikey Üçlü Çerçeve	10	145,57
2170 XXX 24XX	Dikey Dörtlü Çerçeve	10	197,75
2170 XXX 25XX	Dikey Beşli Çerçeve	10	232,16
2170 XXX 26XX	Dikey Altılı Çerçeve	10	448,47



Elitra Plus Serisi

Mekanizma + Tuş Ürün Listesi

BEYAZ-01 / SATEN-90 / GÜMÜŞ-92 / FÜME-95

Kod	Ürün Tanıtımı	Kutu Adedi	Fiyat
-----	---------------	------------	-------

Anahtar Grubu Vidalı Tip

2270 401 02XX	Mek+Tuş Anahtar	10	13,91
2270 402 02XX	Mek+Tuş Komütatör	10	15,92
2270 403 02XX	Mek+Tuş Vavien (İki Yollu Anahtar)	10	15,19
2270 404 02XX	Mek+Tuş Komütatör Vavien	10	22,73
2270 405 02XX	Mek+Tuş Çift Kutuplu Anahtar	10	15,73
2270 406 02XX	Mek+Tuş Jaluzi Anahtar-Yaylı	10	22,05
2270 407 02XX	Mek+Tuş Light (Çağırma)	10	15,03
2270 407 02XXZ	Mek+Tuş Zil Anahtarı	10	15,03
2270 407 02XXK	Mek+Tuş Kapı Otomatiği Anahtarı	10	15,03
2270 408 02XX	Mek+Tuş Deviatör (Ara Vavien)	10	22,76
2270 409 02XX	Mek+Tuş Uçlu Anahtar	10	24,67
2270 411 02XX	Mek+Tuş Şofben Anahtarı	10	17,70
2270 415 02XX	Mek+Tuş Işıklı Anahtar (220V)	10	22,48
2270 416 02XX	Mek+Tuş Işıklı Vavien (220V)	10	24,03
2270 417 02XX	Mek+Tuş Işıklı Çağırma (220V)	10	24,37
2270 418 02XX	Mek+Tuş Işıklı Etiketli Anahtar (220V)	10	21,46
2270 419 02XX	Mek+Tuş Işıklı Etiketli Çağırma (220V)	10	21,28
2270 422 02XX	Mek+Tuş Işıklı Zil Etiketli Çağırma (12V)	10	20,30
2270 426 02XX	Mek+Tuş Işıklı Komütatör	10	26,42

Anahtar Grubu Klipsli Tip (Kolay Bağlantı)

2270 401 01XX	Mek+Tuş Anahtar	10	13,91
2270 402 01XX	Mek+Tuş Komütatör	10	15,92
2270 403 01XX	Mek+Tuş Vavien (İki Yollu Anahtar)	10	15,19
2270 404 01XX	Mek+Tuş Komütatör Vavien	10	22,73
2270 405 01XX	Mek+Tuş Çift Kutuplu Anahtar	10	15,73
2270 406 01XX	Mek+Tuş Jaluzi Anahtar-Yaylı	10	22,05
2270 407 01XX	Mek+Tuş Light (Çağırma)	10	15,03
2270 407 01XXZ	Mek+Tuş Zil Anahtarı	10	15,03
2270 407 01XXK	Mek+Tuş Kapı Otomatiği Anahtarı	10	15,03
2270 408 01XX	Mek+Tuş Deviatör (Ara Vavien)	10	22,76
2270 409 01XX	Mek+Tuş Uçlu Anahtar	10	24,67
2270 415 01XX	Mek+Tuş Işıklı Anahtar (220V)	10	22,48
2270 416 01XX	Mek+Tuş Işıklı Vavien (220V)	10	24,03
2270 417 01XX	Mek+Tuş Işıklı Çağırma (220V)	10	24,37
2270 418 01XX	Mek+Tuş Işıklı Etiketli Anahtar (220V)	10	21,46
2270 419 01XX	Mek+Tuş Işıklı Etiketli Çağırma (220V)	10	21,28
2270 422 01XX	Mek+Tuş Işıklı Zil Etiketli Çağırma (12V)	10	20,30
2270 426 01XX	Mek+Tuş Işıklı Komütatör	10	26,42

Dimmer Grubu

2270 440 02XX	Mek+Tuş Işıklı Dimmer 600W	8	98,59
2270 444 02XX	Mek+Tuş Işıklı Dimmer 1000W	8	124,73
2270 447 02XX	Mek+Tuş RC Dimmer 325W	8	104,25

Elektronik Grubu

2270 050 01XX	Mek+Tuş Energy Saver Gecikmesiz Işıklı	8	141,86
2270 052 01XX	Mek+Tuş Energy Saver Gecikmeli	8	141,87
2270 070 02XX	Mek+Tuş Müzik Yayın Anahtarı	8	120,56
2270 080 01XX	Mek+Tuş Hoparlör Prizi	10	40,00
2270 085 02XX	Mek+Tuş Uyarı Zili	10	86,130
2270 095 02XX	Mek+Tuş Hareket Sensörü	10	171,38

Priz Grubu

2270 600 02XX	Mek+Tuş Topraklı Priz	10	16,14
2270 601 02XX	Mek+Tuş Topraksız Priz	10	14,69
2270 605 02XX	Mek+Tuş Topraklı Priz (Çocuk Korumalı)	10	19,71
2270 606 02XX	Mek+Tuş Topraksız Priz (Çocuk Korumalı)	10	17,03
2270 610 02XX	Mek+Tuş Kapaklı Topraklı Priz	10	17,15
2270 611 02XX	Mek+Tuş Kapaklı Topraklı Priz (Çoc. Korml)	10	23,13
2270 615 02XX	Mek+Tuş Ups (Fransız) Prizi	10	24,42
2270 616 02XX	Mek+Tuş Ups (Fransız) Prizi(Çoc. Korumalı)	10	25,03
2270 617 02XX	Mek+Tuş Ups Kapaklı (Fransız) Priz	10	27,88
2270 618 02XX	Mek+Tuş Ups Kap. (Fransız) Priz (Çoc. Korml)	10	29,24
2270 121 02XX	Mek+Tuş Kör Kapak	10	14,29

İletişim Grubu

2270 455 01XX	Mek+Tuş Data Prizi 1*Usb	10	40,89
2270 456 01XX	Mek+Tuş Data Prizi 2*Usb	10	72,00
2270 457 01XX	Mek+Tuş Data Prizi 1*Hdmi	10	52,54
2270 458 01XX	Mek+Tuş Data Prizi 2*Hdmi	10	94,54
2270 459 01XX	Mek+Tuş Data Prizi 1*Usb/1*Hdmi	10	82,80
2270 125 01XX	Mek+Tuş Telefon Prizi 1*Rj12 Cat3	10	19,35
2270 126 01XX	Mek+Tuş Telefon Prizi 2*Rj12 Cat3	10	32,05
2270 128 01XX	Mek+Tuş Etiketli Tlf+Data Priz (Kon.süz)	10	11,27
2270 135 01XX	Mek+Tuş Data Prizi 1*Rj45 (Kon.süz)	10	10,16
2270 136 01XX	Mek+Tuş Data Prizi 1*Rj45 (Cat5e)	10	33,03
2270 137 01XX	Mek+Tuş Data Prizi 2*Rj45 (Kon.süz)	10	10,06
2270 138 01XX	Mek+Tuş Data Prizi 2*Rj45 (Cat5e)	10	52,22
2270 139 01XX	Mek+Tuş Tlf+Data Priz (Rj12 Cat3+Cat5e)	10	51,50
2270 140 01XX	Mek+Tuş Data Prizi 1*Rj45 (Cat6)	10	36,34
2270 141 01XX	Mek+Tuş Data Prizi 2*Rj45 (Cat6)	10	58,50

TV / Sat Grubu

2270 156 02XX	Mek+Tuş Tv-Sat Prizi (Geçişli) 4DB/F Kon.	10	79,35
2270 157 02XX	Mek+Tuş Tv-Sat Prizi (Sonlu)	10	79,35
2270 166 01XX	Mek+Tuş Sat Prizi (Geçişli) 4DB/F Konnektör	10	45,97
2270 167 01XX	Mek+Tuş Sat Prizi (Sonlu)	10	45,97
2270 170 01XX	Mek+Tuş Tv Prizi (Geçişli) 11DB	10	31,79
2270 171 01XX	Mek+Tuş Tv Prizi (Sonlu)	10	31,79
2270 172 01XX	Mek+Tuş Tv Prizi F Dişi	10	12,33



Beyaz
 Saten
 Gümüş
 Füme
 XX-01 XX-90 XX-92 XX-95

Candelä

Şık Çözümler için...



ANAHTAR GRUBU VİDALI TİP																
			ANAHTAR GRUBU KLİPSLİ TİP (KOLAY BAĞLANTI)													
					DİMMER GRUBU				ELEKTRONİK GRUBU							
								PRİZ GRUBU								
	İLETİŞİM GRUBU															
TV / SAT GRUBU																

NATURAL



01 - BEYAZ



02 - KREM

AHŞAP



56 - KIRAZ



57 - CEVİZ



58 - MEŞE

METALİK



80 - A.ALTIN



82 - İNOX



83 - TİTANYUM



85 - DORE



84 - SİYAH



95 - FÜME



Candela

Mekanizma + Tuş Ürün Listesi

Kod	Ürün Tanımı	Kutu Adedi	Koli Adedi	Beyaz/Krem Fiyat	Metalik Fiyat	Ahşap Fiyat
-----	-------------	------------	------------	------------------	---------------	-------------

Anahtar Grubu Vidalı Tip

2100 401 02XX	Mek+Tuş Anahtar (Vidalı)	12	120	9,44	13,91	13,97
2100 402 02XX	Mek+Tuş Komütatör (Vidalı)	12	120	11,38	15,92	16,02
2100 403 02XX	Mek+Tuş Vavien (İki Yollu Anahtar)(Vidalı)	12	120	11,75	15,19	15,33
2100 404 02XX	Mek+Tuş Komütatör Vavien (Vidalı)	12	120	18,92	22,73	23,12
2100 405 02XX	Mek+Tuş Çift Kutuplu Anahtar (Vidalı)	12	120	12,76	15,73	15,82
2100 406 02XX	Mek+Tuş Jalu Anahtarı (Vidalı)	12	120	16,98	22,05	22,51
2100 436 02XX	Mek+Tuş Jalu Anahtarı (Yaysız)(Vidalı)	12	120	16,98	22,05	22,51
2100 407 02XX	Mek+Tuş Çağırma (Vidalı)	12	120	11,95	15,03	15,41
2100 407 02XXK	Mek+Tuş Kapı Otomatığı Anahtarı (Vidalı)	12	120	11,95	15,03	15,41
2100 407 02XXZ	Mek+Tuş Zil Anahtarı (Vidalı)	12	120	11,95	15,03	16,50
2100 408 02XX	Mek+Tuş Deviyatör(Ara Vavien)(Vidalı)	12	120	17,83	22,76	23,05
2100 409 02XX	Mek+Tuş Üçlü Anahtar (Vidalı)	12	120	17,65	24,67	25,54
2100 411 02XX	Mek+Tuş Şofben Anahtarı (Vidalı)	12	120	14,49	17,70	18,11
2100 415 02XX	Mek+Tuş Işıklı Anahtar (220V) (Vidalı)	12	120	18,34	22,48	22,85
2100 416 02XX	Mek+Tuş Işıklı Vavien (220V) (Vidalı)	12	120	21,50	24,03	24,84
2100 417 02XX	Mek+Tuş Işıklı Çağırma (220V)(Vidalı)	12	120	18,53	24,37	25,13
2100 418 02XX	Mek+Tuş Işıklı Etik. Anahtar (220V)(Vidalı)	12	120	20,05	21,46	22,83
2100 419 02XX	Mek+Tuş Işıklı Etik. Çağırma (220V)(Vidalı)	12	120	19,99	21,28	22,65
2100 422 02XX	Mek+Tuş Işıklı Zil Etik. Çağırma (12V)(Vidalı)	12	120	17,13	20,30	20,49
2100 426 02XX	Mek+Tuş Işıklı Komütatör (Vidalı)	12	120	22,67	26,42	28,57

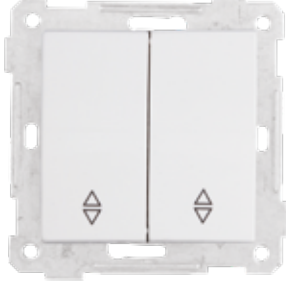

Anahtar Grubu Klipsli Tip (Kolay Bağlantı)

2100 401 01XX	Mek+Tuş Anahtar (Klipsli)	12	120	9,44	13,91	13,97
2100 402 01XX	Mek+Tuş Komütatör (Klipsli)	12	120	11,38	15,92	16,02
2100 403 01XX	Mek+Tuş Vavien (İki Yollu Anahtar)(Klipsli)	12	120	11,75	15,19	15,33
2100 404 01XX	Mek+Tuş Komütatör Vavien (Klipsli)	12	120	18,92	22,73	23,12
2100 405 01XX	Mek+Tuş Çift Kutuplu Anahtar (Klipsli)	12	120	12,76	15,73	15,82
2100 406 01XX	Mek+Tuş Jalu Anahtarı (Klipsli)	12	120	16,98	22,05	22,51
2100 436 01XX	Mek+Tuş Jalu Anahtarı (Yaysız)(Klipsli)	12	120	16,98	22,05	22,51
2100 407 01XX	Mek+Tuş Çağırma (Klipsli)	12	120	11,95	15,03	15,41
2100 407 01XXK	Mek+Tuş Kapı Otomatığı Anahtarı (Klipsli)	12	120	11,95	15,03	15,41
2100 407 01XXZ	Mek+Tuş Zil Anahtarı (Klipsli)	12	120	11,95	15,03	16,50
2100 408 01XX	Mek+Tuş Deviyatör(Ara Vavien)(Klipsli)	12	120	17,83	22,76	23,05
2100 409 01XX	Mek+Tuş Üçlü Anahtar (Klipsli)	12	120	17,65	24,67	25,54
2100 415 01XX	Mek+Tuş Işıklı Anahtar (220V) (Klipsli)	12	120	18,34	22,48	22,85
2100 416 01XX	Mek+Tuş Işıklı Vavien (220V) (Klipsli)	12	120	21,50	24,03	24,84
2100 417 01XX	Mek+Tuş Işıklı Çağırma (220V)(Klipsli)	12	120	18,53	24,37	25,13
2100 418 01XX	Mek+Tuş Işıklı Etik. Anahtar (220V)(Klipsli)	12	120	20,05	21,46	22,83
2100 419 01XX	Mek+Tuş Işıklı Etik. Çağırma (220V)(Klipsli)	12	120	19,99	21,28	22,65
2100 422 01XX	Mek+Tuş Işıklı Zil Etik. Çağırma (12V)(Klipsli)	12	120	17,13	20,30	20,49
2100 426 01XX	Mek+Tuş Işıklı Komütatör (Vidalı)	12	120	22,67	26,42	28,57



Dimmer Grubu

2100 440 02XX	Mek+Tuş RL Işıklı Dimmer 600W	8	80	96,18	98,59	102,17
2100 444 02XX	Mek+Tuş RL Işıklı Dimmer 1000W	8	80	121,47	124,73	129,57
2100 447 02XX	Mek+Tuş RC Dimmer 325W	8	80	101,79	104,25	107,80



Elektronik Grubu

2100 450 01XX	Mek+Tuş Energy Saver G.siz Işıklı	8	80	137,98	141,86	150,67
2100 452 01XX	Mek+Tuş Energy Saver Gecikmeli Işıklı	8	80	137,97	141,87	150,67
2100 470 02XX	Mek+Tuş Müzik Yayın Anahtarı	8	80	110,89	120,56	125,42
2100 480 01XX	Mek+Tuş Hoparlör Prizi	8	80	21,69	40,00	40,59
2100 485 02XX	Mek+Tuş Uyarı Zili	8	80	79,16	86,13	89,46
2100 495 02XX	Mek+Tuş Hareket Sensörü	8	80	154,12	171,38	178,76

Priz Grubu

2100 600 02XX	Mek+Tuş Topraklı Priz	12	120	10,51	16,14	19,32
2100 601 02XX	Mek+Tuş Topraksız Priz	12	120	9,84	14,69	17,64
2100 605 02XX	Mek+Tuş Topraklı Priz (Çocuk Kor.)	12	120	12,85	19,71	22,92
2100 606 02XX	Mek+Tuş Topraksız Priz (Çocuk Kor.)	12	120	11,05	17,03	20,02
2100 610 02XX	Mek+Tuş Kapaklı Topraklı Priz	12	120	12,80	17,15	22,09
2100 611 02XX	Mek+Tuş Kapaklı Topraklı Priz (Çoc. Kor.)	12	120	15,13	23,13	28,72
2100 615 02XX	Mek+Tuş Ups (Fransız) Prizi	12	120	14,05	24,41	28,67
2100 616 02XX	Mek+Tuş Ups (Fransız) Prizi (Çoc. Kor.)	12	120	15,47	25,03	29,82
2100 617 02XX	Mek+Tuş Ups Kapaklı (Fransız) Priz	12	120	16,55	27,87	34,79
2100 618 02XX	Mek+Tuş Ups Kapaklı (Fr.) Priz (Çoc. Kor.)	12	120	15,83	29,24	35,88
2120 200 02XX	İkili Topraklı Priz Porselen (Çerçeve Dahil)	5	50	23,15	37,47	37,12
2120 201 02XX	İkili Topraksız Priz Porselen (Çerçeve Dahil)	5	50	19,26	34,95	35,27
2120 202 02XX	İkili Topraklı Priz (Çerçeve Dahil)	5	50	21,75	35,73	35,35
2120 203 02XX	İkili Topraksız Priz (Çerçeve Dahil)	5	50	17,97	30,88	32,42
2120 215 01XX	İkili Ups Priz (Çerçeve Dahil)	5	50	22,00	38,30	37,97
2100 448 01XX	Mek+Tuş Tekli Usb Şarj Prizi	5	50	60,24	72,88	80,86
2100 449 01XX	Mek+Tuş İkili Usb Şarj Prizi	5	50	64,12	76,47	83,73



Candela

Mekanizma + Tuş Ürün Listesi

Kod	Ürün Tanımı	Kutu Adedi	Koli Adedi	Beyaz/Krem Fiyat	Metalik Fiyat	Ahşap Fiyat
-----	-------------	------------	------------	------------------	---------------	-------------

İletişim Grubu

2100 125 01XX	Mek+Tuş Telefon Prizi 1Xrj12 (Cat3)	12	120	16,15	19,35	19,73
2100 126 01XX	Mek+Tuş Telefon Prizi 2Xrj12 (Cat3)	12	120	25,30	32,05	32,56
2100 128 01XX	Mek+Tuş Etiketli Tlf Data Priz (Kon.süz)	12	120	8,42	11,27	13,20
2100 135 02XX	Mek+Tuş Data Prizi 1*Rj45 (Kon.süz)	12	120	7,04	10,16	13,20
2100 136 01XX	Mek+Tuş Data Prizi 1*Rj45 (Cat5e)	12	120	21,38	33,03	34,55
2100 137 01XX	Mek+Tuş Data Prizi 2*Rj45 (Kon.süz)	12	120	7,67	10,06	13,20
2100 138 01XX	Mek+Tuş Data Prizi 2*Rj45 (Cat5e)	12	120	35,36	52,22	54,61
2100 139 01XX	Mek+Tuş Tlf Data Priz (Rj12 Cat3 + Cat5e)	12	120	32,37	51,50	53,34
2100 140 01XX	Mek+Tuş Data Prizi 1*Rj45 (Cat6)	12	120	26,03	36,34	37,73
2100 141 01XX	Mek+Tuş Data Prizi 2*Rj45 (Cat6)	12	120	48,21	58,50	60,82
2100 455 01XX	Mek+Tuş Data Prizi 1*Usb	12	120	37,87	40,89	41,96
2100 456 01XX	Mek+Tuş Data Prizi 2*Usb	12	120	67,59	72,00	74,63
2100 457 01XX	Mek+Tuş Data Prizi 1*Hdmi	12	120	51,64	52,54	54,15
2100 458 01XX	Mek+Tuş Data Prizi 2*Hdmi	12	120	95,14	96,54	98,30
2100 459 01XX	Mek+Tuş Data Prizi 1*Usb/1*Hdmi	12	120	81,66	82,80	85,97
2100 460 01XX	Mek+Tuş VGA Priz	12	120	86,26	110,15	121,64
2100 121 02XX	Mek+Tuş Kör Kapak	12	120	5,59	14,29	14,68

TV / Sat Grubu

2100 156 02XX	Mek+Tuş Tv-Sat Prizi (Geçişli) 4DB/F Kon.	12	120	65,75	79,35	83,96
2100 157 02XX	Mek+Tuş Tv-Sat Prizi (Sonlu)	12	120	65,75	79,35	83,96
2100 166 01XX	Mek+Tuş Sat Prizi (Geçişli) 4DB/F Kon.	12	120	36,95	45,97	47,38
2100 167 01XX	Mek+Tuş Sat Prizi (Sonlu)	12	120	36,95	45,97	47,38
2100 170 01XX	Mek+Tuş Tv Prizi (Geçişli) 11DB	12	120	28,77	31,79	32,02
2100 171 01XX	Mek+Tuş Tv Prizi (Sonlu)	12	120	28,77	31,79	32,02
2100 172 01XX	Mek+Tuş Tv Prizi F Dişi	12	120	11,58	12,33	14,88

Çerçeveler

2125 800 11XX	Tekli Çerçeve	20	400	1,76	3,81	6,41
2125 800 12XX	İkili Yatay Çerçeve	10	200	9,90	11,738	16,43
2125 800 13XX	Üçlü Yatay Çerçeve	10	50	12,90	20,584	22,23
2125 800 14XX	Dörtlü Yatay Çerçeve	10	50	15,90	24,618	27,43
2125 800 15XX	Beşli Yatay Çerçeve	10	50	18,06	29,332	30,13
2125 800 16XX	Altılı Yatay Çerçeve	10	50	21,20	38,142	39,78
2125 800 22XX	İkili Dikey Çerçeve	10	50	9,90	11,738	16,43
2125 800 23XX	Üçlü Dikey Çerçeve	10	50	12,90	20,584	22,23
2125 800 24XX	Dörtlü Dikey Çerçeve	10	50	15,90	24,618	27,43
2125 800 25XX	Beşli Dikey Çerçeve	10	50	18,06	29,332	30,13
2125 800 26XX	Altılı Dikey Çerçeve	10	50	21,20	38,142	39,78
2125 820 12XX	İkili Priz Çerçeve	12	60	3,80	6,22	11,05
2100 000 11XX	Sıva Üstü Kasa	12	60	5,43	12,88	14,20
2200 000 0001	IP44 Kapaklı Priz Conta (Resmi Sayfa 28'de)	24	120	4,00	—	—

İngiliz Tip

2190 500 0201	İngiliz Tipi Anahtarlı Priz Beyaz	12	120	—	—	43,47
---------------	-----------------------------------	----	-----	---	---	-------



YENİ



► RİTA MODÜLER SİSTEM

Kod	Ürün Tanımı	Kutu Adedi	Fiyat
2200 250 01XX	Mek+Tuş Speakhone Prizi	1	MÜŞTERİ TEMSİLCİSİNE FİYAT SORUNUZ.
2200 251 01XX	Mek+Tuş RCA Prizi	1	
2200 252 01XX	Mek+Tuş 3,5 Ses Jaki	1	
2200 253 01XX	Mek+Tuş XLR Erkek Prizi	1	
2200 254 01XX	Mek+Tuş XLR Dişi Prizi	1	
2200 255 01XX	Mek+Tuş Usb Printer Prizi	1	

► ENERGY SAVER ÜRÜN LİSTESİ

Kod	Ürün Tanımı	Kutu Adedi	Fiyat
2100 852 0000	İki Röleli(30A+16A)Energy Saver Röle Ünitesi(VRF/FC) -Kutulu, Panoda 4 modül yer kaplar, 1 klima odalar içindir	1	MÜŞTERİ TEMSİLCİSİNE FİYAT SORUNUZ.
2100 853 0000	Üç Röleli(30A+2x16A)Energy Saver Röle Ünitesi(VRF/FC) -Kutulu, Panoda 6 modül yer kaplar, 2 klima odalar içindir	1	
2100 854 0000	İki Röleli(30A+16A)Energy Saver DND Röle Ünitesi(VRF/FC) (DND/MUR kontrolü için ünite olarak vavien komütatör kullanılması şarttır) -Kutulu, Panoda 6 modül yer kaplar, 1 klima odalar içindir	1	
2100 855 0000	Üç Röleli(30A+16A)Energy Saver DND Röle Ünitesi(VRF/FC) (DND/MUR kontrolü için ünite olarak vavien komütatör kullanılması şarttır) -Kutulu, Panoda 6 modül yer kaplar, 1 klima odalar içindir	1	
2110 052 0001	Energy Saver Kapak	1	
2100 012 01XX	Mek+Tuş Impuls Anahtar	12	
2100 023 01XX	Mek+Tuş Impuls Komütatör	12	
2100 024 01XX	Mek+Tuş Impuls Işıklı Anahtar (220V)	12	
2100 027 01XX	Mek+Tuş Impuls Işıklı Komütatör	12	
2125 010 0101	Otel Uyarı İç Ünitesi Komütatörü (Mekanik) Işıklı	12	
2220 010 0101	Rita Otel Uyarı İç Ünitesi Komütatörü (Mekanik) Işıklı	12	
2220 010 0201	Rita Otel Uyarı İç Ünitesi Komütatörü (Mekanik) Işıklı Vidalı	12	
2200 412 01XX	Rita Mek Tuş Impuls Anahtar (Klipsli)	12	
2200 412 02XX	Rita Mek Tuş Impuls Anahtar (Vidalı)	12	
2200 423 01XX	Rita Mek Tuş Impuls Komütatör (Klipsli)	12	
2200 423 02XX	Rita Mek Tuş Impuls Komütatör (Vidalı)	12	
2200 424 01XX	Rita Mek Tuş Impuls Işıklı Anahtar(Klipsli)	12	
2200 424 02XX	Rita Mek Tuş Impuls Işıklı Anahtar (Vidalı)	12	
2200 427 01XX	Rita Mek Tuş Impuls Işıklı Komütatör (Klipsli)	12	
2200 427 02XX	Rita Mek Tuş Impuls Işıklı Komütatör (Vidalı)	12	



01 Beyaz
02 Krem

BRON Natural

Sıva Üstü Anahtar Priz Serisi

Beyaz / Krem Ürün Listesi

Kod	Ürün Tanımı	Kutu Adedi	Koli Adedi	Fiyat
2160 301 02XX	Bron S/Ü Anahtar	12	120	10,51
2160 302 02XX	Bron S/Ü Komütatör	12	120	12,72
2160 303 02XX	Bron S/Ü Vavien	12	120	12,14
2160 307 02XX	Bron S/Ü Light (Çağırma)	12	120	10,74
2160 315 02XX	Bron S/Ü Işıklı Anahtar (220V)	12	120	19,44
2160 316 02XX	Bron S/Ü Işıklı Vavien (220V)	12	120	21,12
2160 317 02XX	Bron S/Ü Işıklı Light (Çağırma) (220V)	12	120	19,60
2160 326 02XX	Bron S/Ü Işıklı Komütatör	12	120	23,29
2160 100 02XX	Bron S/Ü Topraklı Priz	12	120	12,72
2160 101 02XX	Bron S/Ü Topraksız Priz	12	120	12,67
2160 103 02XX	Bron S/Ü Top.lı Priz Porselen	12	120	15,83
2160 104 02XX	Bron S/Ü Top.sız Priz Porselen	12	120	13,79
2160 110 02XX	Bron S/Ü Kapaklı Top.lı Priz	10	100	15,26
2160 113 02XX	Bron S/Ü Kapaklı Top.lı Priz Porselen	10	100	18,27
2160 115 02XX	Bron S/Ü Ups (Fransız) Priz	12	120	13,44
2160 125 02XX	Bron S/Ü Telefon Prizi 1 *Rj12 Cat3	12	120	16,99
2160 136 02XX	Bron S/Ü Data Prizi 1 *Rj45 (Cat5)	12	120	18,37
2160 166 02XX	Bron S/Ü Sat Prizi (Geçişli) 4Db/F Konnektör	12	120	40,29
2160 167 02XX	Bron S/Ü Sat Prizi (Sonlu)	12	120	34,91
2160 170 02XX	Bron S/Ü Tv Prizi (Geçişli)	12	120	32,09
2160 171 02XX	Bron S/Ü Tv Prizi (Sonlu)	12	120	32,28
2160 200 02XX	Bron S/Ü İkili Top.lı Priz Porselen	6	60	22,96
2160 201 02XX	Bron İkili Topraksız Priz Porselen	6	60	18,86
2160 202 02XX	Bron S/Ü İkili Topraklı Priz	6	60	19,36
2160 203 02XX	Bron S/Ü İkili Topraksız Priz	6	60	15,78
2160 215 02XX	Bron S/Ü İkili Ups (Fransız) Priz	6	60	19,34



58 Meşe
57 Ceviz

BRON Ahşap

Sıva Üstü Anahtar Priz Serisi

Meşe / Ceviz Ürün Listesi

Kod	Ürün Tanımı	Kutu Adedi	Koli Adedi	Fiyat
2160 301 02XX	Bron S/Ü Anahtar	12	120	18,66
2160 302 02XX	Bron S/Ü Komütatör	12	120	20,86
2160 303 02XX	Bron S/Ü Vavien	12	120	20,74
2160 307 02XX	Bron S/Ü Light (Çağırma)	12	120	18,95
2160 315 02XX	Bron S/Ü Işıklı Anahtar (220V)	12	120	27,52
2160 316 02XX	Bron S/Ü Işıklı Vavien (220V)	12	120	28,50
2160 317 02XX	Bron S/Ü Işıklı Light (Çağırma) (220V)	12	120	27,76
2160 326 02XX	Bron S/Ü Işıklı Komütatör	12	120	30,22
2160 100 02XX	Bron S/Ü Topraklı Priz	12	120	25,46
2160 101 02XX	Bron S/Ü Topraksız Priz	12	120	18,83
2160 103 02XX	Bron S/Ü Top.lı Priz Porselen	12	120	21,92
2160 104 02XX	Bron S/Ü Top.sız Priz Porselen	12	120	20,08
2160 110 02XX	Bron S/Ü Kapaklı Top.lı Priz	10	100	24,75
2160 113 02XX	Bron S/Ü Kapaklı Top.lı Priz Porselen	10	100	27,26
2160 115 02XX	Bron S/Ü Ups (Fransız) Priz	12	120	20,08
2160 125 02XX	Bron S/Ü Telefon Prizi 1 *Rj12 (Cat3)	12	120	27,88
2160 136 02XX	Bron S/Ü Data Prizi 1 *Rj45 (Cat5)	12	120	40,41
2160 166 02XX	Bron S/Ü Sat Prizi (Geçişli) 4Db/F Konnektör	12	120	39,69
2160 167 02XX	Bron S/Ü Sat Prizi (Sonlu)	12	120	35,08
2160 170 02XX	Bron S/Ü Tv Prizi (Geçişli)	12	120	38,92
2160 171 02XX	Bron S/Ü Tv Prizi (Sonlu)	12	120	39,11
2160 200 02XX	Bron S/Ü İkili Top.lı Priz Porselen	6	60	37,40
2160 201 02XX	Bron İkili Topraksız Priz Porselen	6	60	29,00
2160 202 02XX	Bron S/Ü İkili Topraklı Priz	6	60	35,41
2160 203 02XX	Bron S/Ü İkili Topraksız Priz	6	60	27,48
2160 215 02XX	Bron S/Ü İkili Ups (Fransız) Priz	6	60	37,49

Nemliyer



Güvenliđi arttırılmıř,
sıva üstü anahtar serimiz...



Nemliyer Natural

Beyaz / Gri Ürün Listesi

Kod	Ürün Tanımı	Kutu Adedi	Koli Adedi	Fiyat
2150 001 01XX	Anahtar Nemliyer	10	100	20,04
2150 002 01XX	Komütatör Nemliyer	10	100	22,00
2150 003 01XX	Vavien(İki Yollu Anahtar) Nemliyer	10	100	22,00
2150 005 01XX	Çift Kutup. Anahtar Nemliyer	10	100	21,91
2150 007 01XX	Çağırma Nemliyer	10	100	19,93
2150 008 01XX	Deviatör(Ara Vavien) Nemliyer	10	100	25,19
2150 110 02XX	Kap.lı Top.lı Priz Nemliyer	8	80	19,97
2150 115 02XX	Ups Kapaklı Top.lı Priz Nemliyer	8	80	20,94
2150 125 02XX	Telefon Prizi 1 *Rj12 Nemliyer	10	100	17,75
2150 136 01XX	Data Prizi 1 *Rj45 (Cat5e) Nemliyer	10	100	22,65
2150 166 02XX	Sat Prizi (Geçişli) Nemliyer	10	100	36,18
2150 167 02XX	Sat Prizi (Sonlu) Nemliyer	10	100	36,18
2150 170 02XX	Tv Prizi (Geçişli) Nemliyer	10	100	32,81
2150 171 02XX	Tv Prizi (Sonlu) Nemliyer	10	100	32,81



Beyaz-01



Gri-03



Nemliyer Ahşap

Ahşap Ürün Listesi

Kod	Ürün Tanımı	Kutu Adedi	Koli Adedi	Fiyat
2150 001 01XX	Anahtar Nemliyer Ahşap	10	100	26,98
2150 002 01XX	Komütatör Nemliyer Ahşap	10	100	30,24
2150 003 01XX	Vavien(İki Yollu Anahtar) Nemliyer Ahşap	10	100	28,94
2150 005 01XX	Çift Kutup. Anahtar Nemliyer Ahşap	10	100	28,85
2150 007 01XX	Çağırma Nemliyer Ahşap	10	100	27,38
2150 008 01XX	Deviatör(Ara Vavien) Nemliyer Ahşap	10	100	32,13
2150 110 02XX	Kap.lı Top.lı Priz Nemliyer Ahşap	8	80	31,60
2150 115 02XX	Ups Kapaklı Top.lı Priz Nemliyer Ahşap	8	80	34,27
2150 125 02XX	Telefon Prizi 1 *Rj12 Cat3 Nemliyer Ahşap	10	100	19,92
2150 136 01XX	Data Prizi 1 *Rj45 (Cat5e) Nemliyer Ahşap	10	100	29,92
2150 166 02XX	Sat Prizi (Geçişli) Nemliyer Ahşap	10	100	40,66
2150 167 02XX	Sat Prizi (Sonlu) Nemliyer Ahşap	10	100	40,81
2150 170 02XX	Tv Prizi (Geçişli) Nemliyer Ahşap	10	100	36,59
2150 171 02XX	Tv Prizi (Sonlu) Nemliyer Ahşap	10	100	36,59

MUT-40
AÇIK KAYINMUT-41
KOYU CEVİZMUT-43
MERBAUMUT-44
MAUNMUT-49
ARMUT



Fiş Prizler Grup Prizler

Pratik...

Şok korumalı, 2'li USB şarjlı, anahtarlı, anahtarsız, UPS, kablolu, klemensli, ikili, üçlü, dörtlü, altılı seçenekleriyle taşınabilir enerji ihtiyacınızı karşılayacak...



**New
YENİ**

Ri-tech Grup Prizler

Ürün Listesi

Kod	Ürün Tanımı	Kutu Adedi	Fiyat
001 175 220001 00 00	İKİLİ ANAHT. TOP.LI GRUP PRİZ(Ç.K.)(KLEMENSLİ)	25	33,00
001 175 220002 01 00	İKİLİ ANAHT. TOP.LI GRUP PRİZ(Ç.K.)(1 MT)	12	44,81
001 175 220002 02 00	İKİLİ ANAHT. TOP.LI GRUP PRİZ(Ç.K.)(2 MT)	12	52,10
001 175 220002 03 00	İKİLİ ANAHT. TOP.LI GRUP PRİZ(Ç.K.)(3 MT)	12	58,50
001 175 220002 05 00	İKİLİ ANAHT. TOP.LI GRUP PRİZ(Ç.K.)(5 MT)	12	73,00
001 175 320001 00 00	ÜÇLÜ ANAHT. TOP.LI GRUP PRİZ(Ç.K.)(KLEMENSLİ)	25	35,50
001 175 320002 01 00	ÜÇLÜ ANAHT. TOP.LI GRUP PRİZ(Ç.K.)(1 MT)	12	47,50
001 175 320002 02 00	ÜÇLÜ ANAHT. TOP.LI GRUP PRİZ(Ç.K.)(2 MT)	12	54,00
001 175 320002 03 00	ÜÇLÜ ANAHT. TOP.LI GRUP PRİZ(Ç.K.)(3 MT)	12	61,90
001 175 320002 05 00	ÜÇLÜ ANAHT. TOP.LI GRUP PRİZ(Ç.K.)(5 MT)	12	75,60
001 175 420001 00 00	DÖRTLÜ ANAHT. TOP.LI GRUP PRİZ(Ç.K.)(KLEMENSLİ)	25	41,50
001 175 420002 01 00	DÖRTLÜ ANAHT. TOP.LI GRUP PRİZ(Ç.K.)(1 MT)	12	57,00
001 175 420002 02 00	DÖRTLÜ ANAHT. TOP.LI GRUP PRİZ(Ç.K.)(2 MT)	12	62,50
001 175 420002 03 00	DÖRTLÜ ANAHT. TOP.LI GRUP PRİZ(Ç.K.)(3 MT)	12	70,00
001 175 420002 05 00	DÖRTLÜ ANAHT. TOP.LI GRUP PRİZ(Ç.K.)(5 MT)	12	82,40
001 175 620001 00 00	ALTILI ANAHT. TOP.LI GRUP PRİZ(Ç.K.)(KLEMENSLİ)	25	48,00
001 175 620002 01 00	ALTILI ANAHT. TOP.LI GRUP PRİZ(Ç.K.)(1 MT)	12	68,75
001 175 620002 02 00	ALTILI ANAHT. TOP.LI GRUP PRİZ(Ç.K.)(2 MT)	12	72,00
001 175 620002 03 00	ALTILI ANAHT. TOP.LI GRUP PRİZ(Ç.K.)(3 MT)	12	81,50
001 175 620002 05 00	ALTILI ANAHT. TOP.LI GRUP PRİZ(Ç.K.)(5 MT)	12	99,90
001 175 340001 00 00	ÜÇLÜ ANAHT. UPS GRUP PRİZ(Ç.K.)(KLEMENSLİ)	25	38,00
001 175 340002 02 00	ÜÇLÜ ANAHT. UPS GRUP PRİZ(Ç.K.)(2 MT)	12	55,90
001 175 340002 03 00	ÜÇLÜ ANAHT. UPS GRUP PRİZ(Ç.K.)(3 MT)	12	65,00
001 175 340002 05 00	ÜÇLÜ ANAHT. UPS GRUP PRİZ(Ç.K.)(5 MT)	12	79,50
001 175 350001 00 00	ÜÇLÜ USB ANAHT. TOP.LI GRUP PRİZ(Ç.K.)(KLEMENSLİ)	25	77,07
001 175 350002 02 00	ÜÇLÜ USB ANAHT. TOP.LI GRUP PRİZ(Ç.K.)(2 MT)	12	98,07
001 175 350002 03 00	ÜÇLÜ USB ANAHT. TOP.LI GRUP PRİZ(Ç.K.)(3 MT)	12	105,53
001 175 350002 05 00	ÜÇLÜ USB ANAHT. TOP.LI GRUP PRİZ(Ç.K.)(5 MT)	12	119,28
001 175 440001 00 00	DÖRTLÜ ANAHT. UPS GRUP PRİZ(Ç.K.)(KLEMENSLİ)	25	43,00
001 175 440002 02 00	DÖRTLÜ ANAHT. UPS GRUP PRİZ(Ç.K.)(2 MT)	12	63,50
001 175 440002 03 00	DÖRTLÜ ANAHT. UPS GRUP PRİZ(Ç.K.)(3 MT)	12	69,90
001 175 440002 05 00	DÖRTLÜ ANAHT. UPS GRUP PRİZ(Ç.K.)(5 MT)	12	83,90
001 175 640001 00 00	ALTILI ANAHT. UPS GRUP PRİZ(Ç.K.)(KLEMENSLİ)	25	50,50
001 175 640002 02 00	ALTILI ANAHT. UPS GRUP PRİZ(Ç.K.)(2 MT)	12	74,50
001 175 640002 03 00	ALTILI ANAHT. UPS GRUP PRİZ(Ç.K.)(3 MT)	12	82,90
001 175 640002 05 00	ALTILI ANAHT. UPS GRUP PRİZ(Ç.K.)(5 MT)	12	102,50
001 175 650001 00 00	ALTILI USB ANAHT. TOP.LI GRUP PRİZ(Ç.K.)(KLEMENSLİ)	25	92,19
001 175 650002 02 00	ALTILI USB ANAHT. TOP.LI GRUP PRİZ(Ç.K.)(2 MT)	12	119,18
001 175 650002 03 00	ALTILI USB ANAHT. TOP.LI GRUP PRİZ(Ç.K.)(3 MT)	12	129,26
001 175 650002 05 00	ALTILI USB ANAHT. TOP.LI GRUP PRİZ(Ç.K.)(5 MT)	12	149,42
001 175 210001 00 00	İKİLİ TOP.LI GRUP PRİZ(Ç.K.)(KLEMENSLİ)	25	14,90
001 175 210002 01 00	İKİLİ TOP.LI GRUP PRİZ(Ç.K.)(1 MT)	12	26,32
001 175 210002 02 00	İKİLİ TOP.LI GRUP PRİZ(Ç.K.)(2 MT)	12	32,00
001 175 210002 03 00	İKİLİ TOP.LI GRUP PRİZ(Ç.K.)(3 MT)	12	37,50
001 175 210002 05 00	İKİLİ TOP.LI GRUP PRİZ(Ç.K.)(5 MT)	12	49,00
001 175 310001 00 00	ÜÇLÜ TOP.LI GRUP PRİZ(Ç.K.)(KLEMENSLİ)	25	16,80
001 175 310002 01 00	ÜÇLÜ TOP.LI GRUP PRİZ(Ç.K.)(1 MT)	12	29,00
001 175 310002 02 00	ÜÇLÜ TOP.LI GRUP PRİZ(Ç.K.)(2 MT)	12	34,30
001 175 310002 03 00	ÜÇLÜ TOP.LI GRUP PRİZ(Ç.K.)(3 MT)	12	39,90
001 175 310002 05 00	ÜÇLÜ TOP.LI GRUP PRİZ(Ç.K.)(5 MT)	12	51,50
001 175 410001 00 00	DÖRTLÜ TOP.LI GRUP PRİZ(Ç.K.)(KLEMENSLİ)	25	21,70
001 175 410002 01 00	DÖRTLÜ TOP.LI GRUP PRİZ(Ç.K.)(1 MT)	12	32,52
001 175 410002 02 00	DÖRTLÜ TOP.LI GRUP PRİZ(Ç.K.)(2 MT)	12	41,00
001 175 410002 03 00	DÖRTLÜ TOP.LI GRUP PRİZ(Ç.K.)(3 MT)	12	47,00
001 175 410002 05 00	DÖRTLÜ TOP.LI GRUP PRİZ(Ç.K.)(5 MT)	12	59,90
001 175 610001 00 00	ALTILI TOP.LI GRUP PRİZ(Ç.K.)(KLEMENSLİ)	25	33,75
001 175 610002 01 00	ALTILI TOP.LI GRUP PRİZ(Ç.K.)(1 MT)	12	49,10
001 175 610002 02 00	ALTILI TOP.LI GRUP PRİZ(Ç.K.)(2 MT)	12	50,00
001 175 610002 03 00	ALTILI TOP.LI GRUP PRİZ(Ç.K.)(3 MT)	12	60,20
001 175 610002 05 00	ALTILI TOP.LI GRUP PRİZ(Ç.K.)(5 MT)	12	78,30



Ri-tech Grup Prizler

Ürün Listesi

Kod	Ürün Tanımı	Kutu Adedi	Fiyat
001 175 330001 00 00	ÜÇLÜ UPS GRUP PRİZ(Ç.K.)(KLEMENSLİ)	25	23,00
001 175 330002 02 00	ÜÇLÜ UPS GRUP PRİZ(Ç.K.)(2 MT)	12	38,00
001 175 330002 03 00	ÜÇLÜ UPS GRUP PRİZ(Ç.K.)(3 MT)	12	45,50
001 175 330002 05 00	ÜÇLÜ UPS GRUP PRİZ(Ç.K.)(5 MT)	12	58,00
001 175 430001 00 00	DÖRTLÜ UPS GRUP PRİZ(Ç.K.)(KLEMENSLİ)	25	34,00
001 175 430002 02 00	DÖRTLÜ UPS GRUP PRİZ(Ç.K.)(2 MT)	12	47,00
001 175 430002 03 00	DÖRTLÜ UPS GRUP PRİZ(Ç.K.)(3 MT)	12	57,00
001 175 430002 05 00	DÖRTLÜ UPS GRUP PRİZ(Ç.K.)(5 MT)	12	69,00
001 175 630001 00 00	ALTILI UPS GRUP PRİZ(Ç.K.)(KLEMENSLİ)	25	48,00
001 175 630002 02 00	ALTILI UPS GRUP PRİZ(Ç.K.)(2 MT)	12	69,00
001 175 630002 03 00	ALTILI UPS GRUP PRİZ(Ç.K.)(3 MT)	12	76,00
001 175 630002 05 00	ALTILI UPS GRUP PRİZ(Ç.K.)(5 MT)	12	91,00

Ri-tech Akım (Şok) korumalı Grup Priz

Kod	Ürün Tanımı	Kutu Adedi	Fiyat
001 175 660002 15 00	ALTILI ŞOK.KOR. USB ANAHT. TOP.LI GRUP PRİZ(Ç.K.) (3X1.5 1.5 MT)	12	157,30
001 175 670002 15 00	ALTILI ŞOK.KOR. ANAHT. TOP.LI GRUP PRİZ(Ç.K.) (3X1.5 1.5 MT)	12	118,80

Ri-tech USB Şarj

Kod	Ürün Tanımı	Kutu Adedi	Fiyat
001 888 100002 00 00	2'Li USB ŞARJ ADAPTÖR 2,4A	20	52,50

New
YENİ



New
YENİ



Olimpia Grup Prizler

Ürün Listesi



Kod	Ürün Tanımı	Kutu Adedi	Fiyat
001 171 290001 00 00	İkili Topraksız Grup Priz (Klemensli) Olimpia	25	9,31
001 171 290002 02 00	İkili Topraksız Grup Priz (2Mt) Olimpia	12	22,58
001 171 290002 03 00	İkili Topraksız Grup Priz (3Mt) Olimpia	12	24,27
001 171 290002 05 00	İkili Topraksız Grup Priz (5Mt) Olimpia	12	31,29



001 171 390001 00 00	Üçlü Topraksız Grup Priz (Klemensli) Olimpia	25	13,45
001 171 390002 02 00	Üçlü Topraksız Grup Priz (2Mt) Olimpia	12	26,64
001 171 390002 03 00	Üçlü Topraksız Grup Priz(3Mt) Olimpia	12	28,32
001 171 390002 05 00	Üçlü Topraksız Grup Priz (5Mt) Olimpia	12	35,32



001 171 210001 00 00	İkili Topraklı Grup Priz (Klemensli) Olimpia	25	12,41
001 171 210002 02 00	İkili Topraklı Grup Priz (2Mt) Olimpia	12	30,19
001 171 210002 03 00	İkili Topraklı Grup Priz (3M) Olimpia	12	36,23
001 171 210002 05 00	İkili Topraklı Grup Priz (5M) Olimpia	12	48,81



001 171 310001 00 00	Üçlü Grup Priz Topraklı (Klemensli) Olimpia	25	15,50
001 171 310002 02 00	Üçlü Topraklı Grup Priz (2Mt) Olimpia	12	33,60
001 171 310002 03 00	Üçlü Topraklı Grup Priz (3Mt) Olimpia	12	37,90
001 171 310002 05 00	Üçlü Topraklı Grup Priz (5Mt) Olimpia	12	49,90
001 171 320001 00 00	Üçlü Topraklı Grup Priz (Klemensli Anahtarlı) Olimpia	25	26,00
001 171 320002 02 00	Üçlü Topraklı Grup Priz (Anahtarlı 2 Mt) Olimpia	12	41,50
001 171 320002 03 00	Üçlü Topraklı Grup Priz (Anahtarlı 3 Mt) Olimpia	12	49,10
001 171 320002 05 00	Üçlü Topraklı Grup Priz (Anahtarlı 5 Mt) Olimpia	12	65,50
001 171 340001 00 00	Üçlü Ups Grup Priz (Klemensli) Olimpia	25	18,54
001 171 330001 02 00	Üçlü Ups Grup Priz (2Mt) Olimpia	12	35,10
001 171 330001 03 00	Üçlü Ups Grup Priz (3Mt) Olimpia	12	43,20
001 171 330001 05 00	Üçlü Ups Grup Priz (5Mt) Olimpia	12	56,40



001 171 410001 00 00	Dörtlü Topraklı Grup Priz (Klemensli) Olimpia	25	19,00
001 171 410001 02 00	Dörtlü Topraklı Grup Priz (2Mt) Olimpia	12	37,88
001 171 410001 03 00	Dörtlü Topraklı Grup Priz (3Mt) Olimpia	12	44,20
001 171 410001 05 00	Dörtlü Topraklı Grup Priz (5Mt) Olimpia	12	56,80
001 171 410002 00 00	Dörtlü Topraklı Grup Priz (Klemensli-Anah. Olimpia)	25	27,00
001 171 410002 02 00	Dörtlü Topraklı Grup Priz (Anahtarlı 2 Mt) Olimpia	12	46,20
001 171 410002 03 00	Dörtlü Topraklı Grup Priz (Anahtarlı 3 Mt) Olimpia	12	52,01
001 171 410002 05 00	Dörtlü Topraklı Grup Priz (Anahtarlı 5 Mt) Olimpia	12	67,20



001 171 610001 00 00	Altılı Grup Priz Top.ıı (Klemensli) Olimpia	25	30,50
001 171 610001 02 00	Altılı Topraklı Grup Priz (2 Mt) Olimpia	12	48,90
001 171 610001 03 00	Altılı Topraklı Grup Priz (3 Mt) Olimpia	12	58,50
001 171 610001 05 00	Altılı Topraklı Grup Priz (5 Mt) Olimpia	12	75,40
001 171 610002 00 00	Altılı Topraklı Grup Priz (Klemensli-Anahtarlı) Olimpia	25	36,00
001 171 610002 02 00	Altılı Topraklı Grup Priz (Anahtarlı 2 Mt) Olimpia	12	58,53
001 171 610002 03 00	Altılı Topraklı Grup Priz (Anahtarlı 3 Mt) Olimpia	12	69,36
001 171 610002 05 00	Altılı Topraklı Grup Priz (Anahtarlı 5 Mt) Olimpia	12	91,05



001 170 110001 00 00	10 lu Topraklı Grup Priz (Klemensli)	20	69,24
----------------------	--------------------------------------	----	-------

Fiş Prizler

Ürün Listesi



CE

Ürün Kodu	001 170 012001 00 00
Ürün Adı	Topraklı Erkek Fiş (Kuyruklu)
Kutu Adedi	50
Fiyatı	4,80



CE

Ürün Kodu	001 170 010001 00 00
Ürün Adı	Erkek Fiş
Kutu Adedi	50
Fiyatı	4,32



CE

Ürün Kodu	001 170 013001 00 00
Ürün Adı	Topraklı Erkek Fiş Ups (Kuyruklu)
Kutu Adedi	50
Fiyatı	5,20



CE

Ürün Kodu	001 170 020001 00 00
Ürün Adı	Dişi Fiş
Kutu Adedi	50
Fiyatı	3,25



CE

Ürün Kodu	001 170 011001 00 00
Ürün Adı	Topraklı Erkek Fiş
Kutu Adedi	50
Fiyatı	5,85



CE

Ürün Kodu	001 170 021001 00 00
Ürün Adı	Topraklı Dişi Fiş
Kutu Adedi	25
Fiyatı	6,45



CE

Ürün Kodu	001 170 014001 00 00
Ürün Adı	Topraklı Erkek Fiş Ups
Kutu Adedi	50
Fiyatı	6,85



CE

Ürün Kodu	001 170 011002 00 00
Ürün Adı	Kulplu Topraklı Erkek Fiş
Kutu Adedi	50
Fiyatı	5,99



CE

Ürün Kodu	001 170 051001 00 00
Ürün Adı	Topraklı Erkek Fiş
Kutu Adedi	50
Fiyatı	6,35



CE

Ürün Kodu	001 170 061001 00 00
Ürün Adı	Topraklı Dişi Fiş
Kutu Adedi	25
Fiyatı	7,09



CE

Ürün Kodu	001 170 050001 00 00
Ürün Adı	Erkek Fiş
Kutu Adedi	50
Fiyatı	4,65



CE

Ürün Kodu	001 170 060001 00 00
Ürün Adı	Dişi Fiş
Kutu Adedi	50
Fiyatı	3,30

Fiş Prizler

Ürün Listesi



CE

Ürün Kodu	001 170 033001 00 00
Ürün Adı	Topraklı Üçlü Fiş-Priz (Yonca Tip) (S/Å)
Kutu Adedi	12
Fiyatı	20,56



Ürün Kodu	001 888 000001 00 00
Ürün Adı	Prizmatik Çocuk Koruma Kapağı
Kutu Adedi	100
Fiyatı	4,06



CE

Ürün Kodu	001 170 033002 00 00
Ürün Adı	Topraklı Üçlü Fiş-Priz (Yonca Tip) (S/Ü)
Kutu Adedi	20
Fiyatı	20,00



CE

Ürün Kodu	001 170 033003 00 00
Ürün Adı	İkili Topraklı Fiş-Priz (Düz Tip)
Kutu Adedi	24
Fiyatı	22,61



Ürün Kodu	001 170 030002 00 00
Ürün Adı	Adaptör Fiş, Priz (İngiliz Tip)
Kutu Adedi	50
Fiyatı	1,33 USD



CE

Ürün Kodu	001 170 033005 00 00
Ürün Adı	Üçlü Topraklı Fiş-Priz (Düz Tip)
Kutu Adedi	24
Fiyatı	27,60



CE

Ürün Kodu	001 170 030001 00 00
Ürün Adı	Arapuar Anahtar
Kutu Adedi	50
Fiyatı	4,47



CE

Ürün Kodu	001 170 033004 00 00
Ürün Adı	Üçlü Topraklı Fiş-Priz (Düz Tip Anahtarlı)
Kutu Adedi	24
Fiyatı	37,80

Çocuk Korumasız
Prizlerinizin
Çözümü



IP44
Kapaklı Priz Conta ile
Daha Güvende..



SİGORTA KUTULARI

Kalite ve İleri Teknolojinin Keyfini Yaşayın...





Sıva altı serisinde **betopan,**
alçıpan duvarlara montaj
yapılabilme özelliği.



Kod	Açıklama / Stok Cinsi	Amb. (Kutu)	Amb. Birimi	FİYAT
-----	-----------------------	-------------	-------------	-------

COMFORT W OTOMAT KUTULARI

IP40

001 057 200001 00 00	COMFORT MÜH. SİGORTA KUTUSU(S/Ü) 1 Lİ	20 ad.	120	4,29
001 057 200002 00 00	COMFORT MÜH. SİGORTA KUTUSU(S/Ü) 1-2 Lİ	20 ad.	80	4,90
001 057 200004 00 00	COMFORT MÜH. SİGORTA KUTUSU(S/Ü) 2-4 Lİ	10 ad.	60	6,03
001 057 100006 00 00	COMFORT SİGORTA KUTUSU (S/Ü) 6 Lİ	1 ad.	20	38,76
001 057 100009 00 00	COMFORT SİGORTA KUTUSU (S/Ü) 9 LU	1 ad.	20	47,17
001 057 100012 00 00	COMFORT SİGORTA KUTUSU (S/Ü) 12 Lİ	1 ad.	10	63,61
001 057 100018 00 00	COMFORT SİGORTA KUTUSU (S/Ü) 18 Lİ	1 ad.	10	85,19
001 057 100024 00 00	COMFORT SİGORTA KUTUSU (S/Ü) 24 LÜ	1 ad.	5	94,69
001 057 100036 00 00	COMFORT SİGORTA KUTUSU (S/Ü) 36 Lİ	1 ad.	5	118,96
001 057 000006 00 00	COMFORT SİGORTA KUTUSU (S/A) 6 Lİ	1 ad.	20	39,26
001 057 000009 00 00	COMFORT SİGORTA KUTUSU (S/A) 9 LU	1 ad.	20	46,28
001 057 000012 00 00	COMFORT SİGORTA KUTUSU (S/A) 12 Lİ	1 ad.	10	59,33
001 057 000018 00 00	COMFORT SİGORTA KUTUSU (S/A) 18 Lİ	1 ad.	10	80,89
001 057 000024 00 00	COMFORT SİGORTA KUTUSU (S/A) 24 LÜ	1 ad.	5	89,69
001 057 000036 00 00	COMFORT SİGORTA KUTUSU (S/A) 36 Lİ	1 ad.	5	111,13

COMFORT W OTOMAT KUTULARI (ALEV YAYMAYAN)

TSE CE IP40

001 057 210001 00 00	COMFORT MÜH. SİGORTA (A.YAYMAYAN)(S/Ü) 1 Lİ	20 ad.	120	8,06
001 057 210002 00 00	COMFORT MÜH. SİGORTA (A.YAYMAYAN)(S/Ü) 1-2 Lİ	20 ad.	80	9,35
001 057 210004 00 00	COMFORT MÜH. SİGORTA (A.YAYMAYAN)(S/Ü) 2-4 LÜ	10 ad.	60	11,28
001 057 110006 00 00	COMFORT SİGORTA KUTUSU(S/Ü)(A.YAYMAYAN) 6 Lİ	1 ad.	20	49,43
001 057 110009 00 00	COMFORT SİGORTA KUTUSU(S/Ü)(A.YAYMAYAN) 9 LU	1 ad.	20	59,50
001 057 110012 00 00	COMFORT SİGORTA KUTUSU(S/Ü)(A.YAYMAYAN) 12 Lİ	1 ad.	10	78,83
001 057 110018 00 00	COMFORT SİGORTA KUTUSU(S/Ü)(A.YAYMAYAN) 18 Lİ	1 ad.	10	117,13
001 057 110024 00 00	COMFORT SİGORTA KUTUSU(S/Ü)(A.YAYMAYAN) 24 LÜ	1 ad.	5	125,24
001 057 110036 00 00	COMFORT SİGORTA KUTUSU(S/Ü)(A.YAYMAYAN) 36 Lİ	1 ad.	5	155,37
001 057 010006 00 00	COMFORT SİGORTA KUTUSU(S/A) A.YAYMAYAN 6 Lİ	1 ad.	20	48,29
001 057 010009 00 00	COMFORT SİGORTA KUTUSU(S/A) A.YAYMAYAN 9 LU	1 ad.	20	57,77
001 057 010012 00 00	COMFORT SİGORTA KUTUSU(S/A) A.YAYMAYAN 12 Lİ	1 ad.	10	77,14
001 057 010018 00 00	COMFORT SİGORTA KUTUSU(S/A) A.YAYMAYAN 18 Lİ	1 ad.	10	107,84
001 057 010024 00 00	COMFORT SİGORTA KUTUSU(S/A) A.YAYMAYAN 24 LÜ	1 ad.	5	117,06
001 057 010036 00 00	COMFORT SİGORTA KUTUSU(S/A) A.YAYMAYAN 36 Lİ	1 ad.	5	149,10

COMFORT W OTOMAT KUTULARI H.FREE (ALEV YAYAN)

IP40

HF

001 057 220001 00 00	COMFORT MÜH. SİGORTA KUTUSU H.FREE (ALEV YAYAN)(S/Ü) 1 Lİ	20 ad.	120	5,31
001 057 220002 00 00	COMFORT MÜH. SİGORTA KUTUSU H.FREE (ALEV YAYAN)(S/Ü) 1-2 Lİ	20 ad.	80	6,33
001 057 220004 00 00	COMFORT MÜH. SİGORTA KUTUSU H.FREE (ALEV YAYAN)(S/Ü) 2-4 Lİ	10 ad.	60	7,51
001 057 120006 00 00	COMFORT SİGORTA KUTUSU H.FREE (ALEV YAYAN) (S/Ü) 6 Lİ	1 ad.	20	40,05
001 057 120009 00 00	COMFORT SİGORTA KUTUSU H.FREE (ALEV YAYAN) (S/Ü) 9 LU	1 ad.	20	59,77
001 057 120012 00 00	COMFORT SİGORTA KUTUSU H.FREE (ALEV YAYAN) (S/Ü) 12 Lİ	1 ad.	10	79,53
001 057 120018 00 00	COMFORT SİGORTA KUTUSU H.FREE (ALEV YAYAN) (S/Ü) 18 Lİ	1 ad.	10	111,92
001 057 120024 00 00	COMFORT SİGORTA KUTUSU H.FREE (ALEV YAYAN) (S/Ü) 24 LÜ	1 ad.	5	115,70
001 057 120036 00 00	COMFORT SİGORTA KUTUSU H.FREE (ALEV YAYAN) (S/Ü) 36 Lİ	1 ad.	5	124,72
001 057 020006 00 00	COMFORT SİGORTA KUTUSU H.FREE (ALEV YAYAN) (S/A) 6 Lİ	1 ad.	20	40,49
001 057 020009 00 00	COMFORT SİGORTA KUTUSU H.FREE (ALEV YAYAN) (S/A) 9 LU	1 ad.	20	52,95
001 057 020012 00 00	COMFORT SİGORTA KUTUSU H.FREE (ALEV YAYAN) (S/A) 12 Lİ	1 ad.	10	66,54
001 057 020018 00 00	COMFORT SİGORTA KUTUSU H.FREE (ALEV YAYAN) (S/A) 18 Lİ	1 ad.	10	104,14
001 057 020024 00 00	COMFORT SİGORTA KUTUSU H.FREE (ALEV YAYAN) (S/A) 24 LÜ	1 ad.	5	106,99
001 057 020036 00 00	COMFORT SİGORTA KUTUSU H.FREE (ALEV YAYAN) (S/A) 36 Lİ	1 ad.	5	121,47

COMFORT W OTOMAT ZAYIF AKIM KUTULARI

IP40

001 057 101012 00 00	COMFORT ZAYIF AKIM KUTUSU (S/Ü)(225x270)	1 ad.	10	54,53
001 057 101020 00 00	COMFORT ZAYIF AKIM KUTUSU (S/Ü)(270x340)	1 ad.	5	89,68
001 057 101024 00 00	COMFORT 12 Lİ SİGORTA + ZAYIF AKIM KUTUSU (S/Ü)	1 ad.	5	91,78
001 057 101036 00 00	COMFORT 24 LÜ SİGORTA + ZAYIF AKIM KUTUSU (S/Ü)	1 ad.	5	123,41
001 057 001012 00 00	COMFORT ZAYIF AKIM KUTUSU (S/A)(205x250)	1 ad.	10	52,17
001 057 001020 00 00	COMFORT ZAYIF AKIM KUTUSU (S/A)(243x318)	1 ad.	5	139,50
001 057 001024 00 00	COMFORT 12 Lİ SİGORTA + ZAYIF AKIM KUTUSU (S/A)	1 ad.	5	88,75
001 057 001036 00 00	COMFORT 24 LÜ SİGORTA + ZAYIF AKIM KUTUSU (S/A)	1 ad.	5	120,61

COMFORT W OTOMAT ZAYIF AKIM KUTULARI H.FREE (ALEV YAYAN)

IP40

HF

001 057 121012 00 00	COMFORT ZAYIF AKIM KUTUSU H.FREE (ALEV YAYAN) (S/Ü)(225x270)	1 ad.	10	69,04
001 057 121020 00 00	COMFORT ZAYIF AKIM KUTUSU H.FREE (ALEV YAYAN) (S/Ü)(270x340)	1 ad.	5	94,70
001 057 121024 00 00	COMFORT 12 Lİ SİGORTA + ZAYIF AKIM KUTUSU H.FREE (ALEV YAYAN) (S/Ü)	1 ad.	5	97,42
001 057 121036 00 00	COMFORT 24 LÜ SİGORTA + ZAYIF AKIM KUTUSU H.FREE (ALEV YAYAN) (S/Ü)	1 ad.	5	128,07
001 057 021012 00 00	COMFORT ZAYIF AKIM KUTUSU H.FREE (ALEV YAYAN) (S/A)(205x250)	1 ad.	10	54,29
001 057 021020 00 00	COMFORT ZAYIF AKIM KUTUSU H.FREE (ALEV YAYAN) (S/A)(243x318)	1 ad.	5	100,55
001 057 021024 00 00	COMFORT 12 Lİ SİGORTA + ZAYIF AKIM KUTUSU H.FREE (ALEV YAYAN) (S/A)	1 ad.	5	94,38
001 057 021036 00 00	COMFORT 24 LÜ SİGORTA + ZAYIF AKIM KUTUSU H.FREE (ALEV YAYAN) (S/A)	1 ad.	5	123,79

COMFORT W OTOMAT ZAYIF AKIM KUTULARI (ALEV YAYMAYAN)

IP40

001 057 111012 00 00	COMFORT ZAYIF AKIM KUTUSU(A.YAYMAYAN)(S/Ü)(225x270)	1 ad.	10	76,13
001 057 111020 00 00	COMFORT ZAYIF AKIM KUTUSU(A.YAYMAYAN)(S/Ü)(270x340)	1 ad.	5	113,64
001 057 111024 00 00	COMFORT 12 Lİ SİGORTA + ZAYIF AKIM KUTUSU(A.YAYMAYAN)(S/Ü)	1 ad.	5	115,91
001 057 111036 00 00	COMFORT 24 LÜ SİGORTA + ZAYIF AKIM KUTUSU(A.YAYMAYAN)(S/Ü)	1 ad.	5	155,03
001 057 011012 00 00	COMFORT ZAYIF AKIM KUTUSU(A.YAYMAYAN)(S/A)(205x250)	1 ad.	10	73,27
001 057 011020 00 00	COMFORT ZAYIF AKIM KUTUSU(A.YAYMAYAN)(S/A)(243x318)	1 ad.	5	116,46
001 057 011024 00 00	COMFORT 12 Lİ SİGORTA + ZAYIF AKIM KUTUSU(A.YAYMAYAN)(S/A)	1 ad.	5	111,91
001 057 011036 00 00	COMFORT 24 LÜ SİGORTA + ZAYIF AKIM KUTUSU(A.YAYMAYAN)(S/A)	1 ad.	5	152,93

COMFORT W OTOMAT KUTUSU AKSESUARLARI

IP40

001 057 990001 00 00	S/A COMFORT ALÇIPAN MONTAJ SETİ	1 ad.		4,69
001 057 990002 00 00	COMFORT SU TERAZİSİ	1 ad.		5,98
000 700 000574 00 00	RAY YÜKSELTME PARÇASI (UZUN/KISA)	1 ad.		0,91
001 057 001236 00 00	COMFORT ZAYIF AKIM ÖRTME PARÇASI	50 ad.		5,20

Kod	Açıklama / Stok Cinsi	Amb. (Kutu)	Amb. Birimi	FIYAT
COMFORT W OTOMAT ZAYIF AKIM KUTULARI (METAL) IP20				
001 058 000012 00 00	12'Lİ SIVA ALTI METAL TABANLI + PLASTİK KAPAKLI OTOMATİK SİGORTA KUTUSU			FIYAT SORUNUZ
001 058 001012 00 00	SIVA ALTI METAL TABANLI + PLASTİK KAPAKLI ZAYIF AKIM KUTUSU (12'Lİ OTOMATİK SİGORTA KUTUSU ÖLÇÜSÜNDE)			
001 058 000024 00 00	24'LÜ SIVA ALTI METAL TABANLI + PLASTİK KAPAKLI OTOMATİK SİGORTA KUTUSU			
001 058 001024 00 00	12 SİGORTALI + ZAYIF AKIM BÖLMELİ SIVA ALTI METAL TABANLI + PLASTİK KAPAKLI KUTU (24'LÜ OTOMATİK SİGORTA KUTUSU ÖLÇÜSÜNDE)			
001 058 000036 00 00	36'Lİ SIVA ALTI METAL TABANLI + PLASTİK KAPAKLI OTOMATİK SİGORTA KUTUSU			
001 058 001036 00 00	24 SİGORTALI + ZAYIF AKIM BÖLMELİ SIVA ALTI METAL TABANLI + PLASTİK KAPAKLI KUTU (36'Lİ OTOMATİK SİGORTA KUTUSU ÖLÇÜSÜNDE)			
001 058 602532 00 00	250 MM X 320 MM METAL SIVA ALTI ZAYIF AKIM KUTUSU (24'LÜ OTOMATİK SİGORTA KUTUSU ÖLÇÜSÜNDE)			
001 058 502532 00 00	250 MM X 320 MM SIVA ALTI METAL TABAN + PLASTİK KAPAKLI ZAYIF AKIM KUTUSU (24'LÜ OTOMATİK SİGORTA KUTUSU ÖLÇÜSÜNDE)			
001 058 602544 00 00	250 MM X 440 MM METAL SIVA ALTI ZAYIF AKIM KUTUSU			
001 058 604040 00 00	400 MM X 400 MM SIVA ALTI METAL ZAYIF AKIM KUTUSU			
001 058 400036 00 00	24 SİGORTALI + ZAYIF AKIM BÖLMELİ SIVA ALTI METAL KUTU			
001 058 400048 00 00	36 SİGORTALI + ZAYIF AKIM BÖLMELİ SIVA ALTI METAL KUTU			



ÖRTME PARÇALARI

001 026 000002 00 00	W OTOMAT ÖRTME PARÇASI (12'Lİ) YENİ TİP	50 ad.	400	3,82
----------------------	---	--------	-----	------

MEKSBOX W OTOMAT KUTULARI

IP30

001 027 200001 00 00	MÜHÜRLÜ W OTOMAT KUTUSU (S/Ü) 1 Lİ	20 ad.	160	4,19
001 027 200002 00 00	MÜHÜRLÜ W OTOMAT KUTUSU (S/Ü) 2 Lİ	20 ad.	80	5,08
001 027 200004 00 00	MÜHÜRLÜ W OTOMAT KUTUSU (S/Ü) 4 LÜ	10 ad.	80	6,61
001 027 100002 00 00	W OTOMAT KUTUSU (S/Ü) MEKSBOX 2 Lİ	1 ad.	30	27,55
001 027 000002 00 00	W OTOMAT KUTUSU (S/A) MEKSBOX 2 Lİ	1 ad.	30	28,14
001 027 100004 00 00	W OTOMAT KUTUSU (S/Ü) MEKSBOX 4 LÜ	1 ad.	20	29,33
001 027 000004 00 00	W OTOMAT KUTUSU (S/A) MEKSBOX 4 LÜ	1 ad.	20	27,35
001 027 100006 00 00	W OTOMAT KUTUSU (S/Ü) MEKSBOX 6 Lİ	1 ad.	20	35,27
001 027 000006 00 00	W OTOMAT KUTUSU (S/A) MEKSBOX 6 Lİ	1 ad.	20	33,43
001 027 100009 00 00	W OTOMAT KUTUSU (S/Ü) MEKSBOX 9 LÜ	1 ad.	20	42,81
001 027 000009 00 00	W OTOMAT KUTUSU (S/A) MEKSBOX 9 LÜ	1 ad.	20	42,87
001 027 100012 00 00	W OTOMAT KUTUSU (S/Ü) MEKSBOX 12 Lİ	1 ad.	10	54,98
001 027 000012 00 00	W OTOMAT KUTUSU (S/A) MEKSBOX 12 Lİ	1 ad.	10	55,41
001 027 100016 00 00	W OTOMAT KUTUSU (S/Ü) MEKSBOX 16 Lİ	1 ad.	10	66,43
001 027 000016 00 00	W OTOMAT KUTUSU (S/A) MEKSBOX 16 Lİ	1 ad.	10	62,40
001 027 100024 00 00	W OTOMAT KUTUSU (S/Ü) MEKSBOX 24 LÜ	1 ad.	5	94,96
001 027 000024 00 00	W OTOMAT KUTUSU (S/A) MEKSBOX 24 LÜ	1 ad.	5	89,09
001 027 100036 00 00	W OTOMAT KUTUSU (S/Ü) MEKSBOX 36 Lİ	1 ad.	5	125,21
001 027 000036 00 00	W OTOMAT KUTUSU (S/A) MEKSBOX 36 Lİ	1 ad.	5	120,39



MEKSBOX W OTOMAT KUTULARI (ALEV YAYMAYAN)

IP30

001 027 210001 00 00	MÜH.W OTOMAT KUTUSU ALEV YAYMAYAN (S/Ü) 1 Lİ	20 ad.	160	7,02
001 027 210002 00 00	MÜH.W OTOMAT KUTUSU ALEV YAYMAYAN (S/Ü) 2 Lİ	20 ad.	80	8,73
001 027 210004 00 00	MÜH.W OTOMAT KUTUSU ALEV YAYMAYAN (S/Ü) 4 LÜ	10 ad.	80	11,09
001 027 110002 00 00	W OTOMAT KUTUSU (S/Ü) ALEV YAYMAYAN 2 Lİ	1 ad.	30	32,96
001 027 010002 00 00	W OTOMAT KUTUSU (S/A) ALEV YAYMAYAN 2 Lİ	1 ad.	30	36,96
001 027 110004 00 00	W OTOMAT KUTUSU (S/Ü) ALEV YAYMAYAN 4 LÜ	1 ad.	20	41,04
001 027 010004 00 00	W OTOMAT KUTUSU (S/A) ALEV YAYMAYAN 4 LÜ	1 ad.	20	40,51
001 027 110006 00 00	W OTOMAT KUTUSU (S/Ü) ALEV YAYMAYAN 6 Lİ	1 ad.	20	50,38
001 027 010006 00 00	W OTOMAT KUTUSU (S/A) ALEV YAYMAYAN 6 Lİ	1 ad.	20	41,57
001 027 110009 00 00	W OTOMAT KUTUSU (S/Ü) ALEV YAYMAYAN 9 LÜ	1 ad.	20	63,59
001 027 010009 00 00	W OTOMAT KUTUSU (S/A) ALEV YAYMAYAN 9 LÜ	1 ad.	20	61,92
001 027 110012 00 00	W OTOMAT KUTUSU (S/Ü) ALEV YAYMAYAN 12 Lİ	1 ad.	10	79,23
001 027 010012 00 00	W OTOMAT KUTUSU (S/A) ALEV YAYMAYAN 12 Lİ	1 ad.	10	68,05
001 027 110016 00 00	W OTOMAT KUTUSU (S/Ü) ALEV YAYMAYAN 16 Lİ	1 ad.	10	93,71
001 027 010016 00 00	W OTOMAT KUTUSU (S/A) ALEV YAYMAYAN 16 Lİ	1 ad.	10	74,67
001 027 110024 00 00	W OTOMAT KUTUSU (S/Ü) ALEV YAYMAYAN 24 LÜ	1 ad.	5	139,85
001 027 010024 00 00	W OTOMAT KUTUSU (S/A) ALEV YAYMAYAN 24 LÜ	1 ad.	5	135,05
001 027 110036 00 00	W OTOMAT KUTUSU (S/Ü) ALEV YAYMAYAN 36 Lİ	1 ad.	5	193,62
001 027 010036 00 00	W OTOMAT KUTUSU (S/A) ALEV YAYMAYAN 36 Lİ	1 ad.	5	185,40



DAHA İYİ BİR SONUÇ İÇİN KANAL AKSESUARINI ALMAYI UNUTMAYIN

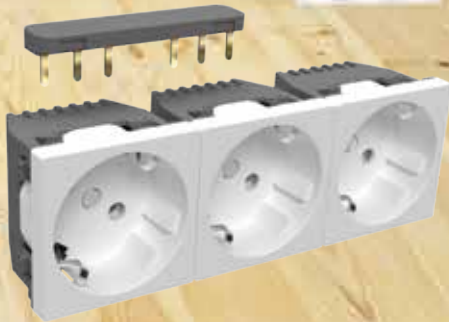

YENİ TIRNAK YAPISI İLE DAHA SAĞLAM DAHA GÜVENLİ

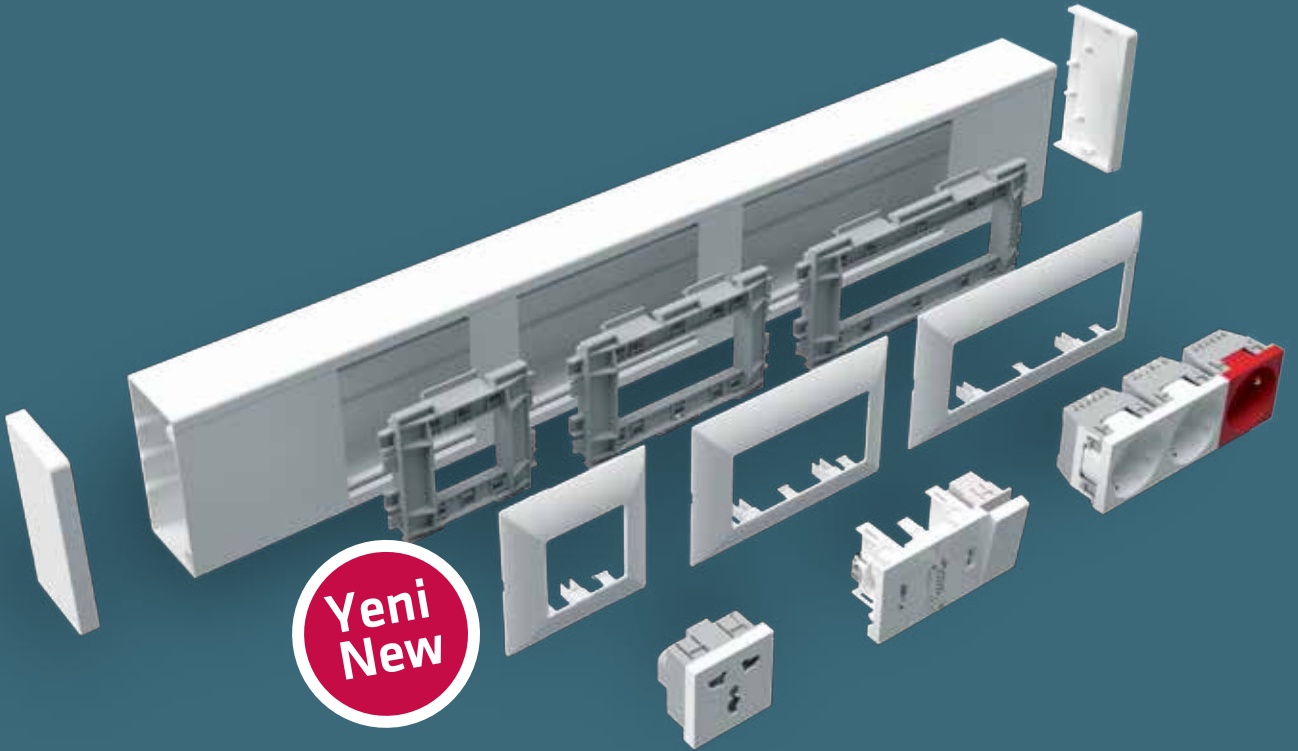

YENİ
LED
İÇİN ÖZEL
13x12,5mm

Kod	Açıklama / Stok Cinsi	Amb. (Kutu)	Amb. Birimi	FİYAT
LED İÇİN KENDİNDEN KAPAKLI KABLO KANALI				
001 004 013012 20 44	13X12,5 MM KABLO KANALI ŞEFFAF KANAL (LED İÇİN)	300	mt.	4,53
CANALEX SERİSİ TSE'Lİ KAPALI TİP KABLO KANALLARI (KUTULU)				
001 156 012012 20 00	12X12 MM KABLO KANALI (CANALEX)	250	mt.	1,31
001 156 015010 20 00	15X10 MM KABLO KANALI (CANALEX)	250	mt.	1,38
001 156 016016 20 00	16X16 MM KABLO KANALI (CANALEX)	250	mt.	1,69
001 156 020010 20 00	20X10 MM KABLO KANALI (CANALEX)	200	mt.	1,46
001 156 020015 20 00	20X15 MM KABLO KANALI (CANALEX)	200	mt.	2,51
001 156 025016 20 00	25X16 MM KABLO KANALI (CANALEX)	150	mt.	2,53
001 156 025025 20 00	25X25 MM KABLO KANALI (CANALEX)	100	mt.	3,35
001 156 040016 20 00	40X16 MM KABLO KANALI (CANALEX)	100	mt.	3,81
001 156 040025 20 00	40X25 MM KABLO KANALI (CANALEX)	80	mt.	4,35
001 156 040040 20 00	40X40 MM KABLO KANALI (CANALEX)	50	mt.	5,58
001 156 060040 20 00	60X40 MM KABLO KANALI (CANALEX)	40	mt.	8,86
001 156 060060 20 00	60X60 MM KABLO KANALI (CANALEX)	32	mt.	13,32
001 156 080040 20 00	80X40 MM KABLO KANALI (CANALEX)	30	mt.	12,82
001 156 080060 20 00	80X60 MM KABLO KANALI (CANALEX)	24	mt.	14,80
001 156 100040 20 00	100X40 MM KABLO KANALI (CANALEX)	24	mt.	15,61
001 156 100060 20 00	100X60 MM KABLO KANALI (CANALEX)	20	mt.	20,29
CANALEX SERİSİ TSE'Lİ KAPALI TİP KABLO KANALLARI (YAPIŞKAN BANTLI)				
001 157 012012 20 00	12X12 MM KABLO KANALI CANALEX (YAPIŞKAN BANTLI)	250	mt.	1,52
001 157 015010 20 00	15X10 MM KABLO KANALI CANALEX (YAPIŞKAN BANTLI)	230	mt.	1,76
001 157 016016 20 00	16X16 MM KABLO KANALI CANALEX (YAPIŞKAN BANTLI)	240	mt.	2,09
001 157 020010 20 00	20X10 MM KABLO KANALI CANALEX (YAPIŞKAN BANTLI)	200	mt.	1,83
001 157 020015 20 00	20X15 MM KABLO KANALI CANALEX (YAPIŞKAN BANTLI)	180	mt.	3,25
001 157 025016 20 00	25X16 MM KABLO KANALI CANALEX (YAPIŞKAN BANTLI)	150	mt.	3,52
001 157 025025 20 00	25X25 MM KABLO KANALI CANALEX (YAPIŞKAN BANTLI)	100	mt.	4,27
001 157 040016 20 00	40X16 MM KABLO KANALI CANALEX (YAPIŞKAN BANTLI)	100	mt.	5,05
001 157 040025 20 00	40X25 MM KABLO KANALI CANALEX (YAPIŞKAN BANTLI)	80	mt.	6,04
001 157 040040 20 00	40X40 MM KABLO KANALI CANALEX (YAPIŞKAN BANTLI)	50	mt.	7,62
001 157 060040 20 00	60X40 MM KABLO KANALI CANALEX (YAPIŞKAN BANTLI)	40	mt.	10,12
EKO SERİSİ TSE'Lİ KAPALI TİP KABLO KANALLARI				
001 014 010008 20 00	10X08 MM KABLO KANALI EKO	330	mt.	1,41
001 014 012012 20 00	12X12 MM KABLO KANALI EKO	250	mt.	1,50
001 014 015010 20 00	15X10 MM KABLO KANALI EKO	250	mt.	1,52
001 014 015015 20 00	15X15 MM KABLO KANALI EKO	250	mt.	2,22
001 014 016016 20 00	16X16 MM KABLO KANALI EKO	250	mt.	2,24
001 014 020010 20 00	20X10 MM KABLO KANALI EKO	200	mt.	1,89
001 014 025016 20 00	25X16 MM KABLO KANALI EKO	150	mt.	2,96
001 014 025025 20 00	25X25 MM KABLO KANALI EKO	100	mt.	3,89
001 014 025040 20 00	25X40 MM KABLO KANALI EKO	80	mt.	7,54
001 014 930010 20 00	30X10 MM KABLO KANALI EKO (BÖLMELİ)	140	mt.	3,77
001 014 930015 20 00	30X15 MM KABLO KANALI EKO	140	mt.	3,57
001 014 930016 20 00	30X16 MM KABLO KANALI EKO (BÖLMELİ)	140	mt.	4,83
001 014 930016 20 00	30X16 MM KABLO KANALI EKO	140	mt.	4,03
001 014 930025 20 00	30X25 MM KABLO KANALI EKO	80	mt.	5,14
001 014 930030 20 00	30X30 MM KABLO KANALI EKO	80	mt.	5,21
001 014 940016 20 00	40X16 MM KABLO KANALI EKO (BÖLMELİ)	100	mt.	5,67
001 014 940016 20 00	40X16 MM KABLO KANALI EKO	100	mt.	4,37
001 014 940025 20 00	40X25 MM KABLO KANALI EKO	80	mt.	5,85
001 014 940040 20 00	40X40 MM KABLO KANALI EKO	50	mt.	6,51
001 014 940060 20 00	40X60 MM KABLO KANALI EKO	40	mt.	14,51
001 014 960025 20 00	60X25 MM KABLO KANALI EKO (BÖLMELİ)	40	mt.	9,90
001 014 960040 20 00	60X40 MM KABLO KANALI EKO	40	mt.	9,81
001 014 050050 20 00	50X50 MM KABLO KANALI EKO	30	mt.	12,43
001 014 060060 20 00	60X60 MM KABLO KANALI EKO	32	mt.	13,94
001 014 075075 20 00	75X75 MM KABLO KANALI EKO	28	mt.	20,86
001 014 080040 20 00	80X40 MM KABLO KANALI EKO	30	mt.	15,78
001 014 080060 20 00	80X60 MM KABLO KANALI EKO	24	mt.	17,32
001 014 100040 20 00	100X40 MM KABLO KANALI EKO (PRİZ SETİ TAKILABİLİR)	24	mt.	17,83
001 014 100037 20 00	100X37 MM KABLO KANALI İÇTEN KAPAKLI KANAL EKO FOLYOLU (PRİZ SETİ TAKILABİLİR)	30	mt.	20,56
001 014 100050 20 00	100X50 MM KABLO KANALI İÇTEN KAPAKLI KANAL EKO FOLYOLU (PRİZ SETİ TAKILABİLİR)	20	mt.	20,90
001 014 100060 20 00	100X60 MM KABLO KANALI EKO (PRİZ SETİ TAKILABİLİR)	20	mt.	21,70
001 014 120060 20 00	120X60 MM KABLO KANALI EKO	16	mt.	33,61
001 014 100100 20 00	100X100 MM KABLO KANALI EKO	20	mt.	40,58
EKO SERİSİ KAPALI TİP KABLO KANALLARI (YAPIŞKAN BANTLI)				
001 004 009005 20 00	9X5 MM KABLO KANALI KEN.KAPAKLI	500	mt.	1,92
001 004 010007 20 44	9,5X7 MM KABLO KANALI ŞEFFAF KANAL	500	mt.	2,69
001 004 012007 20 00	12X7,5 MM KABLO KANALI KENDİNDEN KAPAKLI	350	mt.	2,16
001 004 013012 20 00	13X12,5 MM KABLO KANALI KENDİNDEN KAPAKLI	300	mt.	2,83
001 004 010008 20 00	10X8 MM KABLO KANALI EKO (YAPIŞKAN BANTLI)	330	mt.	1,70
001 004 010010 20 00	10X10 MM KABLO KANALI EKO KENDİNDEN KAPAKLI (YAPIŞKAN BANTLI)	320	mt.	2,19
001 004 012012 20 00	12X12 MM KABLO KANALI EKO (YAPIŞKAN BANTLI)	250	mt.	1,83
001 004 015010 20 00	15X10 MM KABLO KANALI EKO (YAPIŞKAN BANTLI)	230	mt.	1,95
001 004 016016 20 00	16X16 MM KABLO KANALI EKO (YAPIŞKAN BANTLI)	240	mt.	2,64
001 004 020010 20 00	20X10 MM KABLO KANALI EKO (YAPIŞKAN BANTLI)	180	mt.	2,30
001 004 025016 20 00	25X16 MM KABLO KANALI EKO (YAPIŞKAN BANTLI)	150	mt.	3,66
001 004 025025 20 00	25X25 MM KABLO KANALI EKO (YAPIŞKAN BANTLI)	100	mt.	4,48
001 004 025040 20 00	25X40 MM KABLO KANALI EKO (YAPIŞKAN BANTLI)	80	mt.	7,80
001 004 930010 20 00	30X10 MM KABLO KANALI EKO (YAPIŞKAN BANTLI) (BÖLMELİ)	140	mt.	4,17
001 004 930016 20 00	30X16 MM KABLO KANALI EKO (YAPIŞKAN BANTLI)	140	mt.	4,70
001 004 930025 20 00	30X25 MM KABLO KANALI EKO (YAPIŞKAN BANTLI)	80	mt.	5,49
001 004 940016 20 00	40X16 MM KABLO KANALI EKO (YAPIŞKAN BANTLI)	100	mt.	5,58
001 004 940025 20 00	40X25 MM KABLO KANALI EKO (YAPIŞKAN BANTLI)	80	mt.	7,29
001 004 940040 20 00	40X40 MM KABLO KANALI EKO (YAPIŞKAN BANTLI)	50	mt.	7,89
001 004 960040 20 00	60X40 MM KABLO KANALI EKO (YAPIŞKAN BANTLI)	40	mt.	11,84

Kod	Açıklama / Stok Cinsi	Amb. (Kutu)	Amb. Birimi	FIYAT
MEKS SERİSİ TSE'Lİ KAPALI TİP KABLO KANALLARI				
001 002 015015 20 00	15X15 MM KABLO KANALI MEKS	250	mt.	2,60
001 002 016016 20 00	16X16 MM KABLO KANALI MEKS	250	mt.	2,81
001 002 025016 20 00	25X16 MM KABLO KANALI MEKS	150	mt.	3,76
001 002 025025 20 00	25X25 MM KABLO KANALI MEKS	100	mt.	4,99
001 002 030015 20 00	30X15 MM KABLO KANALI MEKS	140	mt.	4,94
001 002 030030 20 00	30X30 MM KABLO KANALI MEKS	80	mt.	6,58
001 002 040017 20 00	40X17 MM KABLO KANALI TAM KAPAKLI MEKS	100	mt.	6,88
001 002 940017 20 00	40X17 MM KABLO KANALI TAM KAPAKLI MEKS (BÖLMELİ)	100	mt.	5,29
001 002 040025 20 00	40X25 MM KABLO KANALI MEKS	80	mt.	6,94
001 002 040040 20 00	40X40 MM KABLO KANALI MEKS	50	mt.	8,04
001 002 960025 20 00	60X25 MM KABLO KANALI MEKS (BÖLMELİ)	40	mt.	11,07
001 002 060040 20 00	60X40 MM KABLO KANALI MEKS	40	mt.	10,71
001 002 080060 20 00	80X60 MM KABLO KANALI MEKS	24	mt.	18,25
001 002 100036 20 00	100X36 MM KABLO KANALI MEKS	30	mt.	25,59
001 002 100040 20 00	100X40 MM KABLO KANALI MEKS (PRİZ SETİ TAKILABİLİR)	24	mt.	23,14
001 002 100048 20 00	100X48 MM KABLO KANALI MEKS (PRİZ SETİ TAKILABİLİR)	24	mt.	29,38
001 002 120070 20 00	120X70 MM KABLO KANALI (İÇTEN KAPAKLI)(AKSESUARLARI)	16	mt.	39,90
001 002 170070 20 00	170X70 MM KABLO KANALI (İÇTEN KAPAKLI)(AKSESUARLARI)	12	mt.	53,06
001 002 250070 20 00	250X70 MM KABLO KANALI (İÇTEN KAPAKLI)(AKSESUARLARI)	8	mt.	81,59
001 002 100060 20 00	100X60 MM KABLO KANALI MEKS (PRİZ SETİ TAKILABİLİR)	20	mt.	28,75
001 002 120060 20 00	120X60 MM KABLO KANALI MEKS	16	mt.	35,01

MEKS SERİSİ KAPALI TİP KABLO KANALLARI

001 002 100037 20 00	100X37 MM KABLO KANALI MEKS (İÇTEN KAPAKLI)(FOLYOLU)	30	mt.	25,34
001 002 100041 20 00	100X41 MM KABLO KANALI MEKS (İÇTEN KAPAKLI)(FOLYOLU)	24	mt.	23,04
001 002 100050 20 00	100X50 MM KABLO KANALI MEKS (İÇTEN KAPAKLI)(FOLYOLU)	20	mt.	29,14

MEKSPUS SERİSİ KAPALI TİP KABLO KANALLARI

001 003 040025 20 00	40X25 MM KABLO KANALI (İÇTEN KAPAKLI)	80	mt.	9,18
001 003 100037 20 00	100X37 MM KABLO KANALI (İÇTEN KAPAKLI)	30	mt.	24,28
001 003 100041 20 00	100X41 MM KABLO KANALI (İÇTEN KAPAKLI)	24	mt.	24,79
001 003 100050 20 00	100X50 MM KABLO KANALI (İ. KAP.)(ET KALINLIĞI 2MM)	20	mt.	31,80
001 006 100050 20 00	100X50 MM KABLO KANALI (İÇTEN KAPAKLI)(KAİDESİZ SERİ)	20	mt.	36,72
001 003 120070 20 00	120X70 MM KABLO KANALI (İÇTEN KAPAKLI)(AKSESUARLARI)	16	mt.	39,26
001 003 170050 20 00	170X50 MM KABLO KANALI (İÇTEN KAPAKLI)	12	mt.	54,94
001 003 170070 20 00	170X70 MM KABLO KANALI (İÇTEN KAPAKLI)(AKSESUARLARI)	8	mt.	62,64
001 003 250070 20 00	250X70 MM KABLO KANALI (İÇTEN KAPAKLI)(AKSESUARLARI)	8	mt.	91,76

MEKS SERİSİ KLİMA KANALI VE AKSESUARLARI

001 002 075060 20 00	75X60 MM KLİMA KANALI	30	mt.	16,05
001 050 030002 00 00	KLİMA KANALI KABLO TUTUCUSU	60	ad.	1,95
001 043 075060 00 00	KLİMA KANALI EK PARÇASI	40	ad.	1,89
001 039 075060 00 00	KLİMA KANALI İÇ KOŞE	24	ad.	3,52
001 040 075060 00 00	KLİMA KANALI DIŞ KOŞE	24	ad.	3,60
001 042 075060 00 00	KLİMA KANALI L KOŞE	18	ad.	3,33
001 050 030001 00 00	KLİMA KANALI DUVAR GEÇİŞİ	60	ad.	3,34
001 044 075060 01 00	KLİMA KANALI İÇ SONLAMA	30	ad.	3,54
001 044 075060 02 00	KLİMA KANALI DIŞ SONLAMA	18	ad.	3,29

TAVAN KÖŞE KANALI (23X23) VE AKSESUARLARI

001 002 023023 20 00	23X23 MM TAVAN KÖŞE KANALI	120	mt.	5,70
001 041 023023 00 00	23X23 MM T PARÇASI	60	ad.	2,12
001 042 023023 00 00	23X23 MM 90 L KOŞE	60	ad.	1,73
001 043 023023 00 00	23X23 MM EK PARÇA	100	ad.	0,55
001 044 023023 00 00	23X23 MM UÇ TAPA	100	ad.	0,40

SÜPÜRGELİK KABLO KANALLARI VE AKSESUARLARI

001 010 000200 20 00	50'LİK FUGALI SÜPÜRGELİK	60	mt.	5,99
001 014 974020 20 00	74X20 MM KABLO KANALI EKO (BÖLMELİ)	50	mt.	12,11
001 002 975022 20 00	75X22 MM KABLO KANALI MEKS (BÖLMELİ)	50	mt.	17,78
001 039 074020 00 00	74X20 İÇ KOŞE	20	ad.	1,76
001 040 074020 00 00	74X20 DIŞ KOŞE	20	ad.	2,79
001 041 074020 00 00	74X20 T KOŞE	30	ad.	3,65
001 042 074020 01 00	74X20 90 L KOŞE	40	ad.	3,65
001 043 074020 00 00	74X20 EK PARÇA	50	ad.	1,19
001 044 074020 00 00	74X20 UÇ TAPA	50	ad.	1,41
001 047 017420 00 00	74X20 PRİZ MONTAJ KASASI	6	ad.	13,20
001 047 017421 00 00	74X20 1' Lİ PRİZ MONTAJ KASASI	12	ad.	22,50
001 002 975022 20 00	75X22 MM KABLO KANALI (BÖLMELİ)	50	mt.	17,78
001 039 075022 00 00	75X22 MM İÇ KOŞE	20	ad.	2,57
001 040 075022 00 00	75X22 MM DIŞ KOŞE	20	ad.	2,32
001 044 075022 01 00	75X22 MM SAĞ SONLAMA	30	ad.	2,10
001 044 075022 02 00	75X22 MM SOL SONLAMA	20	ad.	2,10
001 043 075022 00 00	75X22 MM EK PARÇASI	100	ad.	1,56

TEZGAH SÜPÜRGELİĞİ



















001 011 000100 00 00	25'LİK TEZGAH SÜPÜRGELİĞİ 100CM	60	mt.	7,59
----------------------	---------------------------------	----	-----	------

BALIK SIRTİ ZEMİN KANALLARI



















001 002 050013 20 17	50X13 MM BALIK SIRTİ KANAL (ZEMİN İÇİN)	60	mt.	7,78
001 002 060015 20 17	60X15 MM BALIK SIRTİ KANAL (ZEMİN İÇİN)	40	mt.	9,66
001 002 075018 20 17	75X18 MM BALIK SIRTİ KANAL (ZEMİN İÇİN)	30	mt.	15,81
001 002 090020 20 17	90X20 MM BALIK SIRTİ KANAL (ZEMİN İÇİN)	20	mt.	20,77
001 004 050013 20 17	50X13 MM KABLO KANALI BALIK SIRTİ (YAPIŞKAN BANTLI)	60	mt.	9,51
001 004 060015 20 17	60X15 MM KABLO KANALI BALIK SIRTİ (YAPIŞKAN BANTLI)	40	mt.	10,33
001 004 075018 20 17	75X18 MM KABLO KANALI BALIK SIRTİ (YAPIŞKAN BANTLI)	30	mt.	17,25
001 004 090020 20 17	90X20 MM KABLO KANALI BALIK SIRTİ (YAPIŞKAN BANTLI)	20	mt.	20,47





Kod	Açıklama / Stok Cinsi	Amb. (Kutu)	Amb. Birimi	FİYAT
H.FREE FLARET SERİSİ KAPALI TİP KABLO KANALLARI   				
001 060 100050 20 00	100X50 MM KABLO KANALI İÇTEN KAPAKLI HALOJEN FREE	20	mt.	82,68
001 061 100050 20 00	100X50 MM KABLO KANALI ARA BÖLME HALOJEN FREE	150	mt.	9,44
001 039 100050 11 00	100X50-37 MM KABLO KANALI İÇ KÖŞE(HAREKETLİ) HALOJEN FREE	12	ad.	10,11
001 040 100050 11 00	100X50 MM KABLO KANALI DIŞ KÖŞE(HAREKETLİ) HALOJEN FREE	10	ad.	10,06
001 041 100050 11 00	100X50 MM KABLO KANALI T PARÇASI HALOJEN FREE	10	ad.	9,69
001 042 100050 11 00	100X50 MM KABLO KANALI 90 L KÖŞE HALOJEN FREE	10	ad.	9,66
001 043 100050 11 00	100X50 MM KABLO KANALI EK PARÇA(UÇLU SET) HALOJEN FREE	100	ad.	2,88
001 044 100050 11 00	100X50 MM KABLO KANALI UÇ TAPA HALOJEN FREE	40	ad.	3,36
001 047 100001 11 00	PMS(100X37/50)(45X45)(1LÜ) HALOJEN FREE	20	ad.	9,33
001 047 100002 11 00	PMS(100X37/50)(45X45)(2LÜ) HALOJEN FREE	14	ad.	11,91
001 047 100003 11 00	PMS(100X37/50)(45X45)(3LÜ) HALOJEN FREE	12	ad.	12,71
H.FREE FLARET SERİSİ KAPALI TİP KABLO KANALLARI   				
001 060 025016 20 00	25X16 MM KABLO KANALI HALOJEN FREE	150	mt.	14,62
001 060 025025 20 00	25X25 MM KABLO KANALI HALOJEN FREE	100	mt.	14,86
001 060 040025 20 00	40X25 MM KABLO KANALI HALOJEN FREE	80	mt.	21,86
001 060 040040 20 00	40X40 MM KABLO KANALI HALOJEN FREE	50	mt.	25,74
25X16 H.FREE FLARET KANAL AKSESUARLARI   				
001 039 025016 11 00	25X16 MM İÇ KÖŞE	40	ad.	1,21
001 040 025016 11 00	25X16 MM DIŞ KÖŞE	40	ad.	1,21
001 041 025016 11 00	25X16 MM T PARÇASI	30	ad.	1,59
001 042 025016 11 00	25X16 MM 90 L KÖŞE	50	ad.	1,59
001 043 025016 11 00	25X16 MM EK PARÇA	100	ad.	1,06
001 044 025016 11 00	25X16 MM UÇ TAPA	100	ad.	1,14
25X25 H.FREE FLARET KANAL AKSESUARLARI   				
001 039 025025 11 00	25X25 MM İÇ KÖŞE	40	ad.	1,33
001 040 025025 11 00	25X25 MM DIŞ KÖŞE	40	ad.	1,37
001 041 025025 11 00	25X25 MM T PARÇASI	30	ad.	2,08
001 042 025025 11 00	25X25 MM 90 L KÖŞE	50	ad.	2,08
001 043 025025 11 00	25X25 MM EK PARÇA	100	ad.	1,10
001 044 025025 11 00	25X25 MM UÇ TAPA	100	ad.	1,03
40X25 H.FREE FLARET KANAL AKSESUARLARI   				
001 039 040025 11 00	40X25 MM İÇ KÖŞE	24	ad.	2,13
001 040 040025 11 00	40X25 MM DIŞ KÖŞE	30	ad.	2,16
001 041 040025 11 00	40X25 MM T PARÇASI	18	ad.	3,16
001 042 040025 11 00	40X25 MM 90 L KÖŞE	24	ad.	2,49
001 043 040025 11 00	40X25 MM EK PARÇA	70	ad.	1,41
001 044 040025 11 00	40X25 MM UÇ TAPA	25	ad.	1,41
40X40 H.FREE FLARET KANAL AKSESUARLARI   				
001 039 040040 11 00	40X40 MM İÇ KÖŞE	18	ad.	5,39
001 040 040040 11 00	40X40 MM DIŞ KÖŞE	10	ad.	5,34
001 041 040040 11 00	40X40 MM T PARÇASI	48	ad.	3,66
001 042 040040 11 00	40X40 MM 90 L KÖŞE	60	ad.	3,00
001 043 040040 11 00	40X40 MM EK PARÇA	100	ad.	1,35
001 044 040040 11 00	40X40 MM UÇ TAPA	25	ad.	1,35



Kod	Açıklama / Stok Cinsi	Amb. (Kutu)	Amb. Birimi	FIYAT
BALIK SIRTI 60X15 AKSESUARLARI				
001 042 060015 00 17	60X15 MM BALIK SIRTI KANAL L KÖŞE	24	ad.	4,34
001 043 060015 00 17	60X15 MM BALIK SIRTI KANAL EK PARÇASI	50	ad.	1,53
001 044 060015 00 17	60X15 MM BALIK SIRTI KANAL SONLAMA KAPAĞI	50	ad.	1,50
001 041 060015 00 17	60X15 MM BALIK SIRTI KANAL T KÖŞE	10	ad.	4,62
BALIK SIRTI 75X18 AKSESUARLARI				
001 042 075018 00 17	75X18 MM BALIK SIRTI KANAL L KÖŞE	15	ad.	4,93
001 043 075018 00 17	75X18 MM BALIK SIRTI KANAL EK PARÇASI	50	ad.	2,06
001 044 075018 00 17	75X18 MM BALIK SIRTI KANAL SONLAMA KAPAĞI	50	ad.	2,09
001 041 075018 00 17	75X18 MM BALIK SIRTI KANAL T KÖŞE	8	ad.	4,99
BALIK SIRTI 90X20 AKSESUARLARI				
001 042 090020 00 17	90X20 MM BALIK SIRTI KANAL KANAL L KÖŞE	20	ad.	5,58
001 043 090020 00 17	90X20 MM BALIK SIRTI KANAL EK PARÇASI	50	ad.	2,16
001 044 090020 00 17	90X20 MM BALIK SIRTI KANAL SONLAMA KAPAĞI	50	ad.	2,87
001 041 090020 00 17	90X20 MM BALIK SIRTI KANAL T KÖŞE	12	ad.	5,87
12X12 KANAL AKSESUARLARI   IP40				
001 039 012012 00 00	12X12 MM İÇ KÖŞE	60	ad.	0,72
001 040 012012 00 00	12X12 MM DIŞ KÖŞE	60	ad.	0,72
001 041 012012 00 00	12X12 MM T KÖŞE	60	ad.	0,76
001 042 012012 00 00	12X12 MM 90 L KÖŞE	60	ad.	0,79
001 044 012012 00 00	12X12 MM UÇ TAPA	100	ad.	1,60
001 043 012012 00 00	12X12 MM EK PARÇASI	100	ad.	1,67
15X10 KANAL AKSESUARLARI   IP40				
001 039 015010 00 00	15X10 MM İÇ KÖŞE	60	ad.	0,65
001 040 015010 00 00	15X10 MM DIŞ KÖŞE	60	ad.	0,66
001 041 015010 00 00	15X10 MM T KÖŞE	60	ad.	0,84
001 042 015010 00 00	15X10 MM 90 L KÖŞE	60	ad.	0,84
001 044 015010 00 00	15X10 MM UÇ TAPA	100	ad.	1,60
001 043 016016 00 00	15X10 MM EK PARÇASI	100	ad.	0,89
20X10 KANAL AKSESUARLARI   IP40				
001 039 020010 00 00	20X10 MM İÇ KÖŞE	60	ad.	0,83
001 040 020010 00 00	20X10 MM DIŞ KÖŞE	60	ad.	0,83
001 041 020010 00 00	20X10 MM T KÖŞE	30	ad.	1,01
001 042 020010 00 00	20X10 MM 90 L KÖŞE	50	ad.	0,82
001 044 020010 00 00	20X10 MM UÇ TAPA	100	ad.	0,85
001 043 020010 00 00	20X10 MM EK PARÇASI	100	ad.	0,88
16X16 KANAL AKSESUARLARI   IP40				
001 039 016016 00 00	16X16 MM İÇ KÖŞE	100	ad.	0,83
001 040 016016 00 00	16X16 MM DIŞ KÖŞE	100	ad.	0,83
001 041 016016 00 00	16X16 MM T KÖŞE	60	ad.	1,07
001 042 016016 00 00	16X16 MM 90 L KÖŞE	60	ad.	0,97
001 044 016016 00 00	16X16 MM UÇ TAPA	100	ad.	0,80
001 043 016016 00 00	16X16 MM EK PARÇASI	100	ad.	0,89
25X16 KANAL AKSESUARLARI   IP40				
001 039 025016 00 00	25X16 MM İÇ KÖŞE	40	ad.	1,01
001 040 025016 00 00	25X16 MM DIŞ KÖŞE	40	ad.	1,01
001 041 025016 00 00	25X16 MM T KÖŞE	30	ad.	1,32
001 042 025016 00 00	25X16 MM 90 L KÖŞE	50	ad.	1,32
001 044 025016 00 00	25X16 MM UÇ TAPA	100	ad.	0,95
001 043 025016 00 00	25X16 MM EK PARÇA	100	ad.	0,89
001 047 017421 00 00	25X16 MM PMK (45X45)	12	ad.	22,50
25X25 KANAL AKSESUARLARI   IP40				
001 039 025025 00 00	25X25 MM İÇ KÖŞE	40	ad.	1,11
001 040 025025 00 00	25X25 MM DIŞ KÖŞE	40	ad.	1,14
001 041 025025 00 00	25X25 MM T PARÇASI	24	ad.	1,74
001 042 025025 00 00	25X25 MM 90 L KÖŞE	40	ad.	1,73
001 044 025025 00 00	25X25 MM UÇ TAPA	100	ad.	0,86
001 043 025025 00 00	25X25 MM EK PARÇA	50	ad.	0,92
001 047 017421 00 00	25X25 MM PMK (45X45)	12	ad.	22,50
30X10 KANAL AKSESUARLARI   IP40				
001 039 030010 00 00	30X10 MM İÇ KÖŞE	50	ad.	3,47
001 040 030010 00 00	30X10 MM DIŞ KÖŞE	50	ad.	3,48
001 041 030010 00 00	30X10 MM T PARÇASI	50	ad.	3,68
001 042 030010 00 00	30X10 MM 90 L KÖŞE	50	ad.	2,87
001 044 030010 00 00	30X10 MM UÇ TAPA	100	ad.	1,35
001 043 030010 00 00	30X10 MM EK PARÇA	100	ad.	1,35
30X16 KANAL AKSESUARLARI   IP40				
001 039 030016 00 00	30X16 MM İÇ KÖŞE	35	ad.	1,62
001 040 030016 00 00	30X16 MM DIŞ KÖŞE	48	ad.	1,63
001 041 030016 00 00	30X16 MM T PARÇASI	40	ad.	2,98
001 042 030016 00 00	30X16 MM 90 L KÖŞE	50	ad.	2,91
001 044 030016 00 00	30X16 MM UÇ TAPA	100	ad.	1,30
001 043 030016 00 00	30X16 MM EK PARÇA	100	ad.	1,33
30X25 KANAL AKSESUARLARI   IP40				
001 039 030025 00 00	30X25 MM İÇ KÖŞE	30	ad.	3,91
001 040 030025 00 00	30X25 MM DIŞ KÖŞE	32	ad.	3,92
001 041 030025 00 00	30X25 MM T PARÇASI	24	ad.	3,35
001 042 030025 00 00	30X25 MM 90 L KÖŞE	30	ad.	3,29
001 044 030025 00 00	30X25 MM UÇ TAPA	100	ad.	1,30
001 043 030025 00 00	30X25 MM EK PARÇA	100	ad.	1,33



EK PARÇA



T KÖŞE



İÇ KÖŞE



DIŞ KÖŞE











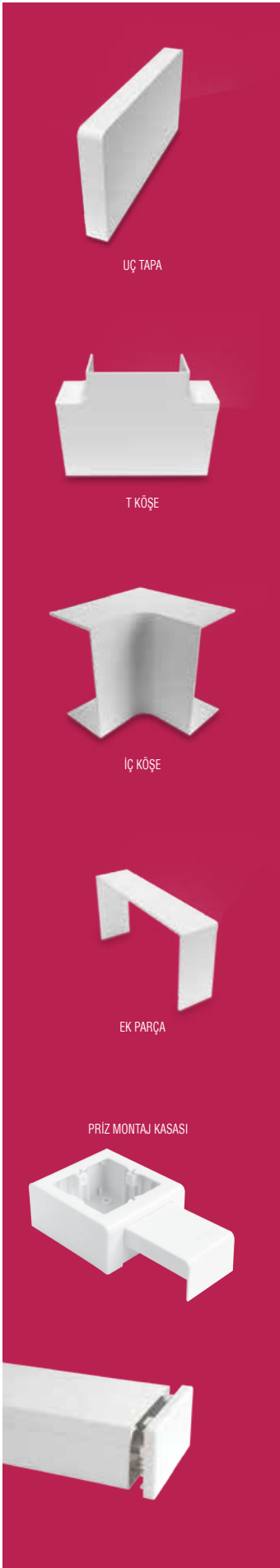













L KÖŞE











UÇ TAPA





Kod	Açıklama / Stok Cinsi	Amb. (Kutu)	Amb. Birimi	FİYAT
40X16 KANAL AKSESUARLARI   IP40				
001 039 040016 00 00	40X16 MM İÇ KÖŞE	32	ad.	3,62
001 040 040016 00 00	40X16 MM DİŞ KÖŞE	30	ad.	3,59
001 041 040016 00 00	40X16 MM T KÖŞE	24	ad.	2,18
001 042 040016 00 00	40X16 MM 90 L KÖŞE	34	ad.	2,15
001 044 040016 00 00	40X16 MM UÇ TAPA	25	ad.	1,82
001 043 040016 00 00	40X16 MM EK PARÇASI	100	ad.	0,99
001 047 017421 00 00	40X16 MM PMK (45X45)	12	ad.	22,50
40X25 KANAL AKSESUARLARI   IP40				
001 039 040025 00 00	40X25 MM İÇ KÖŞE	24	ad.	1,77
001 040 040025 00 00	40X25 MM DİŞ KÖŞE	30	ad.	1,80
001 041 040025 00 00	40X25 MM T KÖŞE	18	ad.	2,63
001 042 040025 00 00	40X25 MM 90 L KÖŞE	24	ad.	2,08
001 044 040025 00 00	40X25 MM UÇ TAPA	25	ad.	1,17
001 043 040016 00 00	40X25 MM EK PARÇASI	100	ad.	0,99
001 047 017421 00 00	40X25 MM PMK (45X45)	12	ad.	22,50
40X40 KANAL AKSESUARLARI   IP40				
001 039 040040 00 00	40X40 MM İÇ KÖŞE	18	ad.	4,49
001 040 040040 00 00	40X40 MM DİŞ KÖŞE	10	ad.	4,45
001 041 040040 00 00	40X40 MM T PARÇASI	48	ad.	3,05
001 042 040040 00 00	40X40 MM 90 L KÖŞE	60	ad.	2,50
001 044 040040 00 00	40X40 MM UÇ TAPA	25	ad.	1,12
001 043 040016 00 00	40X40 MM EK PARÇA	100	ad.	0,99
001 047 017421 00 00	40X40 MM PMK (45X45)	12	ad.	22,50
60X25 KANAL AKSESUARLARI   IP40				
001 039 060025 00 00	60X25 MM İÇ KÖŞE	48	ad.	3,41
001 040 060025 00 00	60X25 MM DİŞ KÖŞE	72	ad.	3,90
001 041 060025 00 00	60X25 MM T PARÇASI	40	ad.	3,61
001 042 060025 00 00	60X25 MM 90 L KÖŞE	60	ad.	3,06
001 044 060025 00 00	60X25 MM UÇ TAPA	50	ad.	4,24
001 043 060025 00 00	60X25 MM EK PARÇA	60	ad.	4,24
60X40 KANAL AKSESUARLARI   IP40				
001 039 060040 00 00	60X40 MM İÇ KÖŞE	26	ad.	4,77
001 040 060040 00 00	60X40 MM DİŞ KÖŞE	32	ad.	4,76
001 041 060040 00 00	60X40 MM T PARÇASI	32	ad.	2,94
001 042 060040 00 00	60X40 MM 90 L KÖŞE	40	ad.	3,10
001 044 060040 00 00	60X40 MM UÇ TAPA	50	ad.	3,61
001 043 060040 00 00	60X40 MM EK PARÇA	40	ad.	4,22
60X60 KANAL AKSESUARLARI   IP40				
001 039 060060 01 00	60X60 MM İÇ KÖŞE (HAREKETLİ)	16	ad.	7,06
001 040 060060 01 00	60X60 MM DİŞ KÖŞE (HAREKETLİ)	16	ad.	6,68
001 041 060060 00 00	60X60 MM T PARÇASI	20	ad.	6,24
001 042 060060 00 00	60X60 MM 90 L KÖŞE	24	ad.	5,92
001 044 060060 00 00	60X60 MM UÇ TAPA	30	ad.	2,31
001 043 060060 00 00	60X60 MM EK PARÇA	25	ad.	2,26
80X40 KANAL AKSESUARLARI   IP40				
001 039 080040 00 00	80X40 MM İÇ KÖŞE	18	ad.	7,20
001 040 080040 00 00	80X40 MM DİŞ KÖŞE	8	ad.	7,34
001 041 080040 00 00	80X40 MM T PARÇASI	12	ad.	8,14
001 042 080040 00 00	80X40 MM 90 L KÖŞE	16	ad.	7,26
001 044 080040 00 00	80X40 MM UÇ TAPA	60	ad.	1,33
001 043 080040 00 00	80X40 MM EK PARÇA	100	ad.	1,34
80X60 KANAL AKSESUARLARI   IP40				
001 039 080060 00 00	80X60 MM İÇ KÖŞE	12	ad.	9,08
001 040 080060 00 00	80X60 MM DİŞ KÖŞE	8	ad.	9,21
001 041 080060 00 00	80X60 MM T PARÇASI	10	ad.	9,83
001 042 080060 00 00	80X60 MM 90 L KÖŞE	12	ad.	9,84
001 044 080060 00 00	80X60 MM UÇ TAPA	48	ad.	3,11
001 043 080060 00 00	80X60 MM EK PARÇA	80	ad.	3,99
100X36 KANAL AKSESUARLARI   IP40				
001 039 100036 00 00	100X36 MM İÇ KÖŞE (SABİT)	8	ad.	8,78
001 040 100036 00 00	100X36 MM DİŞ KÖŞE (SABİT)	8	ad.	8,31
001 039 100040 01 00	100X36 MM İÇ KÖŞE (HAREKETLİ)	8	ad.	7,41
001 040 100040 01 00	100X36 MM DİŞ KÖŞE (HAREKETLİ)	10	ad.	8,52
001 041 100036 00 00	100X36 MM T PARÇASI	12	ad.	9,06
001 042 100036 00 00	100X36 MM 90 L KÖŞE	12	ad.	9,03
001 044 100036 00 00	100X36 MM UÇ TAPA	16	ad.	6,32
001 043 100036 00 00	100X36 MM EK PARÇA	100	ad.	6,28
001 050 030004 00 00	100X36 MM KANAL KİLİTLEME APARATI	100	ad.	0,98
001 013 100036 20 00	100X36 MM ARA BÖLME	200	mt.	4,75
100X37 KANAL AKSESUARLARI   IP40				
001 039 100037 00 00	100X37 MM İÇ KÖŞE (SABİT)	12	ad.	5,48
001 040 100037 00 00	100X37 MM DİŞ KÖŞE (SABİT)	8	ad.	5,56
001 039 100050 01 00	100X37 MM İÇ KÖŞE (HAREKETLİ)	12	ad.	6,15
001 040 100050 01 00	100X37 MM DİŞ KÖŞE (HAREKETLİ)	10	ad.	6,37
001 041 100037 00 00	100X37 MM T PARÇASI	14	ad.	5,85
001 042 100037 00 00	100X37 MM 90 L KÖŞE	14	ad.	6,92
001 044 100037 00 00	100X37 MM UÇ TAPA	50	ad.	2,39
001 043 100037 00 00	100X37 MM EK PARÇA	100	ad.	2,11
100X40 KANAL AKSESUARLARI   IP40				
001 039 100040 00 00	100X40 MM İÇ KÖŞE (SABİT)	8	ad.	7,44
001 040 100040 00 00	100X40 MM DİŞ KÖŞE (SABİT)	8	ad.	8,37
001 039 100040 01 00	100X40 MM İÇ KÖŞE (HAREKETLİ)	16	ad.	7,41
001 040 100040 01 00	100X40 MM DİŞ KÖŞE (HAREKETLİ)	10	ad.	8,52
001 041 100040 00 00	100X40 MM T PARÇASI	12	ad.	10,12
001 042 100040 00 00	100X40 MM 90 L KÖŞE	12	ad.	9,30
001 044 100040 00 00	100X40 MM UÇ TAPA	20	ad.	4,31
001 043 100040 00 00	100X40 MM EK PARÇA	100	ad.	4,20
001 050 030004 00 00	100X40 MM KANAL KİLİTLEME APARATI	100	ad.	0,98
001 013 100040 20 00	100X40 MM ARA BÖLME	200	mt.	4,90

Kod	Açıklama / Stok Cinsi	Amb. (Kutu)	Amb. Birimi	FIYAT
100X48 KANAL AKSESUARLARI  CE IP40				
001 039 100048 00 00	100X48 MM İÇ KÖŞE (SABİT)	8	ad.	8,81
001 040 100048 00 00	100X48 MM DIŞ KÖŞE (SABİT)	8	ad.	8,87
001 039 100060 01 00	100X48 MM İÇ KÖŞE (HAREKETLİ)	10	ad.	7,89
001 040 100060 01 00	100X48 MM DIŞ KÖŞE (HAREKETLİ)	10	ad.	8,86
001 041 100048 00 00	100X48 MM T PARÇASI	8	ad.	9,75
001 042 100048 00 00	100X48 MM 90 L KÖŞE	8	ad.	9,87
001 044 100048 00 00	100X48 MM UÇ TAPA	20	ad.	4,36
001 043 100048 00 00	100X48 MM EK PARÇA	100	ad.	3,84
001 050 030004 00 00	100X48 MM KANAL KİLİTLEME APARATI	100	ad.	0,98
001 013 100048 20 00	100X48 MM ARA BÖLME	150	mt.	4,49
100X50 KANAL AKSESUARLARI  CE IP40				
001 039 100050 00 00	100X50 MM İÇ KÖŞE (SABİT)	8	ad.	5,78
001 040 100050 00 00	100X50 MM DIŞ KÖŞE (SABİT)	8	ad.	5,78
001 039 100050 01 00	100X50 MM İÇ KÖŞE (HAREKETLİ)	12	ad.	6,15
001 040 100050 01 00	100X50 MM DIŞ KÖŞE (HAREKETLİ)	10	ad.	6,37
001 041 100050 00 00	100X50 MM T PARÇASI	10	ad.	7,51
001 042 100050 00 00	100X50 MM 90 L KÖŞE	10	ad.	7,51
001 044 100050 00 00	100X50 MM UÇ TAPA	40	ad.	2,26
001 043 100050 00 00	100X50 MM EK PARÇA	100	ad.	2,86
001 043 100050 01 00	100X50 MM EK PARÇA (3LÜ SET)	100	ad.	2,96
001 046 195100 00 00	100X50 MM KANAL İÇİ KUP BUAT	25	ad.	5,38
100X50 KAİDESİZ KANAL AKSESUARLARI  CE IP40				
001 039 100051 00 00	100X50 MM KAİDESİZ İÇ KÖŞE	8	ad.	5,66
001 040 100051 00 00	100X50 MM KAİDESİZ DIŞ KÖŞE	8	ad.	5,72
001 041 100051 00 00	100X50 MM KAİDESİZ T PARÇASI	10	ad.	7,95
001 042 100051 00 00	100X50 MM KAİDESİZ 90 L KÖŞE	10	ad.	9,02
001 043 100051 00 00	100X50 MM KAİDESİZ EK PARÇA	100	ad.	3,84
001 044 100051 00 00	100X50 MM KAİDESİZ UÇ TAPA	40	ad.	3,48
001 888 100050 00 00	100X50 MM KABLO KANALI MONTAJ APARATI	50	mt.	3,46
100X60 KANAL AKSESUARLARI  CE IP40				
001 039 100060 00 00	100X60 MM İÇ KÖŞE (SABİT)	8	ad.	8,59
001 040 100060 00 00	100X60 MM DIŞ KÖŞE (SABİT)	8	ad.	9,33
001 039 100060 01 00	100X60 MM İÇ KÖŞE (HAREKETLİ)	8	ad.	7,89
001 040 100060 01 00	100X60 MM DIŞ KÖŞE (HAREKETLİ)	10	ad.	8,86
001 041 100060 00 00	100X60 MM T PARÇASI	8	ad.	10,86
001 042 100060 00 00	100X60 MM 90 L KÖŞE	8	ad.	9,70
001 044 100060 00 00	100X60 MM UÇ TAPA	20	ad.	2,07
001 043 100060 00 00	100X60 MM EK PARÇA	100	ad.	2,05
001 050 030004 00 00	100X60 MM KANAL KİLİTLEME APARATI	100	ad.	0,98
001 013 100060 20 00	100X60 MM ARA BÖLME	130	mt.	5,23
120X60 KANAL AKSESUARLARI  CE IP40				
001 039 120060 00 00	120X60 MM İÇ KÖŞE	8	ad.	8,22
001 040 120060 00 00	120X60 MM DIŞ KÖŞE	8	ad.	8,22
001 041 120060 00 00	120X60 MM T PARÇA	8	ad.	8,58
001 042 120060 00 00	120X60 MM 90 L KÖŞE	8	ad.	8,59
001 044 120060 00 00	120X60 MM UÇ TAPA	20	ad.	3,97
001 043 120060 00 00	120X60 MM EK PARÇA	50	ad.	3,92
170X50 KANAL AKSESUARLARI  CE IP40				
001 039 170050 00 00	170X50 MM İÇ KÖŞE	32	ad.	6,72
001 040 170050 00 00	170X50 MM DIŞ KÖŞE	8	ad.	6,23
001 041 170050 00 00	170X50 MM T PARÇA	16	ad.	8,49
001 042 170050 00 00	170X50 MM 90 L KÖŞE	16	ad.	6,92
001 044 170050 00 00	170X50 MM UÇ TAPA	125	ad.	2,25
001 043 170050 00 00	170X50 MM EK PARÇA	125	ad.	1,68
İÇTEN KAPAKLI 100X37/50 İÇİN PRİZ MONTAJ SETİ (45x45)  CE IP40				
001 047 070001 00 00	100X37/50 İÇİN 45X45 PMS (TEKLİ)	20	ad.	4,83
001 047 070002 00 00	100X37/50 İÇİN 45X45 PMS (İKİLİ)	14	ad.	5,99
001 047 070003 00 00	100X37/50 İÇİN 45X45 PMS (UÇLÜ)	12	ad.	6,67
001 047 070004 00 00	100X37/50 İÇİN 45X45 PMS (DÖRTLÜ)	10	ad.	10,26
İÇTEN KAPAKLI 100X37/50 İÇİN PRİZ MONTAJ SETİ (55X55)				
001 047 080001 00 00	100X37/50 İÇİN 55X55 PMS (TEKLİ)	20	ad.	6,41
001 047 080002 00 00	100X37/50 İÇİN 55X55 PMS (İKİLİ)	14	ad.	9,43
001 047 080003 00 00	100X37/50 İÇİN 55X55 PMS (UÇLÜ)	12	ad.	13,73
DIŞTAN KAPAKLI 100'LÜK KANAL PRİZ MONTAJ SETİ (55X55)				
001 047 020001 00 00	100'LÜK 55X55 PMS TEKLİ	20	ad.	8,62
001 047 020002 00 00	100'LÜK 55X55 PMS İKİLİ	14	ad.	11,94
001 047 020003 00 00	100'LÜK 55X55 PMS UÇLÜ	12	ad.	14,20
DIŞTAN KAPAKLI 100'LÜK KANAL PRİZ MONTAJ SETİ (45x45)  CE IP40				
001 047 040001 00 00	100'LÜK 45X45 PMS TEKLİ	20	ad.	7,29
001 047 040002 00 00	100'LÜK 45X45 PMS İKİLİ	14	ad.	10,47
001 047 040003 00 00	100'LÜK 45X45 PMS UÇLÜ	12	ad.	14,82
001 047 040004 00 00	100'LÜK 45X45 PMS DÖRTLÜ	10	ad.	16,45
İNGİLİZ NORMU PRİZ MONTAJ SETLERİ				
001 047 980001 00 00	İNGİLİZ NORMU TEKLİ PRİZ TABANI	200	ad.	4,52
001 047 980002 00 00	İNGİLİZ NORMU İKİLİ PRİZ TABANI	100	ad.	5,20
001 047 990002 00 00	İNGİLİZ NORMU İKİLİ YÜKSEK TİP PRİZ TABANI	94	ad.	7,78
001 166 000001 00 00	SIVA ALTI ANAHTAR KASASI	28	ad.	3,73

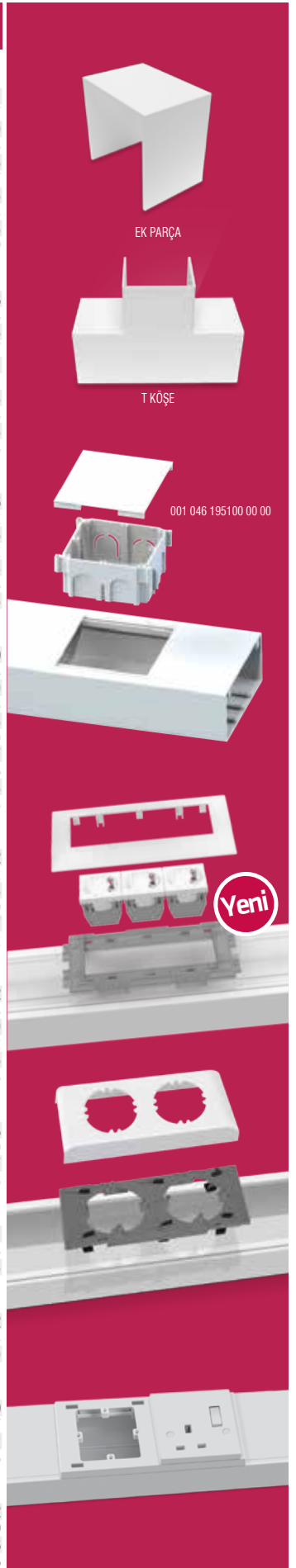

YENİ
ÜRÜNLERİMİZ



KANAL İÇİN UPS VE ENERJİ PRİZLERİ (45X45)



ÜRÜN KODU
001 052 300001 00 00
ÜRÜN ADI
45X45 TOP.P.ÇEKİRDEĞİ
ÇÇK.KOR.(45°)
AMBALAJ ADET / KOLİ
50
FİYAT
8,74 TL



ÜRÜN KODU
001 052 300002 00 00
ÜRÜN ADI
45X45 UPS P.ÇEKİRDEĞİ
ÇÇK.KOR.(45°)
AMBALAJ ADET / KOLİ
50
FİYAT
8,95 TL

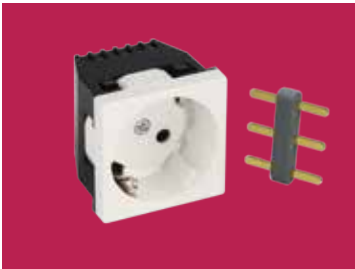

ÜRÜN KODU
001 052 200003 00 00
ÜRÜN ADI
45X45 PRİZ
BİRLEŞTİRME APARATI
(YANDAN)(YENİ)
AMBALAJ ADET / KOLİ
10
FİYAT
1,75 TL



ÜRÜN KODU
001 052 320001 00 00
ÜRÜN ADI
2'Lİ 45X45
TOP.P.ÇEKİRDEĞİ
ÇÇK.KOR.(45°)
AMBALAJ ADET / KOLİ
10
FİYAT
19,20 TL

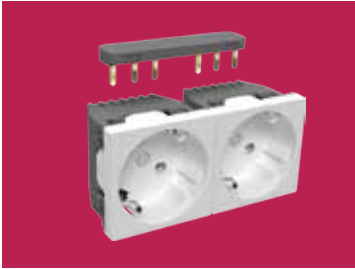

ÜRÜN KODU
001 052 200005 00 00
ÜRÜN ADI
45X45 PRİZ
BİRLEŞTİRME APARATI
AMBALAJ ADET / KOLİ
10
FİYAT
4,43 TL



ÜRÜN KODU
001 052 330001 00 00
ÜRÜN ADI
3'LÜ 45X45
TOP.P.ÇEKİRDEĞİ
ÇÇK.KOR.(45°)
AMBALAJ ADET / KOLİ
10
FİYAT
28,30 TL



ÜRÜN KODU
888 049 050040
ÜRÜN ADI
45X22,5 ANAHTAR
AMBALAJ KUTU / KOLİ
10/400
FİYAT
10,50 TL



ÜRÜN KODU
888 049 050043
ÜRÜN ADI
45X22,5 VAVİEN
AMBALAJ KUTU / KOLİ
10/400
FİYAT
17,00 TL



ÜRÜN KODU
888 049 050063
ÜRÜN ADI
45X45 ANAHTAR
AMBALAJ KUTU / KOLİ
25/250
FİYAT
21,00 TL



ÜRÜN KODU
888 049 050044
ÜRÜN ADI
45X45 YAYLI ÇAĞIRMA
(LIGHT)
AMBALAJ KUTU / KOLİ
25/250
FİYAT
25,00 TL



ÜRÜN KODU
888 049 050064
ÜRÜN ADI
45X45 ARA VAVİEN
AMBALAJ KUTU / KOLİ
25/250
FİYAT
30,00 TL



ÜRÜN KODU
888 049 050065
ÜRÜN ADI
45X45 VAVİEN
AMBALAJ KUTU / KOLİ
25/250
FİYAT
25,00 TL

KANAL İÇİN UPS VE ENERJİ PRİZLERİ (45X45)

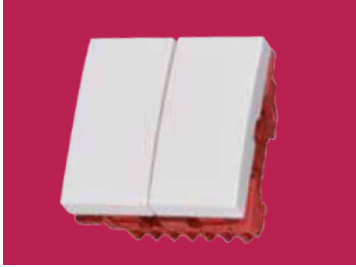

ÜRÜN KODU
888 049 050042
ÜRÜN ADI
45X45 KOMİTATÖR
AMBALAJ KUTU / KOLİ
25/250
FİYAT
25,00 TL



ÜRÜN KODU
888 049 050041
ÜRÜN ADI
45X45 ÇOK AMAÇLI
PRİZ
AMBALAJ KUTU / KOLİ
10/200
FİYAT
23,00 TL



ÜRÜN KODU
888 049 050058
ÜRÜN ADI
45X22,5 USB 2.0 - AF/AF
DATA 90 GİRİŞ
AMBALAJ KUTU / KOLİ
50/500
FİYAT
14,25 TL

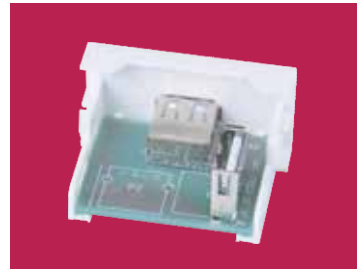

ÜRÜN KODU
888 049 050059
ÜRÜN ADI
45X22,5 USB 2.0 - AF/AF
DATA 180 GİRİŞ
AMBALAJ KUTU / KOLİ
50/500
FİYAT
14,25 TL



ÜRÜN KODU
888 049 050046
ÜRÜN ADI
45X22,5 HDMI 90 GİRİŞ
AMBALAJ KUTU / KOLİ
50/500
FİYAT
40,00 TL

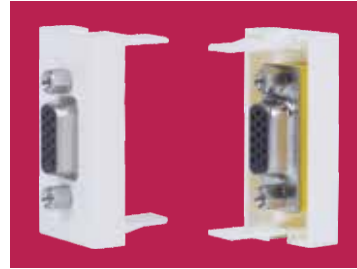

ÜRÜN KODU
888 049 050047
ÜRÜN ADI
45X22,5 VGA DATA
JACK
AMBALAJ KUTU / KOLİ
50/500
FİYAT
26,50 TL



ÜRÜN KODU
888 049 050056
ÜRÜN ADI
45X22,5 TV PRİZİ
ERKEK
AMBALAJ KUTU / KOLİ
50/500
FİYAT
16,15 TL



ÜRÜN KODU
888 049 050057
ÜRÜN ADI
45X22,5 TV PRİZİ DIŞI
AMBALAJ KUTU / KOLİ
50/500
FİYAT
14,25 TL



ÜRÜN KODU
888 049 050049
ÜRÜN ADI
45X22,5 RCA
AMBALAJ KUTU / KOLİ
50/500
FİYAT
40,00 TL



ÜRÜN KODU
888 049 050060
ÜRÜN ADI
45X22,5 SES JAKI 3,5 MM
STEREO
AMBALAJ KUTU / KOLİ
50/500
FİYAT
20,00 TL



ÜRÜN KODU
888 049 050051
ÜRÜN ADI
45X22,5 KÖR KAPAK
AMBALAJ KUTU / KOLİ
500/1000
FİYAT
2,00 TL



ÜRÜN KODU
888 049 050012
ÜRÜN ADI
45X22,5 KEYSTONE
JACK PANJURLU KAPAK
AMBALAJ KUTU / KOLİ
100/1000
FİYAT
5,00 TL

KANAL İÇİN UPS VE ENERJİ PRİZLERİ (45X45)



ÜRÜN KODU
888 049 050055
ÜRÜN ADI
45X45 KÖR KAPAK
AMBALAJ KUTU / KOLİ
500/1000
FİYAT
3,00 TL



ÜRÜN KODU
888 049 050013
ÜRÜN ADI
45X45 KEYSTONE JACK
PANJURLU KAPAK
AMBALAJ KUTU / KOLİ
250/500
FİYAT
7,50 TL



ÜRÜN KODU
888 049 050061
ÜRÜN ADI
45X22,5 USB ŞARJ
PRİZİ 5V 2,1A
AMBALAJ KUTU / KOLİ
10/200
FİYAT
82,00 TL



ÜRÜN KODU
888 049 050062
ÜRÜN ADI
45X22,5 2Lİ USB ŞARJ
PRİZİ 5V 2,1A
AMBALAJ KUTU / KOLİ
10/200
FİYAT
95,00 TL



ÜRÜN KODU
888 049 050066
ÜRÜN ADI
KEYSTONE JACK USB
DATA 2,0A
AMBALAJ KUTU / KOLİ
100/1000
FİYAT
15,00 TL



ÜRÜN KODU
888 049 050067
ÜRÜN ADI
KEYSTONE JACK USB
DATA 3,0A
AMBALAJ KUTU / KOLİ
100/1000
FİYAT
30,00 TL



ÜRÜN KODU
888 049 050068
ÜRÜN ADI
KEYSTONE JACK HDMI
AMBALAJ KUTU / KOLİ
50/500
FİYAT
30,00 TL



ÜRÜN KODU
888 049 050008
ÜRÜN ADI
DATA KONNEKTÖRÜ
CAT 5e (RJ65 8)
AMBALAJ ADET / KOLİ
10
FİYAT
1,53 USD



ÜRÜN KODU
888 049 050032
ÜRÜN ADI
DATA KONNEKTÖRÜ
CAT 6e (RJ65 8)
AMBALAJ ADET / KOLİ
10
FİYAT
2,20 USD



ÜRÜN KODU
888 049 050009
ÜRÜN ADI
TELEFON KONNEKTÖRÜ
(RJ 11/12 6)
AMBALAJ ADET / KOLİ
10
FİYAT
1,35 USD

Kod	Açıklama / Stok Cinsi	Amb. (Kutu)	Amb. Birimi	FİYAT
-----	-----------------------	-------------	-------------	-------

SİDEM SERİSİ RENKLİ KABLO KANALLARI

CE



001 007 010008 20 XX	10X8 MM KABLO KANALI (SİDEM)	330	mt.	5,83
001 007 012012 20 XX	12X12 MM KABLO KANALI (SİDEM)	250	mt.	5,74
001 007 015010 20 XX	15X10 MM KABLO KANALI (SİDEM)	250	mt.	5,47
001 007 016016 20 XX	16X16 MM KABLO KANALI (SİDEM)	250	mt.	7,45
001 007 020010 20 XX	20X10 MM KABLO KANALI (SİDEM)	200	mt.	6,14
001 007 025016 20 XX	25X16 MM KABLO KANALI (SİDEM)	150	mt.	8,99
001 007 025025 20 XX	25X25 MM KABLO KANALI (SİDEM)	100	mt.	11,96
001 007 930010 20 XX	30X10 MM KABLO KANALI (SİDEM) BÖLMELİ	140	mt.	8,82
001 007 930016 20 XX	30X16 MM KABLO KANALI (SİDEM) BÖLMELİ	140	mt.	11,05
001 007 030025 20 XX	30X25 MM KABLO KANALI (SİDEM)	80	mt.	13,73
001 007 040016 20 XX	40X16 MM KABLO KANALI (SİDEM)	100	mt.	12,03
001 007 940016 20 XX	40X16 MM KABLO KANALI (SİDEM) (BÖLMELİ)	100	mt.	12,86
001 007 040025 20 XX	40X25 MM KABLO KANALI (SİDEM)	80	mt.	15,36
001 007 040040 20 XX	40X40 MM KABLO KANALI (SİDEM)	50	mt.	18,56
001 007 960025 20 XX	60X25 MM KABLO KANALI (SİDEM) BÖLMELİ	40	mt.	24,51
001 007 060040 20 XX	60X40 MM KABLO KANALI (SİDEM)	40	mt.	23,00
001 007 060060 20 XX	60X60 MM KABLO KANALI (SİDEM)	32	mt.	34,64
001 007 080040 20 XX	80X40 MM KABLO KANALI (SİDEM)	30	mt.	33,29
001 007 080060 20 XX	80X60 MM KABLO KANALI (SİDEM)	24	mt.	37,83
001 007 100036 20 XX	100X36 MM KABLO KANALI (SİDEM)	30	mt.	41,98
001 007 100040 20 XX	100X40 MM KABLO KANALI (SİDEM)	24	mt.	37,45
001 007 100048 20 XX	100X48 MM KABLO KANALI (SİDEM)	24	mt.	47,04
001 007 100060 20 XX	100X60 MM KABLO KANALI (SİDEM)	20	mt.	49,90
001 007 075060 20 XX	75X60 MM KABLO KANALI (SİDEM)	30	mt.	36,93
001 007 100037 20 XX	100X37 MM KABLO KANALI (SİDEM) İ.KAPAKLI	30	mt.	44,07
001 007 100050 20 XX	100X50 MM KABLO KANALI (SİDEM) İ.KAPAKLI	20	mt.	47,75
001 007 120060 20 XX	120X60 MM KABLO KANALI (SİDEM) İ.KAPAKLI	16	mt.	60,76
001 007 120070 20 XX	120X70 MM KABLO KANALI (SİDEM)	16	mt.	82,93
001 007 170070 20 XX	170X70 MM KABLO KANALI (SİDEM)	12	mt.	94,26

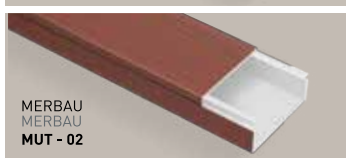
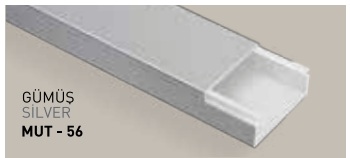
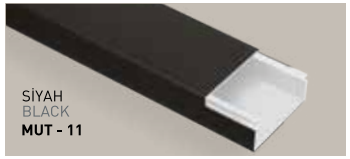

SİDEM SERİSİ RENKLİ KABLO KANALLARI (YAPIŞKANLI)



001 155 010008 20 XX	10X8 MM KABLO KANALI (SİDEM) YAPIŞKANLI	330	mt.	6,21
001 155 012012 20 XX	12X12 MM KABLO KANALI (SİDEM) YAPIŞKANLI	250	mt.	5,99
001 155 015010 20 XX	15X10 MM KABLO KANALI (SİDEM) YAPIŞKANLI	250	mt.	6,56
001 155 016016 20 XX	16X16 MM KABLO KANALI (SİDEM) YAPIŞKANLI	240	mt.	7,79
001 155 020010 20 XX	20X10 MM KABLO KANALI (SİDEM) YAPIŞKANLI	180	mt.	6,72
001 155 025016 20 XX	25X16 MM KABLO KANALI (SİDEM) YAPIŞKANLI	150	mt.	9,61
001 155 025025 20 XX	25X25 MM KABLO KANALI (SİDEM) YAPIŞKANLI	100	mt.	12,99
001 155 930010 20 XX	30X10 MM KABLO KANALI (SİDEM) YAPIŞKANLI	140	mt.	8,15
001 155 930016 20 XX	30X16 MM KABLO KANALI (SİDEM) YAPIŞKANLI	140	mt.	11,33
001 155 030025 20 XX	30X25 MM KABLO KANALI (SİDEM) YAPIŞKANLI	80	mt.	14,05
001 155 040016 20 XX	40X16 MM KABLO KANALI (SİDEM) YAPIŞKANLI	100	mt.	19,09
001 155 040025 20 XX	40X25 MM KABLO KANALI (SİDEM) YAPIŞKANLI	80	mt.	17,14
001 155 040040 20 XX	40X40 MM KABLO KANALI (SİDEM) YAPIŞKANLI	50	mt.	20,21
001 155 960025 20 XX	60X25 MM KABLO KANALI (SİDEM) YAPIŞKANLI	40	mt.	24,83
001 155 060040 20 XX	60X40 MM KABLO KANALI (SİDEM) YAPIŞKANLI	40	mt.	26,80



SİDEM SERİSİ SÜPÜRGELİKLER VE AKSESUARLARI



001 007 974020 20 XX	74X20 MM KABLO KANALI (SİDEM) BÖLMELİ	50	mt.	18,67
001 007 975022 20 XX	75X22 MM KABLO KANALI (SİDEM) BÖLMELİ	50	mt.	29,17



SİDEM SERİSİ BALIK SIRTI ZEMİN KANALLARI VE AKSESUARLARI

001 007 050013 20 XX	50X13 MM KABLO KANALI (SİDEM)	60	mt.	23,33
001 007 060015 20 XX	60X15 MM KABLO KANALI (SİDEM)	40	mt.	17,27
001 031 060015 00 XX	60X15 MM L KÖŞE (SİDEM)	1	ad.	7,65
001 032 060015 00 XX	60X15 MM EK PARÇA (SİDEM)	1	ad.	4,19
001 033 060015 00 XX	60X15 MM SONLAMA KAPAĞI (SİDEM)	1	ad.	4,19
001 030 060015 00 XX	60X15 MM T KÖŞE (SİDEM)	1	ad.	7,95
001 007 075018 20 XX	75X18 MM KABLO KANALI (SİDEM)	30	mt.	26,21
001 007 090020 20 XX	90X20 MM KABLO KANALI (SİDEM)	20	mt.	39,13



SİDEM SERİSİ BALIK SIRTI ZEMİN KANALLARI (YAPIŞKANLI)

001 155 050013 20 XX	50X13 MM KABLO KANALI (SİDEM) YAPIŞKANLI	60	mt.	28,53
001 155 060015 20 XX	60X15 MM KABLO KANALI (SİDEM) YAPIŞKANLI	80	mt.	19,96
001 155 075018 20 XX	75X18 MM KABLO KANALI (SİDEM) YAPIŞKANLI	60	mt.	30,23



12X12 KANAL AKSESUARLARI (SİDEM SERİSİ)

CE

001 028 012012 00 XX	12X12 MM (SİDEM) İÇ KÖŞE	1	ad.	2,35
001 029 012012 00 XX	12X12 MM (SİDEM) DIŞ KÖŞE	1	ad.	2,35
001 030 012012 00 XX	12X12 MM (SİDEM) T KÖŞE	1	ad.	2,48
001 031 012012 00 XX	12X12 MM (SİDEM) 90 L KÖŞE	1	ad.	2,48
001 033 012012 00 XX	12X12 MM (SİDEM) UÇ TAPA	1	ad.	3,90
001 032 012012 00 XX	12X12 MM (SİDEM) EK PARÇASI	1	ad.	3,90



15X10 KANAL AKSESUARLARI (SİDEM SERİSİ)

CE

001 028 015010 00 XX	15X10 MM (SİDEM) İÇ KÖŞE	1	ad.	2,35
001 029 015010 00 XX	15X10 MM (SİDEM) DIŞ KÖŞE	1	ad.	2,35
001 030 015010 00 XX	15X10 MM (SİDEM) T KÖŞE	1	ad.	2,59
001 031 015010 00 XX	15X10 MM (SİDEM) 90 L KÖŞE	1	ad.	2,59
001 033 015010 00 XX	15X10 MM (SİDEM) UÇ TAPA	1	ad.	3,76
001 032 015010 00 XX	15X10 MM (SİDEM) EK PARÇASI	1	ad.	3,76





Kod	Açıklama / Stok Cinsi	Amb. (Kutu)	Amb. Birimi	FİYAT
16X16 KANAL AKSESUARLARI (SİDEM SERİSİ) C€				
001 028 016016 00 XX	16X16 MM (SİDEM) İÇ KÖŞE	1	ad.	2,55
001 029 016016 00 XX	16X16 MM (SİDEM) DIŞ KÖŞE	1	ad.	2,55
001 030 016016 00 XX	16X16 MM (SİDEM) T KÖŞE	1	ad.	2,83
001 031 016016 00 XX	16X16 MM (SİDEM) 90 L KÖŞE	1	ad.	2,83
001 033 016016 00 XX	16X16 MM (SİDEM) UÇ TAPA	1	ad.	3,01
001 032 016016 00 XX	16X16 MM (SİDEM) EK PARÇASI	1	ad.	3,01
20X10 KANAL AKSESUARLARI (SİDEM SERİSİ) C€				
001 028 020010 00 XX	20X10 MM (SİDEM) İÇ KÖŞE	1	ad.	2,51
001 029 020010 00 XX	20X10 MM (SİDEM) DIŞ KÖŞE	1	ad.	2,51
001 030 020010 00 XX	20X10 MM (SİDEM) T KÖŞE	1	ad.	2,63
001 031 020010 00 XX	20X10 MM (SİDEM) 90 L KÖŞE	1	ad.	2,63
001 033 020010 00 XX	20X10 MM (SİDEM) UÇ TAPA	1	ad.	3,05
001 032 020010 00 XX	20X10 MM (SİDEM) EK PARÇASI	1	ad.	3,05
TAVAN KÖŞE KANALI (23X23) AKSESUARLARI (SİDEM SERİSİ) C€				
001 041 023023 00 XX	23X23 MM T PARÇASI	1	ad.	6,37
001 042 023023 00 XX	23X23 MM 90 L KÖŞE	1	ad.	5,18
001 043 023023 00 XX	23X23 MM EK PARÇA	1	ad.	1,66
001 044 023023 00 XX	23X23 MM UÇ TAPA	1	ad.	1,19
25X16 KANAL AKSESUARLARI (SİDEM SERİSİ) C€				
001 028 025016 00 XX	25X16 MM (SİDEM) İÇ KÖŞE	1	ad.	3,01
001 029 025016 00 XX	25X16 MM (SİDEM) DIŞ KÖŞE	1	ad.	3,01
001 030 025016 00 XX	25X16 MM (SİDEM) T KÖŞE	1	ad.	3,49
001 031 025016 00 XX	25X16 MM (SİDEM) 90 L KÖŞE	1	ad.	3,49
001 033 025016 00 XX	25X16 MM (SİDEM) UÇ TAPA	1	ad.	3,43
001 032 025016 00 XX	25X16 MM (SİDEM) EK PARÇA	1	ad.	3,43
001 034 017421 00 XX	25X16 MM (SİDEM) PMK (45X45)	1	ad.	26,52
25X25 KANAL AKSESUARLARI (SİDEM SERİSİ) C€				
001 028 025025 00 XX	25X25 MM (SİDEM) İÇ KÖŞE	1	ad.	3,67
001 029 025025 00 XX	25X25 MM (SİDEM) DIŞ KÖŞE	1	ad.	3,67
001 030 025025 00 XX	25X25 MM (SİDEM) T PARÇASI	1	ad.	4,38
001 031 025025 00 XX	25X25 MM (SİDEM) 90 L KÖŞE	1	ad.	4,38
001 033 025025 00 XX	25X25 MM (SİDEM) UÇ TAPA	1	ad.	4,12
001 032 025025 00 XX	25X25 MM (SİDEM) EK PARÇA	1	ad.	4,12
001 034 017421 00 XX	25X25 MM (SİDEM) PMK (45X45)	1	ad.	26,52
30X10 KANAL AKSESUARLARI (SİDEM SERİSİ) C€				
001 028 030010 00 XX	30X10 MM (SİDEM) İÇ KÖŞE	1	ad.	5,77
001 029 030010 00 XX	30X10 MM (SİDEM) DIŞ KÖŞE	1	ad.	5,77
001 030 030010 00 XX	30X10 MM (SİDEM) T PARÇASI	1	ad.	5,46
001 031 030010 00 XX	30X10 MM (SİDEM) 90 L KÖŞE	1	ad.	5,09
001 033 030010 00 XX	30X10 MM (SİDEM) UÇ TAPA	1	ad.	3,82
001 032 030010 00 XX	30X10 MM (SİDEM) EK PARÇA	1	ad.	3,82
30X16 KANAL AKSESUARLARI (SİDEM SERİSİ) C€				
001 028 030016 00 XX	30X16 MM (SİDEM) İÇ KÖŞE	1	ad.	6,39
001 029 030016 00 XX	30X16 MM (SİDEM) DIŞ KÖŞE	1	ad.	6,39
001 030 030016 00 XX	30X16 MM (SİDEM) T PARÇASI	1	ad.	5,86
001 031 030016 00 XX	30X16 MM (SİDEM) 90 L KÖŞE	1	ad.	5,86
001 033 030016 00 XX	30X16 MM (SİDEM) UÇ TAPA	1	ad.	4,05
001 032 030016 00 XX	30X16 MM (SİDEM) EK PARÇA	1	ad.	4,05
30X25 KANAL AKSESUARLARI (SİDEM SERİSİ) C€				
001 028 030025 00 XX	30X25 MM (SİDEM) İÇ KÖŞE	1	ad.	6,81
001 029 030025 00 XX	30X25 MM (SİDEM) DIŞ KÖŞE	1	ad.	6,81
001 030 030025 00 XX	30X25 MM (SİDEM) T PARÇASI	1	ad.	6,20
001 031 030025 00 XX	30X25 MM (SİDEM) 90 L KÖŞE	1	ad.	6,20
001 033 030025 00 XX	30X25 MM (SİDEM) UÇ TAPA	1	ad.	4,41
001 032 030025 00 XX	30X25 MM (SİDEM) EK PARÇA	1	ad.	4,41
40X16 KANAL AKSESUARLARI (SİDEM SERİSİ) C€				
001 028 040016 00 XX	40X16 MM (SİDEM) İÇ KÖŞE	1	ad.	6,20
001 029 040016 00 XX	40X16 MM (SİDEM) DIŞ KÖŞE	1	ad.	6,24
001 030 040016 00 XX	40X16 MM (SİDEM) T KÖŞE	1	ad.	4,62
001 031 040016 00 XX	40X16 MM (SİDEM) 90 L KÖŞE	1	ad.	4,62
001 033 040016 00 XX	40X16 MM (SİDEM) UÇ TAPA	1	ad.	5,31
001 032 040016 00 XX	40X16 MM (SİDEM) EK PARÇASI	1	ad.	5,31
001 034 017421 00 XX	40X16 MM (SİDEM) PMK (45X45)	1	ad.	26,52
40X25 KANAL AKSESUARLARI (SİDEM SERİSİ) C€				
001 028 040025 00 XX	40X25 MM (SİDEM) İÇ KÖŞE	1	ad.	4,91
001 029 040025 00 XX	40X25 MM (SİDEM) DIŞ KÖŞE	1	ad.	4,91
001 030 040025 00 XX	40X25 MM (SİDEM) T KÖŞE	1	ad.	5,62
001 031 040025 00 XX	40X25 MM (SİDEM) 90 L KÖŞE	1	ad.	5,62
001 033 040025 00 XX	40X25 MM (SİDEM) UÇ TAPA	1	ad.	5,07
001 032 040025 00 XX	40X25 MM (SİDEM) EK PARÇASI	1	ad.	5,07
001 034 017421 00 XX	40X25 MM (SİDEM) PMK (45X45)	1	ad.	26,52

Kod	Açıklama / Stok Cinsi	Amb. (Kutu)	Amb. Birimi	FİYAT
40X40 KANAL AKSESUARLARI (SİDEM SERİSİ) CE				
001 028 040040 00 XX	40X40 MM (SİDEM) İÇ KÖŞE	1	ad.	8,65
001 029 040040 00 XX	40X40 MM (SİDEM) DIŞ KÖŞE	1	ad.	8,65
001 030 040040 00 XX	40X40 MM (SİDEM) T PARÇASI	1	ad.	6,98
001 031 040040 00 XX	40X40 MM (SİDEM) 90 L KÖŞE	1	ad.	6,98
001 033 040040 00 XX	40X40 MM (SİDEM) UÇ TAPA	1	ad.	6,47
001 032 040040 00 XX	40X40 MM (SİDEM) EK PARÇA	1	ad.	6,47
001 034 017421 00 XX	40X40 MM (SİDEM) PMK (45X45)	1	ad.	26,52
60X25 KANAL AKSESUARLARI (SİDEM SERİSİ) CE				
001 028 060025 00 XX	60X25 MM (SİDEM) İÇ KÖŞE	1	ad.	7,58
001 029 060025 00 XX	60X25 MM (SİDEM) DIŞ KÖŞE	1	ad.	7,58
001 030 060025 00 XX	60X25 MM (SİDEM) T PARÇASI	1	ad.	7,88
001 031 060025 00 XX	60X25 MM (SİDEM) 90 L KÖŞE	1	ad.	7,88
001 033 060025 00 XX	60X25 MM (SİDEM) UÇ TAPA	1	ad.	10,01
001 032 060025 00 XX	60X25 MM (SİDEM) EK PARÇA	1	ad.	10,01
60X40 KANAL AKSESUARLARI (SİDEM SERİSİ) CE				
001 028 060040 00 XX	60X40 MM (SİDEM) İÇ KÖŞE	1	ad.	10,44
001 029 060040 00 XX	60X40 MM (SİDEM) DIŞ KÖŞE	1	ad.	10,44
001 030 060040 00 XX	60X40 MM (SİDEM) T PARÇASI	1	ad.	8,38
001 031 060040 00 XX	60X40 MM (SİDEM) 90 L KÖŞE	1	ad.	8,38
001 033 060040 00 XX	60X40 MM (SİDEM) UÇ TAPA	1	ad.	10,42
001 032 060040 00 XX	60X40 MM (SİDEM) EK PARÇA	1	ad.	10,42
60X60 KANAL AKSESUARLARI (SİDEM SERİSİ) CE				
001 028 060060 00 XX	60X60 MM (SİDEM) İÇ KÖŞE	1	ad.	10,44
001 029 060060 00 XX	60X60 MM (SİDEM) DIŞ KÖŞE	1	ad.	10,44
001 030 060060 00 XX	60X60 MM (SİDEM) T PARÇASI	1	ad.	13,01
001 031 060060 00 XX	60X60 MM (SİDEM) 90 L KÖŞE	1	ad.	13,01
001 033 060060 00 XX	60X60 MM (SİDEM) UÇ TAPA	1	ad.	9,53
001 032 060060 00 XX	60X60 MM (SİDEM) EK PARÇA	1	ad.	9,53
74X20 KANAL AKSESUARLARI (SİDEM SERİSİ) CE				
001 028 074020 00 XX	74X20 MM (SİDEM) İÇ KÖŞE	1	ad.	8,39
001 029 074020 00 XX	74X20 MM (SİDEM) DIŞ KÖŞE	1	ad.	6,95
001 030 074020 00 XX	74X20 MM (SİDEM) T KÖŞE	1	ad.	7,84
001 031 074020 00 XX	74X20 MM (SİDEM) 90 L KÖŞE	1	ad.	8,65
001 032 074020 00 XX	74X20 MM (SİDEM) EK PARÇA	1	ad.	4,41
001 033 074020 00 XX	74X20 MM (SİDEM) UÇ TAPA	1	ad.	5,00
001 036 017420 00 XX	74X20 MM (SİDEM) PRİZ MONTAJ KASASI	1	ad.	39,61
75X22 KANAL AKSESUARLARI (SİDEM SERİSİ) CE				
001 028 075022 00 XX	75X22 MM (SİDEM) İÇ KÖŞE	1	ad.	6,70
001 029 075022 00 XX	75X22 MM (SİDEM) DIŞ KÖŞE	1	ad.	6,70
001 033 075022 01 XX	75X22 MM (SİDEM) SAĞ SONLAMA	1	ad.	6,19
001 033 075022 02 XX	75X22 MM (SİDEM) SOL SONLAMA	1	ad.	6,19
001 032 075022 00 XX	75X22 MM (SİDEM) EK PARÇASI	1	ad.	6,46
80X40 KANAL AKSESUARLARI (SİDEM SERİSİ) CE				
001 028 080040 00 XX	80X40 MM (SİDEM) İÇ KÖŞE	1	ad.	13,72
001 029 080040 00 XX	80X40 MM (SİDEM) DIŞ KÖŞE	1	ad.	13,72
001 030 080040 00 XX	80X40 MM (SİDEM) T PARÇASI	1	ad.	14,25
001 031 080040 00 XX	80X40 MM (SİDEM) 90 L KÖŞE	1	ad.	14,25
001 033 080040 00 XX	80X40 MM (SİDEM) UÇ TAPA	1	ad.	8,29
001 032 080040 00 XX	80X40 MM (SİDEM) EK PARÇA	1	ad.	8,29
80X60 KANAL AKSESUARLARI (SİDEM SERİSİ) CE				
001 028 080060 00 XX	80X60 MM (SİDEM) İÇ KÖŞE	1	ad.	16,94
001 029 080060 00 XX	80X60 MM (SİDEM) DIŞ KÖŞE	1	ad.	16,94
001 030 080060 00 XX	80X60 MM (SİDEM) T PARÇASI	1	ad.	17,35
001 031 080060 00 XX	80X60 MM (SİDEM) 90 L KÖŞE	1	ad.	17,35
001 033 080060 00 XX	80X60 MM (SİDEM) UÇ TAPA	1	ad.	11,45
001 032 080060 00 XX	80X60 MM (SİDEM) EK PARÇA	1	ad.	11,45
100X36 KANAL AKSESUARLARI (SİDEM SERİSİ) CE				
001 028 100036 00 XX	100X36 MM (SİDEM) İÇ KÖŞE (SABİT)	1	ad.	15,23
001 029 100036 00 XX	100X36 MM (SİDEM) DIŞ KÖŞE (SABİT)	1	ad.	15,23
001 028 100036 01 XX	100X36 MM (SİDEM) İÇ KÖŞE (HARKT)	1	ad.	15,23
001 029 100036 01 XX	100X36 MM (SİDEM) DIŞ KÖŞE (HARKT)	1	ad.	15,23
001 030 100036 00 XX	100X36 MM (SİDEM) T PARÇASI	1	ad.	15,73
001 031 100036 00 XX	100X36 MM (SİDEM) 90 L KÖŞE	1	ad.	15,73
001 033 100036 00 XX	100X36 MM (SİDEM) UÇ TAPA	1	ad.	9,70
001 032 100036 00 XX	100X36 MM (SİDEM) EK PARÇA	1	ad.	9,70



İÇ KÖŞE



DIŞ KÖŞE



T KÖŞE



L KÖŞE



EK PARÇA



UÇ TAPA

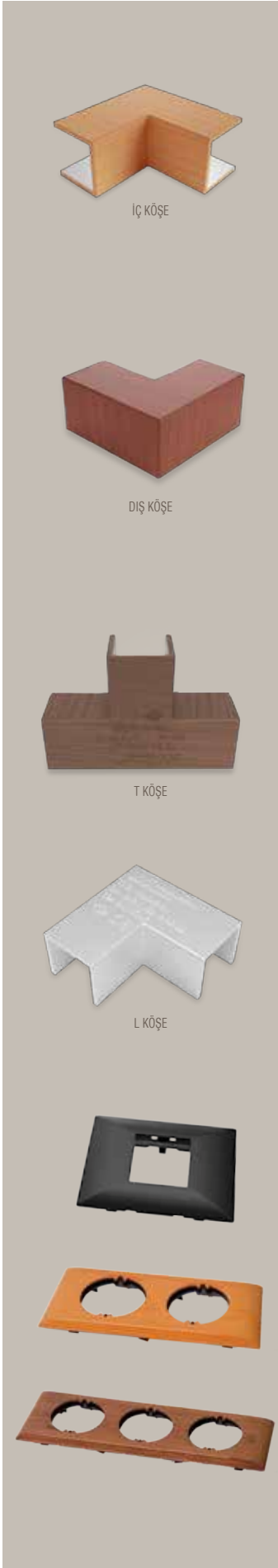

Kod	Açıklama / Stok Cinsi	Amb. (Kutu)	Amb. Birimi	FİYAT
100X37 KANAL AKSESUARLARI (SİDEM SERİSİ)				
C €				
001 028 100037 00 XX	100X37 MM (SİDEM) İÇ KÖŞE (SABİT)	1	ad.	12,28
001 029 100037 00 XX	100X37 MM (SİDEM) DIŞ KÖŞE (SABİT)	1	ad.	12,28
001 028 100037 01 XX	100X37 MM (SİDEM) İÇ KÖŞE (HARKT)	1	ad.	12,36
001 029 100037 01 XX	100X37 MM (SİDEM) DIŞ KÖŞE (HARKT)	1	ad.	12,36
001 030 100037 00 XX	100X37 MM (SİDEM) T PARÇASI	1	ad.	12,35
001 031 100037 00 XX	100X37 MM (SİDEM) 90 L KÖŞE	1	ad.	12,35
001 033 100037 00 XX	100X37 MM (SİDEM) UÇ TAPA	1	ad.	10,20
001 032 100037 00 XX	100X37 MM (SİDEM) EK PARÇA	1	ad.	10,20
100X40 KANAL AKSESUARLARI (SİDEM SERİSİ)				
C €				
001 028 100040 00 XX	100X40 MM (SİDEM) İÇ KÖŞE (SABİT)	1	ad.	15,57
001 029 100040 00 XX	100X40 MM (SİDEM) DIŞ KÖŞE (SABİT)	1	ad.	15,57
001 028 100040 01 XX	100X40 MM (SİDEM) İÇ KÖŞE (HARKT)	1	ad.	15,57
001 029 100040 01 XX	100X40 MM (SİDEM) DIŞ KÖŞE (HARKT)	1	ad.	15,57
001 030 100040 00 XX	100X40 MM (SİDEM) T PARÇASI	1	ad.	16,20
001 031 100040 00 XX	100X40 MM (SİDEM) 90 L KÖŞE	1	ad.	16,20
001 033 100040 00 XX	100X40 MM (SİDEM) UÇ TAPA	1	ad.	9,94
001 032 100040 00 XX	100X40 MM (SİDEM) EK PARÇA	1	ad.	9,94
100X48 KANAL AKSESUARLARI (SİDEM SERİSİ)				
C €				
001 028 100048 00 XX	100X48 MM (SİDEM) İÇ KÖŞE (SABİT)	1	ad.	16,46
001 029 100048 00 XX	100X48 MM (SİDEM) DIŞ KÖŞE (SABİT)	1	ad.	16,46
001 028 100048 01 XX	100X48 MM (SİDEM) İÇ KÖŞE (HARKT)	1	ad.	16,46
001 029 100048 01 XX	100X48 MM (SİDEM) DIŞ KÖŞE (HARKT)	1	ad.	16,46
001 030 100048 00 XX	100X48 MM (SİDEM) T PARÇASI	1	ad.	17,44
001 031 100048 00 XX	100X48 MM (SİDEM) 90 L KÖŞE	1	ad.	17,44
001 033 100048 00 XX	100X48 MM (SİDEM) UÇ TAPA	1	ad.	10,98
001 032 100048 00 XX	100X48 MM (SİDEM) EK PARÇA	1	ad.	10,98
100X50 KANAL AKSESUARLARI (SİDEM SERİSİ)				
C €				
001 028 100050 00 XX	100X50 MM (SİDEM) İÇ KÖŞE (SABİT)	1	ad.	13,90
001 029 100050 00 XX	100X50 MM (SİDEM) DIŞ KÖŞE (SABİT)	1	ad.	13,90
001 028 100050 01 XX	100X50 MM (SİDEM) İÇ KÖŞE (HARKT)	1	ad.	13,90
001 029 100050 01 XX	100X50 MM (SİDEM) DIŞ KÖŞE (HARKT)	1	ad.	13,90
001 030 100050 00 XX	100X50 MM (SİDEM) T PARÇASI	1	ad.	15,84
001 031 100050 00 XX	100X50 MM (SİDEM) 90 L KÖŞE	1	ad.	15,84
001 033 100050 00 XX	100X50 MM (SİDEM) UÇ TAPA	1	ad.	11,43
001 032 100050 00 XX	100X50 MM (SİDEM) EK PARÇA	1	ad.	11,43
100X60 KANAL AKSESUARLARI (SİDEM SERİSİ)				
C €				
001 028 100060 00 XX	100X60 MM (SİDEM) İÇ KÖŞE (SABİT)	1	ad.	16,97
001 029 100060 00 XX	100X60 MM (SİDEM) DIŞ KÖŞE (SABİT)	1	ad.	16,97
001 028 100060 01 XX	100X60 MM (SİDEM) İÇ KÖŞE (HARKT)	1	ad.	16,97
001 029 100060 01 XX	100X60 MM (SİDEM) DIŞ KÖŞE (HARKT)	1	ad.	16,97
001 030 100060 00 XX	100X60 MM (SİDEM) T PARÇASI	1	ad.	19,20
001 031 100060 00 XX	100X60 MM (SİDEM) 90 L KÖŞE	1	ad.	19,20
001 033 100060 00 XX	100X60 MM (SİDEM) UÇ TAPA	1	ad.	11,75
001 032 100060 00 XX	100X60 MM (SİDEM) EK PARÇA	1	ad.	11,75
İÇTEN KAPAKLI 100X37/50 İÇİN PMS (SİDEM SERİSİ)				
001 034 400001 00 XX	100X37/50 (SİDEM) 45X45 PMS TEKLİ	1	ad.	10,17
001 034 400002 00 XX	100X37/50 (SİDEM) 45X45 PMS İKİLİ	1	ad.	11,55
001 034 400003 00 XX	100X37/50 (SİDEM) 45X45 PMS ÜÇLÜ	1	ad.	11,78
001 034 400004 00 XX	100X37/50 (SİDEM) 45X45 PMS DÖRTLÜ	1	ad.	16,98
001 034 500001 00 XX	100X37/50 (SİDEM) 55X55 PMS TEKLİ	1	ad.	12,23
001 034 500002 00 XX	100X37/50 (SİDEM) 55X55 PMS İKİLİ	1	ad.	14,71
001 034 500003 00 XX	100X37/50 (SİDEM) 55X55 PMS ÜÇLÜ	1	ad.	19,73
DIŞTAN KAPAKLI 100'LÜK PMS (55X55 İÇİN) (SİDEM SERİSİ)				
001 034 000001 00 XX	100'LÜK 55X55 PMS TEKLİ SİDEM	1	ad.	15,70
001 034 000002 00 XX	100'LÜK 55X55 PMS İKİLİ SİDEM	1	ad.	20,38
001 034 000003 00 XX	100'LÜK 55X55 PMS ÜÇLÜ SİDEM	1	ad.	23,06
DIŞTAN KAPAKLI 100'LÜK SERİ PMS (45X45 İÇİN) (SİDEM SERİSİ)				
001 034 100001 00 XX	100'LÜK 45X45 PMS TEKLİ SİDEM	1	ad.	12,05
001 034 100002 00 XX	100'LÜK 45X45 PMS İKİLİ SİDEM	1	ad.	15,88
001 034 100003 00 XX	100'LÜK 45X45 PMS ÜÇLÜ SİDEM	1	ad.	21,01
001 034 100004 00 XX	100'LÜK 45X45 PMS DÖRTLÜ SİDEM	1	ad.	23,54

YENİ
ÜRÜNLERİMİZ

SİLİNDİR ve MASA ÜSTÜ BAS-AÇ

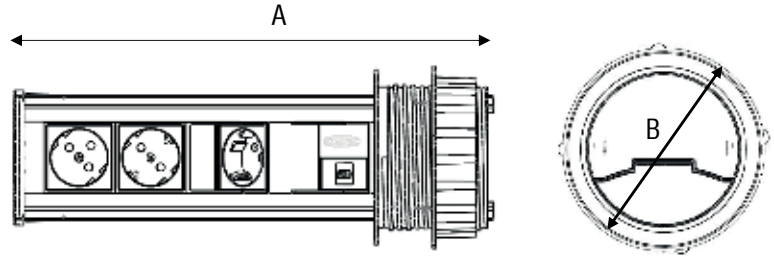

Ürün Kodu	Açıklama	Modül Sayısı	Ürün Ölçüsü (mm)	Yuva Ölçüsü	Fiyat
888 020 200101	Silindir Bas-Aç (Boş)	6 (45x22,5)	A:280 B:120	Ø100	178,51
888 020 200102	Silindir Bas-Aç (Boş)	8 (45x22,5)	A:330 B:120	Ø100	197,30
888 020 200103	Silindir Bas-Aç (Boş)	10 (45x22,5)	A:380 B:120	Ø100	209,83

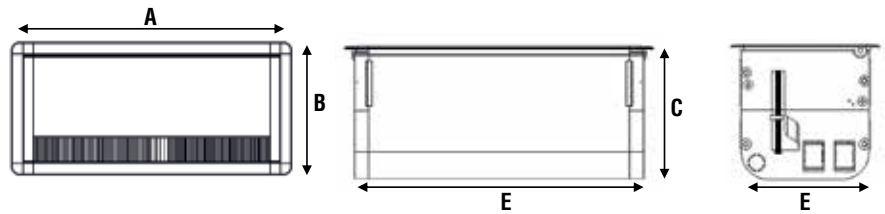

Ürün Kodu	Açıklama	Modül Sayısı	Ürün Ölçüsü (mm)	Yuva Ölçüsü	Fiyat
888 020 200201	Masa Üstü Bas-Aç (Boş)	5(45x22,5)	A:166 B:100 C:112	D:156 E:98	97,08
888 020 200202	Masa Üstü Bas-Aç (Boş)	8 (45x22,5)	A:234 B:100 C:112	D:225 E:98	125,27
888 020 200203	Masa Üstü Bas-Aç (Boş)	10 (45x22,5)	A:301 B:100 C:112	D:293 E:98	144,06
888 020 200204	Masa Üstü Bas-Aç (Boş)	12 (45x22,5)	A:323 B:100 C:112	D:315 E:98	159,72
888 020 200205	Masa Üstü Bas-Aç (Boş)	14 (45x22,5)	A:368 B:100 C:112	D:360 E:98	178,51
888 020 200206	Masa Üstü Bas-Aç (Boş)	16 (45x22,5)	A:413 B:100 C:112	D:405 E:98	197,30
888 020 200207	Masa Üstü Bas-Aç (Boş)	18 (45x22,5)	A:458 B:100 C:112	D:450 E:98	208,26



ALÜMİNYUM VE PLASTİĞİN
MÜKEMMEL UYUMU VE
FONKSİYONELLİĞİ
BİR ARADA

ALT PRİZ ÇIKIŞ KAPAĞI
SAYESİNDE PRATİK MODÜL
BAĞLANTISI

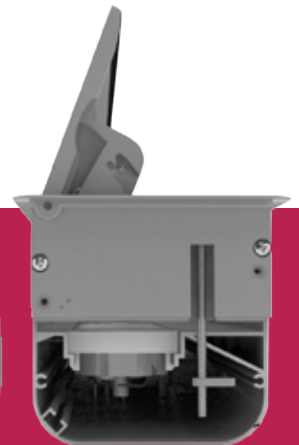

ALÜMİNYUM BÜROKİT BLOK ve DÖŞEME ALTI BUATLAR



Ürün Kodu	Açıklama	Ürün Ölçüsü En x Boy x Yükseklik(mm)	Fiyat
888 020 200301	2 Modül Slim Alüminyum Bürokit Blok (Boş)	50 x 90 x 50	24,20
888 020 200302	4 Modül Slim Alüminyum Bürokit Blok (Boş)	50 x 135 x 50	27,05
888 020 200303	6 Modül Slim Alüminyum Bürokit Blok (Boş)	50 x 180 x 50	31,32
888 020 200304	8 Modül Slim Alüminyum Bürokit Blok (Boş)	50 x 225 x 50	39,86
888 020 200305	10 Modül Slim Alüminyum Bürokit Blok (Boş)	50 x 270 x 50	42,71
888 020 200306	12 Modül Slim Alüminyum Bürokit Blok (Boş)	50 x 315 x 50	48,40
888 020 200307	14 Modül Slim Alüminyum Bürokit Blok (Boş)	50 x 360 x 50	54,09
888 020 200308	16 Modül Slim Alüminyum Bürokit Blok (Boş)	50 x 405 x 50	59,79
888 020 200309	18 Modül Slim Alüminyum Bürokit Blok (Boş)	50 x 450 x 50	65,48
888 020 200310	20 Modül Slim Alüminyum Bürokit Blok (Boş)	50 x 495 x 50	71,18

Ürün Kodu	Açıklama	Ürün Ölçüsü En x Boy x Yükseklik(mm)	Fiyat
888 020 200401	4 Modül Euro Alüminyum Bürokit Blok (Boş)	60 x 190 x 55	31,32
888 020 200402	6 Modül Euro Alüminyum Bürokit Blok (Boş)	60 x 235 x 55	39,86
888 020 200403	8 Modül Euro Alüminyum Bürokit Blok (Boş)	60 x 280 x 55	42,71
888 020 200404	10 Modül Euro Alüminyum Bürokit Blok (Boş)	60 x 325 x 55	48,40
888 020 200405	12 Modül Euro Alüminyum Bürokit Blok (Boş)	60 x 370 x 55	54,09
888 020 200406	14 Modül Euro Alüminyum Bürokit Blok (Boş)	60 x 415 x 55	59,79
888 020 200407	16 Modül Euro Alüminyum Bürokit Blok (Boş)	60 X 460 X 55	65,48
888 020 200408	18 Modül Euro Alüminyum Bürokit Blok (Boş)	60 X 505 X 55	71,18
888 020 200409	20 Modül Euro Alüminyum Bürokit Blok (Boş)	60 X 550 X 55	76,87



Ürün Kodu	Açıklama	Ürün Ölçüsü En x Boy (mm)	Fiyat
888 020 200501	1 Modül Boşluk Kapama	22,5 x 45	1,71
888 020 200502	2 Modül Boşluk Kapama	45 x 45	2,56
888 020 200503	3 Modül Boşluk Kapama	67,5 x 45	3,27

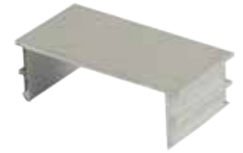

ÜRÜN KODU
075 171 222508
ÜRÜN ADI
14 MOD. DÖŞ. ALTI PRİZ
S.(BOŞ) 221X255
AMBALAJ ADET / KOLİ
1
FİYAT
136,66 TL



ÜRÜN KODU
075 171 333308
ÜRÜN ADI
14 MOD. DÖŞ. ALTI PRİZ
S.BUAT 330X330
AMBALAJ ADET / KOLİ
1
FİYAT
142,87 TL

YENİ
ÜRÜNLERİMİZ

RACK KABİN PRİZ ve AKSESUARLARI



ÜRÜN KODU
888 020 200602

ÜRÜN ADI

19" 1U 6 ADET (SCHUKO SOKETLİ) ANAHTARLI 1,5mt KABLULU
RACK KABİN PRİZ

AMBALAJ ADET / KOLİ

1

FİYAT
20,50 \$

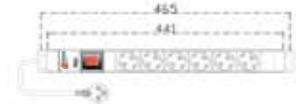

ÜRÜN KODU
888 020 200604

ÜRÜN ADI

19" 1U 6 ADET (SCHUKO SOKETLİ) 16A SİGORTALI 1,5mt KABLULU
RACK KABİN PRİZ

AMBALAJ ADET / KOLİ

1

FİYAT
21,07 \$



ÜRÜN KODU
888 020 200606

ÜRÜN ADI

19" 1U 6 ADET (SCHUKO SOKETLİ) 16A SİGORTALI, AKIM VE GERİLİM
GÖSTERGELİ 1,5mt KABLULU RACK KABİN PRİZ

AMBALAJ ADET / KOLİ

1

FİYAT
39,86 \$



ÜRÜN KODU
888 020 200608

ÜRÜN ADI

19" 1U 8 ADET (SCHUKO SOKETLİ) ANAHTARLI 1,5mt KABLULU
RACK KABİN PRİZ

AMBALAJ ADET / KOLİ

1

FİYAT
22,32 \$

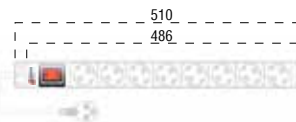

ÜRÜN KODU
888 020 200610

ÜRÜN ADI

19" 2U 12 ADET (SCHUKO SOKETLİ) 16A SİGORTALI 1,5mt KABLULU
RACK KABİN PRİZ

AMBALAJ ADET / KOLİ

1

FİYAT
42,71 \$



ÜRÜN KODU
888 020 200702

ÜRÜN ADI

19" 1U 6 ADET (C13 SOKET) SİGORTALI 1,5mt KABLULU
RACK KABİN PRİZ

AMBALAJ ADET / KOLİ

1

FİYAT
40,60 \$





ÜRÜN KODU 888 020 200611
ÜRÜN ADI 24 PORT PATCH PANEL
AMBALAJ ADET / KOLİ 1
FİYAT 11,39 \$



ÜRÜN KODU 888 020 200612
ÜRÜN ADI 19" 1U METAL KANCALI KABLO SEPERATÖRÜ
AMBALAJ ADET / KOLİ 1
FİYAT 3,84 \$



ÜRÜN KODU 888 020 200613
ÜRÜN ADI 19" 1U KABLO SEPERATÖRÜ
AMBALAJ ADET / KOLİ 1
FİYAT 3,70 \$



KABLO TOPLAMA SİRALI

888 020 900003	R1034 16 MM KAB.TOP SPR.(1,5M VAK)	1 ad.	40	4,25 \$
888 020 900006	R1035 22 MM KAB.TOP SPR.(1,5M VAK)	1 ad.	40	5,78 \$
888 020 900009	R1036 28 MM KAB.TOP SPR.(1,5M VAK)	1 ad.	40	7,35 \$
888 020 900001	R1033 10 MM KAB.TOP SPR. (25M RULO)	1 mt.	50	2,11 \$
888 020 900004	R1034 16 MM KAB.TOP SPR. (25M RULO)	1 mt.	25	2,35 \$
888 020 900007	R1035 22 MM KAB.TOP SPR. (25M RULO)	1 mt.	25	3,28 \$
888 020 900010	R1036 28 MM KAB.TOP SPR. (25M RULO)	1 mt.	25	4,29 \$
888 020 900011	R1037 34 MM KAB.TOP SPR. (25M RULO)	1 mt.	25	5,36 \$

KABLO OMURGA KANALI

888 020 200801	KABLO OMURGA KANALI (BEYAZ)	1 ad.	59,79
888 020 200802	KABLO OMURGA KANALI (GRİ)	1 ad.	54,09
888 020 200803	KABLO OMURGA KANALI (SİYAH)	1 ad.	54,09

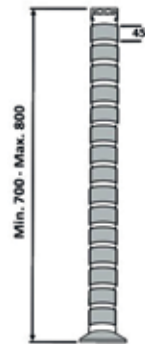

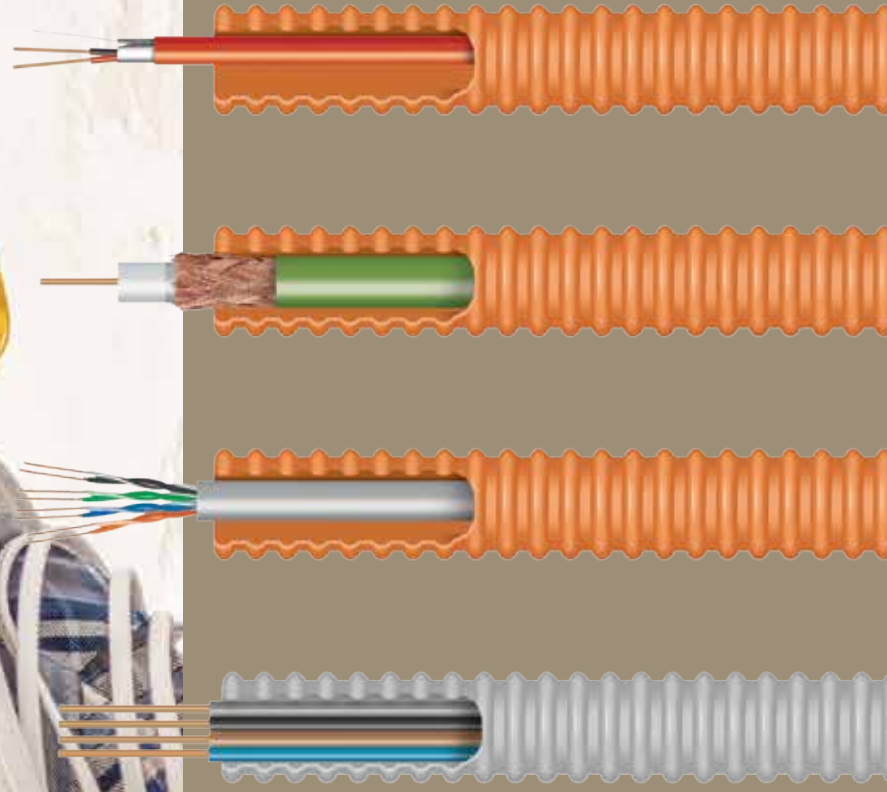

HAZIR
KABLOLU
SPİRALLER

USTANIZIN İŞİ
ARTIK ÇABUK
BİTECEK

SPİRALLİ KABLOLAR

TÜM SPİRALLER HALOGEN FREE ÖZELLİKLERİDİR.
HALOGEN FREE ÖZELLİĞİ KABLOLARDA
DEĞİŞMEKTEDİR.

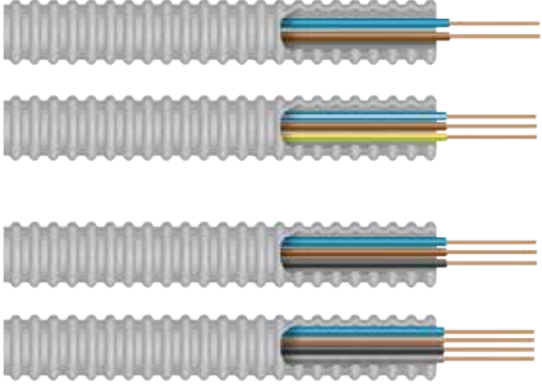

SPİRALLİ ENERJİ KABLOLARI HALOGEN FREE



Kod	Kablo Kesit mm ²	Spiral Özellik	Spiral Çap (mm)
H07Z1-U (NYA) KABLOLAR HALOGEN FREE			
122 051 215014	2x1.5	HF-PE	16
122 051 315014	3x1.5	HF-PE	16
122 051 415016	4x1.5	HF-PE	16
122 051 515020	5x1.5	HF-PE	20
122 051 225014	2x2.5	HF-PE	16
122 051 325014	3x2.5	HF-PE	16
122 051 425016	4x2.5	HF-PE	16
122 051 525025	5x2.5	HF-PE	25



SPİRALLİ ZAYIF AKIM KABLOLARI HALOGEN FREE



Kod	Kablo Kesit mm ²	Spiral Özellik	Spiral Çap (mm)
(LSZH) DATA KABLOLARI HALOGEN FREE			
122 053 100516	U/UTP CAT5e (4x2x24AWG)	HF-PE	14
122 053 100616	U/UTP CAT6 (4x2x23AWG)	HF-PE	14
(PHY - HF) KOAKSİYEL KABLOLAR HALOGEN FREE			
122 053 200416	RG 6 U/4 (Cu/AL)	HF-PE	14
122 053 200616	RG 6 U/6 (Cu/Cu)	HF-PE	14
CCTV KAMERA KABLOLARI HALOGEN FREE			
122 053 301214	1+2 RG 59 Mini (2x0.50 mm ²)	HF-PE	14
122 053 301416	1+4 RG 59 Mini (2x0.50 mm ²) + (2x0.22 mm ²)	HF-PE	14
J-H (st) H YANGIN İHBAR KABLOSU HALOGEN FREE			
122 053 401216	1x2x0.80 mm ² + 0.80 mm ²	HF-PE	14
122 053 402216	2x2x0.80 mm ² + 0.80 mm ²	HF-PE	14
LIHH DİYAFON KABLOLARI HALOGEN FREE			
122 053 502216	LIHH 8x0.22 mm ²	HF-PE	14

*Güncel fiyatlar için satış temsilciniz ile irtibata geçiniz.

SPİRALLİ KABLOLAR

TÜM SPİRALLER HALOGEN FREE ÖZELLİKLİDİR.
HALOGEN FREE ÖZELLİĞİ KABLOLARDA
DEĞİŞMEKTEDİR.

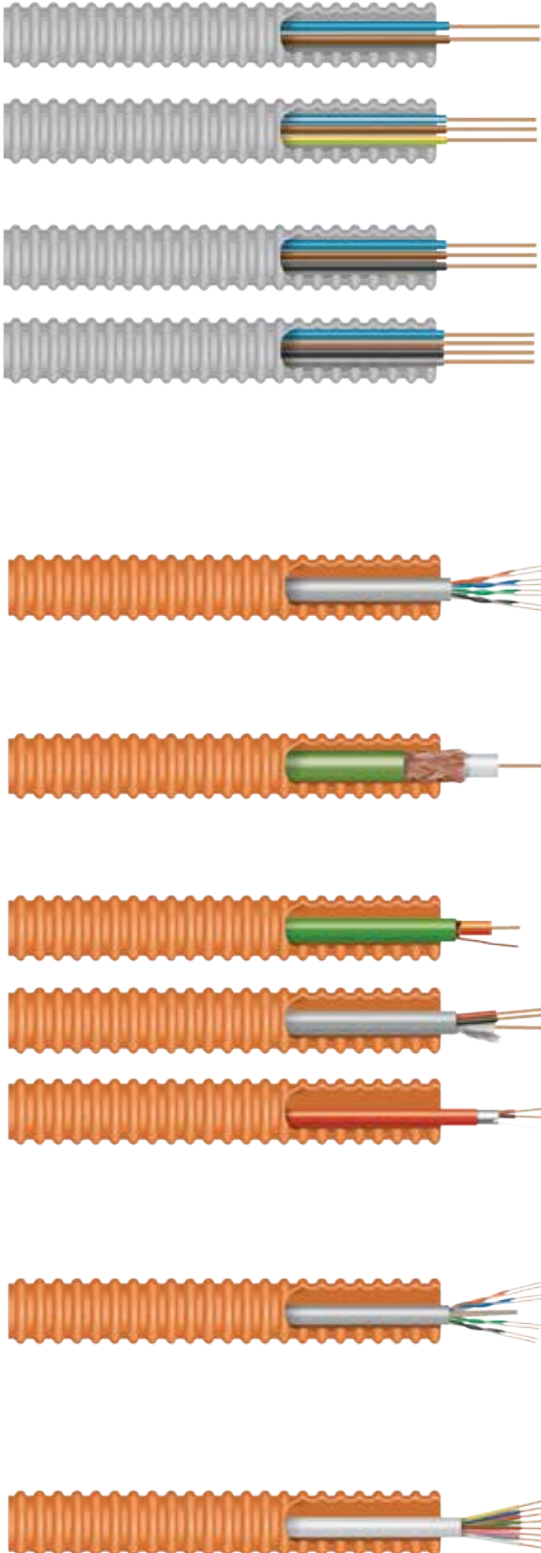

SPİRALLİ ENERJİ KABLOLARI

Kod	Kablo Kesit mm ²	Spiral Özellik	Spiral Çap (mm)
H07V-U (NYA) KABLOLAR			
122 050 215014	2x1.5	HF-PE	16
122 050 315014	3x1.5	HF-PE	16
122 050 415016	4x1.5	HF-PE	16
122 050 515020	5x1.5	HF-PE	20
122 050 225014	2x2.5	HF-PE	16
122 050 325014	3x2.5	HF-PE	16
122 050 425016	4x2.5	HF-PE	16
122 050 525025	5x2.5	HF-PE	25

SPİRALLİ ZAYIF AKIM KABLOLARI

Kod	Kablo Kesit mm ²	Spiral Özellik	Spiral Çap (mm)
DATA KABLOLARI			
122 052 100516	U / UTP CAT5e	HF-PE	14
122 052 100616	U / UTP CAT6e	HF-PE	14
KOAKSİYEL KABLOLAR			
122 052 200214	RG 59/U2(cu/AL)	HF-PE	14
122 052 200416	RG 6/U4 (cu/AL)	HF-PE	14
122 052 200616	RG 6/U6 (cu/cu)	HF-PE	14
CCTV KAMERA KABLOLARI			
122 052 301214	CCTV 1+2 (2x0.22 mm ²)	HF-PE	14
122 052 301416	CCTV 1+4 (2x2x0.22 mm ²)	HF-PE	14
JY (st) Y YANGIN İHBAR KABLOLARI			
122 052 401215	JY(st)Y 1x2x0.80+40 mm ²	HF-PE	14
122 052 402216	JY(st)Y 2x2x0.80+40 mm ²	HF-PE	14
DİYAFON KABLOLARI			
122 052 502216	DT-8 8x0.22 mm ²	HF-PE	14

*Güncel fiyatlar için satış temsilciniz ile irtibata geçiniz.

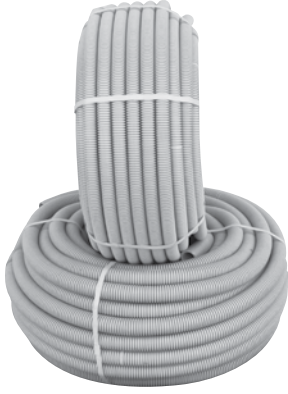

Kod	Açıklama / Stok Cinsi	Ort. İç Çap	Ort. Dış Çap	Amb. (Kutu)	Amb. Birimi	FİYAT
HAFİF SERİ PVC. SİRALLER (A.YAYMAYAN) (320N)						
001 020 010016 00 17	16 Ø A.YAYMAYAN SİRAL (HAFİF SERİ)	11,4	15,85	100 mt.	500	1,10
001 020 010020 00 17	20 Ø A.YAYMAYAN SİRAL (HAFİF SERİ)	14,5	19,85	100 mt.	500	1,67
001 020 010025 00 17	25 Ø A.YAYMAYAN SİRAL (HAFİF SERİ)	18,7	24,8	50 mt.	250	2,34
001 020 010032 00 17	32 Ø A.YAYMAYAN SİRAL (HAFİF SERİ)	24,9	31,8	50 mt.	250	3,00
AĞIR SERİ PVC. SİRALLER (A.YAYMAYAN) (750N)						
001 020 000016 00 17	16 Ø A.YAYMAYAN SİRAL (AĞIR SERİ)	11,2	15,85	100 mt.	500	1,20
001 020 000020 00 17	20 Ø A.YAYMAYAN SİRAL (AĞIR SERİ)	14,4	19,85	100 mt.	500	1,84
001 020 000025 00 17	25 Ø A.YAYMAYAN SİRAL (AĞIR SERİ)	18,1	24,8	50 mt.	250	2,50
001 020 000032 00 17	32 Ø A.YAYMAYAN SİRAL (AĞIR SERİ)	24,7	31,8	50 mt.	250	3,27
HAFİF SERİ PVC. TELLİ SİRALLER (A.YAYMAYAN) (320N)						
001 020 120016 00 17	16 Ø TELLİ A.YAYMAYAN (HAFİF SERİ)	11,4	15,85	100 mt.	500	1,44
001 020 120020 00 17	20 Ø TELLİ A.YAYMAYAN (HAFİF SERİ)	14,5	19,85	100 mt.	500	1,90
001 020 120025 00 17	25 Ø TELLİ A.YAYMAYAN (HAFİF SERİ)	18,7	24,8	50 mt.	250	2,57
001 020 120032 00 17	32 Ø TELLİ A.YAYMAYAN (HAFİF SERİ)	24,9	31,8	50 mt.	250	3,41
AĞIR SERİ PVC. TELLİ SİRALLER (A.YAYMAYAN) (750N)						
001 020 100016 00 17	16 Ø TELLİ A.YAYMAYAN (AĞIR SERİ)	11,2	15,85	100 mt.	500	1,49
001 020 100020 00 17	20 Ø TELLİ A.YAYMAYAN (AĞIR SERİ)	14,4	19,85	100 mt.	500	2,11
001 020 100025 00 17	25 Ø TELLİ A.YAYMAYAN (AĞIR SERİ)	18,1	24,8	50 mt.	250	2,77
001 020 100032 00 17	32 Ø TELLİ A.YAYMAYAN (AĞIR SERİ)	24,7	31,8	50 mt.	250	3,61
HALOJEN FREE SİRALLER (A.YAYAN) (320N)						
001 020 140016 00 17	16 Ø HALOJEN FREE SPR. (ALEV YAYAN)	11,2	15,7	100 mt.	500	0,67
001 020 140020 00 17	20 Ø HALOJEN FREE SPR. (ALEV YAYAN)	14,4	19,85	100 mt.	500	0,90
001 020 140025 00 17	25 Ø HALOJEN FREE SPR. (ALEV YAYAN)	19,1	24,7	50 mt.	250	1,28
001 020 140032 00 17	32 Ø HALOJEN FREE SPR. (ALEV YAYAN)	24,85	31,6	50 mt.	250	1,54
001 020 140040 00 17	40 Ø HALOJEN FREE SPR. (ALEV YAYAN)			25 mt.	125	2,57
001 020 140050 00 17	50 Ø HALOJEN FREE SPR. (ALEV YAYAN)			25 mt.	125	3,23
HALOJEN FREE SİRALLER (A.YAYAN) (750N)						
001 020 740020 00 17	20 Ø HALOJEN FREE SPR. (ALEV YAYAN)	14,4	19,85	100 mt.	500	1,90
001 020 740025 00 17	25 Ø HALOJEN FREE SPR. (ALEV YAYAN)	18,7	24,7	50 mt.	250	2,54
001 020 740032 00 17	32 Ø HALOJEN FREE SPR. (ALEV YAYAN)	24,2	31,6	50 mt.	250	3,44
HALOJEN FREE SİRALLER (A.YAYAN) (1250N)						
001 020 240020 00 17	20 Ø HALOJEN FREE SPR. (ALEV YAYAN)	14	19,85	100 mt.	500	2,54
001 020 240025 00 17	25 Ø HALOJEN FREE SPR. (ALEV YAYAN)	18,4	24,7	50 mt.	250	3,62
001 020 240032 00 17	32 Ø HALOJEN FREE SPR. (ALEV YAYAN)	24	31,6	50 mt.	250	4,60
HALOJEN FREE SİRALLER TELLİ (A.YAYAN) (320N)						
001 020 141016 00 17	16 Ø H.FREE SİRAL(A.YAYAN)(TELLİ)	11,2	15,7	100 mt.	500	0,87
001 020 141020 00 17	20 Ø H.FREE SİRAL(A.YAYAN)(TELLİ)	14,4	19,85	100 mt.	500	1,10
001 020 141025 00 17	25 Ø H.FREE SİRAL(A.YAYAN)(TELLİ)	19,1	24,7	50 mt.	250	1,49
001 020 141032 00 17	32 Ø H.FREE SİRAL(A.YAYAN)(TELLİ)	24,85	31,6	50 mt.	250	1,75
001 020 141040 00 17	40 Ø H.FREE SİRAL(A.YAYAN)(TELLİ)			25 mt.	125	2,77
HALOJEN FREE SİRALLER (A.YAYMAYAN) (320N)						
001 020 150016 00 17	16 Ø HALOJEN FREE SPR.(A.YAYMAYAN)	11,2	15,7	100 mt.	500	1,07
001 020 150020 00 17	20 Ø HALOJEN FREE SPR.(A.YAYMAYAN)	14,4	19,85	100 mt.	500	1,44
001 020 150025 00 17	25 Ø HALOJEN FREE SPR.(A.YAYMAYAN)	19,1	24,7	50 mt.	250	2,05
001 020 150032 00 17	32 Ø HALOJEN FREE SPR.(A.YAYMAYAN)	24,85	31,6	50 mt.	250	2,46
001 020 150040 00 17	40 Ø HALOJEN FREE SPR.(A.YAYMAYAN)			25 mt.	125	4,11
001 020 150050 00 17	50 Ø HALOJEN FREE SPR.(A.YAYMAYAN)			25 mt.	125	5,18
HALOJEN FREE SİRALLER (A.YAYMAYAN) (750N)						
001 020 750020 00 17	20 Ø HALOJEN FREE SPR. (ALEV YAYMAYAN)	14,4	19,85	100 mt.	500	2,98
001 020 750025 00 17	25 Ø HALOJEN FREE SPR. (ALEV YAYMAYAN)	18,7	24,7	50 mt.	250	4,00
001 020 750032 00 17	32 Ø HALOJEN FREE SPR. (ALEV YAYMAYAN)	24,2	31,6	50 mt.	250	5,44
HALOJEN FREE SİRALLER (A.YAYMAYAN) (1250N)						
001 020 250020 00 17	20 Ø HALOJEN FREE SPR. (ALEV YAYMAYAN)	14	19,85	100 mt.	500	4,00
001 020 250025 00 17	25 Ø HALOJEN FREE SPR. (ALEV YAYMAYAN)	18,4	24,7	50 mt.	250	5,73
001 020 250032 00 17	32 Ø HALOJEN FREE SPR. (ALEV YAYMAYAN)	24	31,6	50 mt.	250	7,29
HALOJEN FREE SİRALLER TELLİ (A.YAYMAYAN) (320N)						
001 020 151016 00 17	16 Ø H.FREE SPR.(A.YAYMAYAN)(TELLİ)	11,2	15,7	100 mt.	500	1,33
001 020 151020 00 17	20 Ø H.FREE SPR.(A.YAYMAYAN)(TELLİ)	14,4	19,85	100 mt.	500	1,70
001 020 151025 00 17	25 Ø H.FREE SPR.(A.YAYMAYAN)(TELLİ)	19,1	24,7	50 mt.	250	2,32
001 020 151032 00 17	32 Ø H.FREE SPR.(A.YAYMAYAN)(TELLİ)	24,85	31,6	50 mt.	250	2,73
001 020 151040 00 17	40 Ø H.FREE SPR.(A.YAYMAYAN)(TELLİ)			25 mt.	125	4,37

Kod	Açıklama / Stok Cinsi	Amb. (Kutu)	Amb. Birimi	FIYAT
MEKS SERİSİ PLASTİK SİRALLER (SİYAH)				
	Ort. İç Çap	Ort. Dış Çap		
001 020 400014 00 11	14 Ø PLASTİK SİRALLER (SİYAH)	15,25	18,75	100 mt. 1000 0,54
001 020 400016 00 11	16 Ø PLASTİK SİRALLER (SİYAH)	15,7	19	100 mt. 1000 0,54
001 020 400018 00 11	18 Ø PLASTİK SİRALLER (SİYAH)	19,6	24,03	50 mt. 500 1,01
001 020 400020 00 11	20 Ø PLASTİK SİRALLER (SİYAH)	19,6	24,03	50 mt. 500 1,01
001 020 400026 00 11	26 Ø PLASTİK SİRALLER (SİYAH)	26,15	30,75	50 mt. 250 1,09
001 020 400032 00 11	32 Ø PLASTİK SİRALLER (SİYAH)	29,1	34,3	50 mt. 250 1,31
001 020 400040 00 11	40 Ø PLASTİK SİRALLER (SİYAH)	36,2	42,2	25 mt. 125 1,92
001 020 400050 00 11	50 Ø PLASTİK SİRALLER (SİYAH)	48,5	54,5	25 mt. 125 2,37

PLASTİK SİRALLER (SİYAH) (TELLİ)

Kod	Açıklama / Stok Cinsi	Ort. İç Çap	Ort. Dış Çap	Amb. (Kutu)	Amb. Birimi	FIYAT
001 020 410014 00 11	14 Ø PLASTİK SİRALLER (SİYAH) TELLİ	15,25	18,75	100 mt.	1000	0,70
001 020 410016 00 11	16 Ø PLASTİK SİRALLER (SİYAH) TELLİ	15,7	19	100 mt.	1000	0,70
001 020 410018 00 11	18 Ø PLASTİK SİRALLER (SİYAH) TELLİ	19,6	24,03	50 mt.	500	1,12
001 020 410020 00 11	20 Ø PLASTİK SİRALLER (SİYAH) TELLİ	19,6	24,03	50 mt.	500	1,12
001 020 410026 00 11	26 Ø PLASTİK SİRALLER (SİYAH) TELLİ	26,15	30,75	50 mt.	250	1,22
001 020 410032 00 11	32 Ø PLASTİK SİRALLER (SİYAH) TELLİ	29,1	34,3	50 mt.	250	1,48
001 020 410040 00 11	40 Ø PLASTİK SİRALLER (SİYAH) TELLİ	36,2	42,2	25 mt.	125	2,09

PLASTİK SİRALLER (RENKLİ)

Kod	Açıklama / Stok Cinsi	Ort. İç Çap	Ort. Dış Çap	Amb. (Kutu)	Amb. Birimi	FIYAT
001 020 400014 00 XX	14 Ø PLS. SİRAL (GRİ-BYZ-KIR-MAVİ)	15,25	18,75	100 mt.	1000	0,77
001 020 400016 00 XX	16 Ø PLS. SİRAL (GRİ-BYZ-KIR-MAVİ)	15,7	19	100 mt.	1000	0,77
001 020 400018 00 XX	18 Ø PLS. SİRAL (GRİ-BYZ-KIR-MAVİ)	19,6	24,03	50 mt.	500	1,28
001 020 400020 00 XX	20 Ø PLS. SİRAL (GRİ-BYZ-KIR-MAVİ)	19,6	24,03	50 mt.	250	1,28
001 020 400026 00 XX	26 Ø PLS. SİRAL (GRİ-BYZ-KIR-MAVİ)	26,15	30,75	50 mt.	250	1,54
001 020 400032 00 XX	32 Ø PLS. SİRAL (GRİ-BYZ-KIR-MAVİ)	29,1	34,3	50 mt.	250	1,93
001 020 400040 00 XX	40 Ø PLS. SİRAL (GRİ-BYZ-KIR-MAVİ)	36,2	42,2	25 mt.	125	2,82
001 020 400050 00 XX	50 Ø PLS. SİRAL (GRİ-BYZ-KIR-MAVİ)	48,5	54,5	25 mt.	125	3,49
001 020 990016 00 17	16MM SİRAL EK MUFU (GRİ)				200 ad.	0,91
001 020 990020 00 17	20MM SİRAL EK MUFU (GRİ)				200 ad.	0,91
001 020 990025 00 17	25MM SİRAL EK MUFU (GRİ)				100 ad.	1,36
001 020 990032 00 17	32MM SİRAL EK MUFU (GRİ)				200 ad.	1,48

KORUGE BORULAR (250N)

Kod	Açıklama / Stok Cinsi	Amb. (Kutu)	Amb. Birimi	FIYAT
096 045 150050	50 Ø KORUGE KANGAL BORU	100	mt.	4,17
096 045 150060	63 Ø KORUGE KANGAL BORU	100	mt.	4,97
096 045 150075	75 Ø KORUGE KANGAL BORU	100	mt.	6,05
096 045 150100	100 Ø KORUGE BOY BORU (6 MT.)	6	mt.	7,39
096 045 150115	115 Ø KORUGE BOY BORU (6 MT.)	6	mt.	7,93
096 045 150004	50 Ø MANŞON	1	ad.	2,42
096 045 150003	75 Ø MANŞON	1	ad.	2,70
096 045 150002	100 Ø MANŞON	1	ad.	3,09
096 045 150001	115 Ø MANŞON	1	ad.	3,36

KORUGE BORULAR

Kod	Açıklama / Stok Cinsi	Amb. (Kutu)	Amb. Birimi	FIYAT
096 045 160050	50 Ø KORUGE KANGAL BORU+MANŞON	6	mt.	4,17
096 045 160075	75 Ø KORUGE KANGAL BORU+MANŞON	6	mt.	4,84
096 045 150110	110 Ø KORUGE KANGAL BORU+MANŞON	6	mt.	7,26

LOGAR KUTUSU

Kod	Açıklama / Stok Cinsi	Amb. (Kutu)	Amb. Birimi	FIYAT
074 048 622020	20X20 LOGAR KUTUSU TAKIM	1 ad.		21,51
074 048 623030	30X30 LOGAR KUTUSU TAKIM	1 ad.		45,71
074 048 624040	40X40 LOGAR KUTUSU TAKIM	1 ad.		86,04
074 048 625050	50X50 LOGAR KUTUSU TAKIM	1 ad.		198,98
074 048 625555	55X55 LOGAR KUTUSU TAKIM	1 ad.		255,44



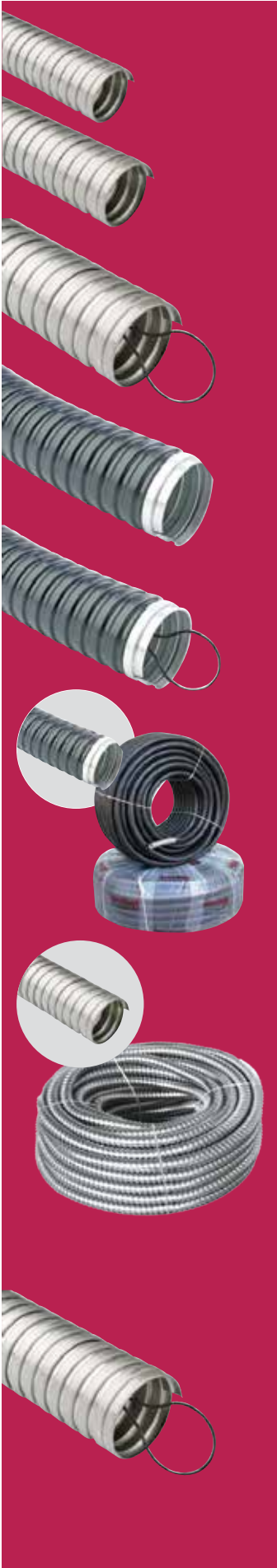

Kod	Açıklama / Stok Cinsi	Ort. İç Çap	Ort. Dış Çap	Amb. (Kutu)	Amb. Birimi	FİYAT
EKO SERİSİ ÇELİK SİRALLER						
		Ort. İç Çap	Ort. Dış Çap	CE		
001 054 150009 00 66	9 Ø EKO ÇELİK SİRALLER	9	12,1	50 mt.	200	1,76
001 054 150011 00 66	11 Ø EKO ÇELİK SİRALLER (3/8")	11	14,1	50 mt.	200	2,00
001 054 150014 00 66	14 Ø EKO ÇELİK SİRALLER (1/2")	14	17,1	50 mt.	200	2,42
001 054 150016 00 66	16 Ø EKO ÇELİK SİRALLER	16	19,1	50 mt.	200	2,69
001 054 150018 00 66	18 Ø EKO ÇELİK SİRALLER (3/4")	18	21,1	50 mt.	200	3,01
001 054 150021 00 66	21 Ø EKO ÇELİK SİRALLER	21	24,1	50 mt.	200	3,52
001 054 150026 00 66	26 Ø EKO ÇELİK SİRALLER (1")	26	29,1	25 mt.	100	4,52
001 054 150029 00 66	29 Ø EKO ÇELİK SİRALLER (1 1/4")	29	32,1	25 mt.	100	4,90
001 054 150032 00 66	32 Ø EKO ÇELİK SİRALLER	32	35,1	25 mt.	100	5,47
001 054 150037 00 66	37 Ø EKO ÇELİK SİRALLER (1 1/2")	37	41,1	25 mt.	100	6,71
001 054 150042 00 66	42 Ø EKO ÇELİK SİRALLER	42	45,1	25 mt.	100	8,18
001 054 150050 00 66	50 Ø EKO ÇELİK SİRALLER (2")	50	53,1	25 mt.	100	10,43
EKO SERİSİ ÇELİK SİRALLER (KLAUZ TELLİ)						
		Ort. İç Çap	Ort. Dış Çap	CE		
001 054 221011 00 66	11 Ø EKO Ç. SİRAL(TELLİ)(3/8")	11	14,1	50 mt.	200	2,17
001 054 221014 00 66	14 Ø EKO Ç. SİRAL(TELLİ)(1/2")	14	17,1	50 mt.	200	2,61
001 054 221016 00 66	16 Ø EKO Ç. SİRAL(TELLİ)	16	19,1	50 mt.	200	3,05
001 054 221018 00 66	18 Ø EKO Ç. SİRAL(TELLİ) (3/4")	18	21,1	50 mt.	200	3,27
001 054 221021 00 66	21 Ø EKO Ç. SİRAL(TELLİ)	21	24,1	50 mt.	200	3,79
001 054 221026 00 66	26 Ø EKO Ç. SİRAL(TELLİ)(1")	26	29,1	25 mt.	100	4,80
001 054 221029 00 66	29 Ø EKO Ç. SİRAL(TELLİ)(1 1/4")	29	32,1	25 mt.	100	5,03
001 054 221032 00 66	32 Ø EKO Ç. SİRAL(TELLİ)	32	35,1	25 mt.	100	5,69
001 054 221037 00 66	37 Ø EKO Ç. SİRAL(TELLİ)(1 1/2")	37	41,1	25 mt.	100	6,98
001 054 221042 00 66	42 Ø EKO Ç. SİRAL(TELLİ)	42	45,1	25 mt.	100	10,13
001 054 221050 00 66	50 Ø EKO Ç. SİRAL(TELLİ) (2")	50	53,1	25 mt.	100	10,76
EKO SERİSİ İZOLELİ ÇELİK SİRALLER						
		Ort. İç Çap	Ort. Dış Çap	CE		
001 054 160009 00 11	9 Ø EKO İZOLELİ Ç. SİRAL	9	13,2	50 mt.		2,40
001 054 160011 00 11	11 Ø EKO İZOLELİ Ç. SİRAL(3/8")	11	15,2	50 mt.		2,67
001 054 160014 00 11	14 Ø EKO İZOLELİ Ç. SİRAL(1/2")	14	18,4	50 mt.		3,17
001 054 160016 00 11	16 Ø EKO İZOLELİ Ç. SİRAL	16	20,4	50 mt.		3,47
001 054 160018 00 11	18 Ø EKO İZOLELİ Ç. SİRAL(3/4")	18	22,4	50 mt.		4,00
001 054 160021 00 11	21 Ø EKO İZOLELİ Ç. SİRAL	21	25,4	50 mt.		5,06
001 054 160026 00 11	26 Ø EKO İZOLELİ Ç. SİRAL(1")	26	30,4	25 mt.		5,60
001 054 160029 00 11	29 Ø EKO İZOLELİ Ç. SİRAL(1 1/4")	29	33,4	25 mt.		6,44
001 054 160032 00 11	32 Ø EKO İZOLELİ Ç. SİRAL	32	36,4	25 mt.		7,64
001 054 160037 00 11	37 Ø EKO İZOLELİ Ç. SİRAL (1 1/2")	37	42,4	25 mt.		8,31
001 054 160042 00 11	42 Ø EKO İZOLELİ Ç. SİRAL	42	46,4	25 mt.		9,91
001 054 160050 00 11	50 Ø EKO İZOLELİ Ç. SİRAL(2")	50	54,4	25 mt.		13,32
EKO SERİSİ İZOLELİ ÇELİK SİRALLER (KLAUZ TELLİ)						
		Ort. İç Çap	Ort. Dış Çap	CE		
001 054 231011 00 11	11 Ø EKO İZO.Ç. SPR.(TELLİ)(3/8")	11	15,2	50 mt.		2,91
001 054 231014 00 11	14 Ø EKO İZO.Ç. SPR.(TELLİ)(1/2")	14	18,4	50 mt.		3,43
001 054 231016 00 11	16 Ø EKO İZO.Ç. SPR.(TELLİ)	16	20,4	50 mt.		3,68
001 054 231018 00 11	18 Ø EKO İZO.Ç. SPR.(TELLİ) (3/4")	18	22,4	50 mt.		4,26
001 054 231021 00 11	21 Ø EKO İZO.Ç. SPR.(TELLİ)	21	25,4	50 mt.		5,22
001 054 231026 00 11	26 Ø EKO İZO.Ç. SPR.(TELLİ)(1")	26	30,4	25 mt.		5,84
001 054 231029 00 11	29 Ø EKO İZO.Ç. SPR.(TELLİ)(1 1/4")	29	33,4	25 mt.		6,63
001 054 231032 00 11	32 Ø EKO İZO.Ç. SPR.(TELLİ)	32	36,4	25 mt.		7,84
001 054 231037 00 11	37 Ø EKO İZO.Ç. SPR.(TELLİ)(1 1/2")	37	42,4	25 mt.		8,55
001 054 231042 00 11	42 Ø EKO İZO.Ç. SPR.(TELLİ)	42	46,4	25 mt.		10,69
001 054 231050 00 11	50 Ø EKO İZO.Ç. SPR.(TELLİ) (2")	50	54,4	25 mt.		14,34
MEKS SERİSİ ÇELİK SİRALLER						
		Ort. İç Çap	Ort. Dış Çap			
001 054 120009 00 66	9 Ø ÇELİK SİRALLER	9	12,1	50 mt.	200	2,07
001 054 120011 00 66	11 Ø ÇELİK SİRALLER (3/8")	11	14,1	50 mt.	200	2,19
001 054 120014 00 66	14 Ø ÇELİK SİRALLER (1/2")	14	17,1	50 mt.	200	2,63
001 054 120016 00 66	16 Ø ÇELİK SİRALLER	16	19,1	50 mt.	200	3,02
001 054 120018 00 66	18 Ø ÇELİK SİRALLER (3/4")	18	21,1	50 mt.	200	3,30
001 054 120021 00 66	21 Ø ÇELİK SİRALLER	21	24,1	50 mt.	200	3,77
001 054 120026 00 66	26 Ø ÇELİK SİRALLER (1")	26	29,1	25 mt.	100	4,77
001 054 120029 00 66	29 Ø ÇELİK SİRALLER (1 1/4")	29	32,1	25 mt.	100	5,03
001 054 120032 00 66	32 Ø ÇELİK SİRALLER	32	35,1	25 mt.	100	6,21
001 054 120037 00 66	37 Ø ÇELİK SİRALLER (1 1/2")	37	41,1	25 mt.	100	7,40
001 054 120042 00 66	42 Ø ÇELİK SİRALLER	42	45,1	25 mt.	100	9,02
001 054 120050 00 66	50 Ø ÇELİK SİRALLER (2")	50	53,1	25 mt.	100	11,48
001 054 120063 00 66	63 Ø ÇELİK SİRALLER	63	66,1	15 mt.	60	15,30
MEKS SERİSİ ÇELİK SİRALLER (KLAUZ TELLİ)						
		Ort. İç Çap	Ort. Dış Çap			
001 054 121011 00 66	11 Ø Ç. SİRAL(TELLİ)(3/8")	11	14,1	50 mt.	200	2,54
001 054 121014 00 66	14 Ø Ç. SİRAL(TELLİ)(1/2")	14	17,1	50 mt.	200	2,93
001 054 121016 00 66	16 Ø Ç. SİRAL(TELLİ)	16	19,1	50 mt.	200	3,28
001 054 121018 00 66	18 Ø Ç. SİRAL(TELLİ) (3/4")	18	21,1	50 mt.	200	3,62
001 054 121021 00 66	21 Ø Ç. SİRAL(TELLİ)	21	24,1	50 mt.	200	4,30
001 054 121026 00 66	26 Ø Ç. SİRAL(TELLİ)(1")	26	29,1	25 mt.	100	4,74
001 054 121029 00 66	29 Ø Ç. SİRAL(TELLİ)(1 1/4")	29	32,1	25 mt.	100	5,39
001 054 121032 00 66	32 Ø Ç. SİRAL(TELLİ)	32	35,1	25 mt.	100	6,45
001 054 121037 00 66	37 Ø Ç. SİRAL(TELLİ)(1 1/2")	37	41,1	25 mt.	100	8,02
001 054 121042 00 66	42 Ø Ç. SİRAL(TELLİ)	42	45,1	25 mt.	100	9,08
001 054 121050 00 66	50 Ø Ç. SİRAL(TELLİ) (2")	50	53,1	25 mt.	100	11,79
001 054 121063 00 66	63 Ø Ç. SİRAL(TELLİ)	63	66,1	15 mt.	60	16,29

Kod	Açıklama / Stok Cinsi	Amb. (Kutu)	Amb. Birimi	FIYAT
MEKS SERİSİ İZOLELİ ÇELİK SİRALER				
		Ort. İç Çap	Ort. Dış Çap	
001 054 130009 00 11	9 Ø İZOLELİ Ç. SİRAL	9	13,2	50 mt. 2,64
001 054 130011 00 11	11 Ø İZOLELİ Ç. SİRAL(3/8")	11	15,2	50 mt. 2,95
001 054 130014 00 11	14 Ø İZOLELİ Ç. SİRAL(1/2")	14	18,4	50 mt. 3,28
001 054 130016 00 11	16 Ø İZOLELİ Ç. SİRAL	16	20,4	50 mt. 3,73
001 054 130018 00 11	18 Ø İZOLELİ Ç. SİRAL(3/4")	18	22,4	50 mt. 4,23
001 054 130026 00 11	26 Ø İZOLELİ Ç. SİRAL(1")	26	30,4	25 mt. 6,09
001 054 130029 00 11	29 Ø İZOLELİ Ç. SİRAL(1 1/4")	29	33,4	25 mt. 6,45
001 054 130032 00 11	32 Ø İZOLELİ Ç. SİRAL	32	36,4	25 mt. 8,17
001 054 130037 00 11	37 Ø İZOLELİ Ç. SİRAL (1 1/2")	37	42,4	25 mt. 8,78
001 054 130042 00 11	42 Ø İZOLELİ Ç. SİRAL	42	46,4	25 mt. 10,44
001 054 130050 00 11	50 Ø İZOLELİ Ç. SİRAL(2")	50	54,4	25 mt. 14,41
001 054 130063 00 11	63 Ø İZOLELİ ÇELİK SİRAL	63	67,2	15 mt. 20,20

MEKS SERİSİ İZOLELİ ÇELİK SİRALER (KLAUZ TELLİ)				
		Ort. İç Çap	Ort. Dış Çap	
001 054 140011 00 11	11 Ø İZO.Ç. SPR.(TELLİ)(3/8")	11	15,2	50 mt. 2,82
001 054 140014 00 11	14 Ø İZO.Ç. SPR.(TELLİ)(1/2")	14	18,4	50 mt. 3,52
001 054 140016 00 11	16 Ø İZO.Ç. SPR. (TELLİ)	16	20,4	50 mt. 3,77
001 054 140018 00 11	18 Ø İZO.Ç. SPR.(TELLİ) (3/4")	18	22,4	50 mt. 4,84
001 054 140026 00 11	26 Ø İZO.Ç. SPR.(TELLİ)(1")	26	30,4	25 mt. 6,65
001 054 140029 00 11	29 Ø İZO.Ç. SPR.(TELLİ)(1 1/4")	29	33,4	25 mt. 7,27
001 054 140032 00 11	32 Ø İZO.Ç. SPR.(TELLİ)	32	36,4	25 mt. 9,07
001 054 140037 00 11	37 Ø İZO.Ç. SPR.(TELLİ)(1 1/2")	37	42,4	25 mt. 9,45
001 054 140042 00 11	42 Ø İZO.Ç. SPR.(TELLİ)	42	46,4	25 mt. 10,93
001 054 140050 00 11	50 Ø İZO.Ç. SPR.(TELLİ) (2")	50	54,4	25 mt. 14,51
001 054 140063 00 11	63 Ø İZO.Ç. SPR.(TELLİ)	63	67,2	15 mt. 20,30

NİKEL KAPLI ÇELİK SİRAL RAKORU				
012 097 030009	CLK- 9 ÇELİK SİRAL RAKORU	150 ad.		10,42
012 097 030011	CLK-11 ÇELİK SİRAL RAKORU	175 ad.		13,69
012 097 030014	CLK-13,5 ÇELİK SİRAL RAKORU	90 ad.		14,88
012 097 030016	CLK-16 ÇELİK SİRAL RAKORU	75 ad.		18,16
012 097 030018	CLK-18 ÇELİK SİRAL RAKORU	80 ad.		21,28
012 097 030026	CLK-26 ÇELİK SİRAL RAKORU	30 ad.		30,06

SÜPER ETANJ METAL RAKORLAR				
057 097 100007	PG-7 METAL RAKOR	1 ad.		1,49 €
057 097 100009	PG-9 METAL RAKOR	1 ad.		1,56 €
057 097 100011	PG-11 METAL RAKOR	1 ad.		1,96 €
057 097 100135	PG-13,5 METAL RAKOR	1 ad.		2,12 €
057 097 100016	PG-16 METAL RAKOR	1 ad.		2,49 €
057 097 100021	PG-21 METAL RAKOR	1 ad.		3,83 €
057 097 100029	PG-29 METAL RAKOR	1 ad.		7,56 €
057 097 100036	PG-36 METAL RAKOR	1 ad.		14,00 €
057 097 100042	PG-42 METAL RAKOR	1 ad.		20,54 €
057 097 100048	PG-48 METAL RAKOR	1 ad.		26,76 €

PİRİNÇ RAKORLAR (NORMAL)				
012 097 010009	9 Ø PİRİNÇ RAKOR (NORMAL)	1 ad.		9,38
012 097 010011	11 Ø PİRİNÇ RAKOR (NORMAL)	1 ad.		10,72
012 097 010135	13.5 Ø PİRİNÇ RAKOR (NORMAL)	1 ad.		13,39
012 097 010016	16 Ø PİRİNÇ RAKOR (NORMAL)	1 ad.		16,07
012 097 010021	21 Ø PİRİNÇ RAKOR (NORMAL)	1 ad.		24,11
012 097 010029	29 Ø PİRİNÇ RAKOR (NORMAL)	1 ad.		37,50
012 097 010036	36 Ø PİRİNÇ RAKOR (NORMAL)	1 ad.		53,58
012 097 010042	42 Ø PİRİNÇ RAKOR (NORMAL)	1 ad.		66,97

PİRİNÇ RAKORLAR (KELEPÇELİ)				
012 097 020009	9 Ø PİRİNÇ RAKOR (KELEPÇELİ)	1 ad.		16,07
012 097 020011	11 Ø PİRİNÇ RAKOR (KELEPÇELİ)	1 ad.		18,75
012 097 020135	13.5 Ø PİRİNÇ RAKOR (KELEPÇELİ)	1 ad.		21,43
012 097 020016	16 Ø PİRİNÇ RAKOR (KELEPÇELİ)	1 ad.		26,79
012 097 020021	21 Ø PİRİNÇ RAKOR (KELEPÇELİ)	1 ad.		37,50
012 097 020029	29 Ø PİRİNÇ RAKOR (KELEPÇELİ)	1 ad.		53,58
012 097 020036	36 Ø PİRİNÇ RAKOR (KELEPÇELİ)	1 ad.		85,72
012 097 020042	42 Ø PİRİNÇ RAKOR (KELEPÇELİ)	1 ad.		107,15



012 097 030016

057 097 100036

012 097 010135

012 097 010009

012 097 020135

012 097 020009



Kod	Açıklama / Stok Cinsi	Amb. (Kutu)	Amb. Birimi	FİYAT	
PVC. ALEV YAYMAYAN BOY BORULAR					
001 045 120014 30 17	14 Ø PVC. ALEV YAYMAYAN BOY BORU (BOY: 3 MT)	☐ €	102 mt.	2,33	
001 045 120016 30 17	16 Ø PVC. ALEV YAYMAYAN BOY BORU (BOY: 3 MT)	☐ €	102 mt.	2,41	
001 045 120018 30 17	18 Ø PVC. ALEV YAYMAYAN BOY BORU (BOY: 3 MT)	☐ €	102 mt.	3,05	
001 045 120020 30 17	20 Ø PVC. ALEV YAYMAYAN BOY BORU (BOY: 3 MT)	☐ €	102 mt.	3,48	
001 045 120025 30 17	25 Ø PVC. ALEV YAYMAYAN BOY BORU (BOY: 3 MT)	☐ €	51 mt.	4,46	
001 045 120032 30 17	32 Ø PVC. ALEV YAYMAYAN BOY BORU (BOY: 3 MT)	☐ €	30 mt.	7,82	
001 045 120040 30 17	40 Ø PVC. ALEV YAYMAYAN BOY BORU (BOY: 3 MT)	☐ €	30 mt.	14,65	
PVC. ALEV YAYMAYAN KENDİNDEN MUFLU BOY BORULAR					
001 045 110014 30 17	14 Ø PVC. ALEV YAYMAYAN KENDİNDEN MUFLU BOY BORU(3M)	☐ €	102 mt.	3,24	
001 045 110016 30 17	16 Ø PVC. ALEV YAYMAYAN KENDİNDEN MUFLU BOY BORU(3M)	☐ €	102 mt.	3,64	
001 045 110018 30 17	18 Ø PVC. ALEV YAYMAYAN KENDİNDEN MUFLU BOY BORU(3M)	☐ €	102 mt.	3,96	
001 045 110020 30 17	20 Ø PVC. ALEV YAYMAYAN KENDİNDEN MUFLU BOY BORU(3M)	☐ €	102 mt.	4,32	
001 045 110025 30 17	25 Ø PVC. ALEV YAYMAYAN KENDİNDEN MUFLU BOY BORU(3M)	☐ €	51 mt.	5,55	
001 045 110032 30 17	32 Ø PVC. ALEV YAYMAYAN KENDİNDEN MUFLU BOY BORU(3M)	☐ €	30 mt.	9,22	
001 045 110040 30 17	40 Ø PVC. ALEV YAYMAYAN KENDİNDEN MUFLU BOY BORU(3M)	☐ €	30 mt.	16,67	
DİRSEK VE MUFLAR ALEV YAYMAYAN					
001 051 010014 00 17	14 Ø DİRSEK ALEV YAYMAYAN	☐ €	100 ad.	700	0,69
001 051 010016 00 17	16 Ø DİRSEK ALEV YAYMAYAN	☐ €	100 ad.	600	0,75
001 051 010018 00 17	18 Ø DİRSEK ALEV YAYMAYAN	☐ €	100 ad.	400	1,06
001 051 010020 00 17	20 Ø DİRSEK ALEV YAYMAYAN	☐ €	100 ad.	300	1,11
001 051 010025 00 17	25 Ø DİRSEK ALEV YAYMAYAN	☐ €	50 ad.	150	1,86
001 051 010032 00 17	32 Ø DİRSEK ALEV YAYMAYAN	☐ €	50 ad.	100	3,37
001 051 030014 00 17	14-16 Ø MUF ALEV YAYMAYAN	☐ €	100 ad.	700	0,47
001 051 030018 00 17	18-20 Ø MUF ALEV YAYMAYAN	☐ €	100 ad.	500	0,52
001 051 030025 00 17	25 Ø MUF ALEV YAYMAYAN	☐ €	50 ad.	300	0,91
001 051 030032 00 17	32 Ø MUF ALEV YAYMAYAN	☐ €	50 ad.	200	0,97
GEÇMELİ TİP ANTİGRON BORU KROŞELERİ					
001 048 010016 00 17	16 Ø ANTİGRON BORU KROŞESİ (GEÇMELİ)		100 ad.	2000	0,21
001 048 010018 00 17	18 Ø ANTİGRON BORU KROŞESİ (GEÇMELİ)		100 ad.	4000	0,23
001 048 010020 00 17	20 Ø ANTİGRON BORU KROŞESİ (GEÇMELİ)		100 ad.	1500	0,24
001 048 010025 00 17	25 Ø ANTİGRON BORU KROŞESİ (GEÇMELİ)		100 ad.	1000	0,26
001 048 010032 00 17	32 Ø ANTİGRON BORU KROŞESİ (GEÇMELİ)		100 ad.	800	0,29
001 048 010040 00 17	40 Ø ANTİGRON BORU KROŞESİ (GEÇMELİ)		100 ad.	1000	1,26
074 048 050016	16 Ø ANTİGRON BORU KROŞESİ KAPAKLI(GEÇMELİ)		100 ad.	4000	0,36
074 048 050017	20 Ø ANTİGRON BORU KROŞESİ KAPAKLI(GEÇMELİ)		100 ad.	3000	0,39
074 048 050025	25 Ø ANTİGRON BORU KROŞESİ KAPAKLI(GEÇMELİ)		100 ad.	2500	0,74
074 048 050032	32 Ø ANTİGRON BORU KROŞESİ KAPAKLI(GEÇMELİ)		50 ad.	1500	0,91
FİBER SUSTALAR					
999 999 000779	FİBER KLAVUZ 11MM (100-120-150-200M)		1 mt.		3,19 \$
999 999 000780	FİBER KLAVUZ MAKARASI		1 ad.		110,96 \$
PVC. İZOLE KAPLI ÇELİK SUSTA					
049 019 300010	10 MT. PVC.İZOLE KAPLI ÇELİK SUSTA		1 ad.	30	44,98
049 019 300015	15 MT. PVC.İZOLE KAPLI ÇELİK SUSTA		1 ad.	24	67,47
049 019 300020	20 MT. PVC.İZOLE KAPLI ÇELİK SUSTA		1 ad.	20	89,96
049 019 300025	25 MT. PVC.İZOLE KAPLI ÇELİK SUSTA		1 ad.	18	112,44
PLASTİK SUSTALAR (KILAVUZ TELLİ)					
049 019 400010	10 MT.KILAVUZ TELLİ PLASTİK SUSTA		1 ad.	25	12,37
049 019 400015	15 MT.KILAVUZ TELLİ PLASTİK SUSTA		1 ad.	20	18,55
049 019 400020	20 MT.KILAVUZ TELLİ PLASTİK SUSTA		1 ad.	15	24,74
049 019 400025	25 MT KILAVUZ TELLİ PLASTİK SUSTA		1 ad.	15	30,92
ÇELİK SUSTA VE ZİNCİR					
001 019 000010 00 00	SUSTA (1.KALİTE) (10M)		40 ad.	40	28,86
001 019 000015 00 00	SUSTA (1.KALİTE) (15M)		30 ad.	30	40,86
001 019 000020 00 00	SUSTA (1.KALİTE) (20M)		20 ad.	20	52,39
001 019 000025 00 00	SUSTA (1.KALİTE) (25M)		15 ad.	15	64,49
001 019 100010 00 00	TAKVİYELİ SUSTA(1.KALİTE)(10M)		40 ad.	40	31,69
001 019 100015 00 00	TAKVİYELİ SUSTA(1.KALİTE)(15M)		30 ad.	30	46,45
001 019 100020 00 00	TAKVİYELİ SUSTA(1.KALİTE)(20M)		20 ad.	20	57,31
001 019 100025 00 00	TAKVİYELİ SUSTA(1.KALİTE)(25M)		15 ad.	15	72,98
001 018 000001 00 00	FLORESAN ZİNCİRİ		100 mt.	500	1,99

Kod	Açıklama / Stok Cinsi	Amb. (Kutu)	Amb. Birimi	FIYAT
SİBOR HALOJEN FREE ALEV YAYAN BOY BORU (320N)				
001 045 600016 30 17	16 Ø (H.FREE)(A.YAYAN)BOY BORU (3M)(GR)(SİBOR)	102	mt.	2,07
001 045 600020 30 17	20 Ø (H.FREE)(A.YAYAN)BOY BORU (3M)(GR)(SİBOR)	102	mt.	2,59
001 045 600025 30 17	25 Ø (H.FREE)(A.YAYAN)BOY BORU (3M)(GR)(SİBOR)	51	mt.	3,96
001 045 600032 30 17	32 Ø (H.FREE)(A.YAYAN)BOY BORU (3M)(GR)(SİBOR)	30	mt.	6,09
SİBOR HALOJEN FREE ALEV YAYMAYAN BOY BORU (320N)				
001 045 160016 30 17	16 Ø (H.FREE)(A.YAYMAYAN)BOY BORU (3M)(GR)(SİBOR)	102	mt.	3,34
001 045 160020 30 17	20 Ø (H.FREE)(A.YAYMAYAN)BOY BORU (3M)(GR)(SİBOR)	102	mt.	4,17
001 045 160025 30 17	25 Ø (H.FREE)(A.YAYMAYAN)BOY BORU (3M)(GR)(SİBOR)	51	mt.	6,38
001 045 160032 30 17	32 Ø (H.FREE)(A.YAYMAYAN)BOY BORU (3M)(GR)(SİBOR)	30	mt.	9,82
SİBOR HALOJEN FREE ALEV YAYAN BOY BORU (750N)				
001 045 610016 30 17	16 Ø (H.FREE)(A.YAYAN)BOY BORU (3M)(GR)(SİBOR)	102	mt.	2,38
001 045 610020 30 17	20 Ø (H.FREE)(A.YAYAN)BOY BORU (3M)(GR)(SİBOR)	102	mt.	3,35
001 045 610025 30 17	25 Ø (H.FREE)(A.YAYAN)BOY BORU (3M)(GR)(SİBOR)	51	mt.	4,57
001 045 610032 30 17	32 Ø (H.FREE)(A.YAYAN)BOY BORU (3M)(GR)(SİBOR)	30	mt.	7,00
SİBOR HALOJEN FREE ALEV YAYMAYAN BOY BORU (750N)				
001 045 161016 30 17	16 Ø (H.FREE)(A.YAYMAYAN)BOY BORU (3M)(GR)(SİBOR)	102	mt.	3,83
001 045 161020 30 17	20 Ø (H.FREE)(A.YAYMAYAN)BOY BORU (3M)(GR)(SİBOR)	102	mt.	5,40
001 045 161025 30 17	25 Ø (H.FREE)(A.YAYMAYAN)BOY BORU (3M)(GR)(SİBOR)	51	mt.	7,37
001 045 161032 30 17	32 Ø (H.FREE)(A.YAYMAYAN)BOY BORU (3M)(GR)(SİBOR)	30	mt.	11,30
SİBOR HALOJEN FREE ALEV YAYAN BOY BORU (1250N)				
001 045 620020 30 17	20 Ø (H.FREE)(A.YAYAN)BOY BORU (3M)(GR)(SİBOR)	102	mt.	4,11
001 045 620025 30 17	25 Ø (H.FREE)(A.YAYAN)BOY BORU (3M)(GR)(SİBOR)	51	mt.	5,79
SİBOR HALOJEN FREE ALEV YAYMAYAN BOY BORU (1250N)				
001 045 162020 30 17	20 Ø (H.FREE)(A.YAYMAYAN)BOY BORU (3M)(GR)(SİBOR)	102	mt.	6,63
001 045 162025 30 17	25 Ø (H.FREE)(A.YAYMAYAN)BOY BORU (3M)(GR)(SİBOR)	51	mt.	9,33
HALOJEN FREE ALEV YAYMAYAN BOY BORULAR (320N)				
001 045 500016 30 17	16 Ø HALOJEN FREE A.YAYMAYAN BORU(3M)(320N)	102	mt.	7,39
001 045 500020 30 17	20 Ø HALOJEN FREE A.YAYMAYAN BORU(3M)(320N)	102	mt.	9,76
001 045 500025 30 17	25 Ø HALOJEN FREE A.YAYMAYAN BORU(3M)(320N)	102	mt.	13,93
001 045 500032 30 17	32 Ø HALOJEN FREE A.YAYMAYAN BORU(3M)(320N)	102	mt.	18,05
001 045 500040 30 17	40 Ø HALOJEN FREE A.YAYMAYAN BORU(3M)(320N)	51	mt.	22,64
001 045 500050 30 17	50 Ø HALOJEN FREE A.YAYMAYAN BORU(3M)(320N)	30	mt.	47,66
HALOJEN FREE ALEV YAYMAYAN BOY BORULAR (750N)				
001 045 510016 30 17	16 Ø HALOJEN FREE A.YAYMAYAN BORU(3M)(750N)	102	mt.	7,81
001 045 510020 30 17	20 Ø HALOJEN FREE A.YAYMAYAN BORU(3M)(750N)	102	mt.	11,38
001 045 510025 30 17	25 Ø HALOJEN FREE A.YAYMAYAN BORU(3M)(750N)	102	mt.	13,33
001 045 510032 30 17	32 Ø HALOJEN FREE A.YAYMAYAN BORU(3M)(750N)	102	mt.	19,29
001 045 510040 30 17	40 Ø HALOJEN FREE A.YAYMAYAN BORU(3M)(750N)	51	mt.	23,43
001 045 510050 30 17	50 Ø HALOJEN FREE A.YAYMAYAN BORU(3M)(750N)	30	mt.	45,91
HALOJEN FREE ALEV YAYMAYAN BOY BORULAR (1250N)				
001 045 520016 30 17	16 Ø HALOJEN FREE A.YAYMAYAN BORU(3M)(1250N)	102	mt.	8,24
001 045 520020 30 17	20 Ø HALOJEN FREE A.YAYMAYAN BORU(3M)(1250N)	102	mt.	10,36
001 045 520025 30 17	25 Ø HALOJEN FREE A.YAYMAYAN BORU(3M)(1250N)	102	mt.	14,18
001 045 520032 30 17	32 Ø HALOJEN FREE A.YAYMAYAN BORU(3M)(1250N)	102	mt.	20,75
001 045 520040 30 17	40 Ø HALOJEN FREE A.YAYMAYAN BORU(3M)(1250N)	51	mt.	24,22
001 045 520050 30 17	50 Ø HALOJEN FREE A.YAYMAYAN BORU(3M)(1250N)	30	mt.	48,49
ŞEFFAF H.FREE A.YAYAN BORU-SPİRAL EK MUF				
999 999 777616	16 LİK ŞEFFAF H.F ALEV YAYAN BORU-SPİRAL EK MUFU	100 ad.		1,37
999 999 777620	20 LİK ŞEFFAF H.F ALEV YAYAN BORU-SPİRAL EK MUFU	100 ad.		1,56
999 999 777625	25 LİK ŞEFFAF H.F ALEV YAYAN BORU-SPİRAL EK MUFU	100 ad.		1,87
999 999 777632	32 LİK ŞEFFAF H.F ALEV YAYAN BORU-SPİRAL EK MUFU	100 ad.		2,23
DÜZ BORU T DİRSEK H.FREE ALEV YAYMAYAN				
999 999 999888	16 Ø DÜZ BORU T DİRSEK H.FREE ALEV YAYMAYAN	100 ad.	300	2,30
999 999 999889	20 Ø DÜZ BORU T DİRSEK H.FREE ALEV YAYMAYAN	100 ad.	300	2,80
999 999 999890	25 Ø DÜZ BORU T DİRSEK H.FREE ALEV YAYMAYAN	100 ad.	300	3,39
999 999 999891	32 Ø DÜZ BORU T DİRSEK H.FREE ALEV YAYMAYAN	100 ad.	200	4,14
DÜZ BORU REKORU H.FREE ALEV YAYMAYAN				
999 999 998816	16 Ø DÜZ BORU REKORU H.FREE	100 ad.		2,53
999 999 998820	20 Ø DÜZ BORU REKORU H.FREE	100 ad.		2,98
999 999 998825	25 Ø DÜZ BORU REKORU H.FREE	100 ad.		3,27
999 999 998832	32 Ø DÜZ BORU REKORU H.FREE	100 ad.		4,17
ANTİGRON BORU KROŞESİ (GEÇMELİ) H.FREE A.YAYMAYAN				
074 048 060016	16 Ø ANT. BORU KROŞESİ(GEÇMELİ) KAPAKLI H.FREE A.YAYMAYAN	100 ad.		0,57
074 048 060020	20 Ø ANT. BORU KROŞESİ(GEÇMELİ) KAPAKLI H.FREE A.YAYMAYAN	100 ad.		0,63
074 048 060025	25 Ø ANT. BORU KROŞESİ(GEÇMELİ) KAPAKLI H.FREE A.YAYMAYAN	100 ad.		0,72
074 048 060032	32 Ø ANT. BORU KROŞESİ(GEÇMELİ) KAPAKLI H.FREE A.YAYMAYAN	50 ad.		0,84
SPİRAL REKORU H.FREE ALEV YAYMAYAN				
999 999 777516	16 Ø SPİRAL REKORU KAPAKLI H.FREE A.YAYMAYAN	100 ad.		2,14
999 999 777520	20 Ø SPİRAL REKORU KAPAKLI H.FREE A.YAYMAYAN	100 ad.		2,98
999 999 777525	25 Ø SPİRAL REKORU KAPAKLI H.FREE A.YAYMAYAN	100 ad.		3,84
999 999 777532	32 Ø SPİRAL REKORU KAPAKLI H.FREE A.YAYMAYAN	50 ad.		5,06



999 999 777625

999 999 999889

999 999 998825

074 048 060025

999 999 777525



Kod	Açıklama / Stok Cinsi	Amb. (Kutu)	Amb. Birimi	FİYAT
SİBOR SERİSİ H.FREE TURUNCU BORULAR (6 ATÜ) (A.YAYAN) (125N)				
001 165 706014 00 12	14/6 ATÜ BORU (H.FREE) (ALEV YAYAN) SİBOR	100	mt.	0,95
001 165 706016 00 12	16/6 ATÜ BORU (H.FREE) (ALEV YAYAN) SİBOR	100	mt.	1,12
001 165 706018 00 12	18/6 ATÜ BORU (H.FREE) (ALEV YAYAN) SİBOR	100	mt.	1,29
001 165 706020 00 12	20/6 ATÜ BORU (H.FREE) (ALEV YAYAN) SİBOR	100	mt.	1,47
001 165 706025 00 12	25/6 ATÜ BORU (H.FREE) (ALEV YAYAN) SİBOR	100	mt.	2,07
001 165 706032 00 12	32/6 ATÜ BORU (H.FREE) (ALEV YAYAN) SİBOR	100	mt.	3,45
001 165 706037 00 12	37/6 ATÜ BORU (H.FREE) (ALEV YAYAN) SİBOR	100	mt.	4,31
001 165 706040 00 12	40/6 ATÜ BORU (H.FREE) (ALEV YAYAN) SİBOR	100	mt.	4,66
001 165 706050 00 12	50/6 ATÜ BORU (H.FREE) (ALEV YAYAN) SİBOR	100	mt.	7,07
SİBOR SERİSİ H.FREE BORULAR (6 ATÜ) (A.YAYMAYAN)(125N)				
001 165 206014 00 12	14/6 ATÜ BORU (H.FREE) (ALEV YAYMAYAN) SİBOR	100	mt.	1,80
001 165 206016 00 12	16/6 ATÜ BORU (H.FREE) (ALEV YAYMAYAN) SİBOR	100	mt.	2,13
001 165 206018 00 12	18/6 ATÜ BORU (H.FREE) (ALEV YAYMAYAN) SİBOR	100	mt.	2,49
001 165 206020 00 12	20/6 ATÜ BORU (H.FREE) (ALEV YAYMAYAN) SİBOR	100	mt.	2,85
001 165 206025 00 12	25/6 ATÜ BORU (H.FREE) (ALEV YAYMAYAN) SİBOR	100	mt.	3,93
001 165 206032 00 12	32/6 ATÜ BORU (H.FREE) (ALEV YAYMAYAN) SİBOR	100	mt.	6,56
001 165 206037 00 12	37/6 ATÜ BORU (H.FREE) (ALEV YAYMAYAN) SİBOR	100	mt.	8,19
001 165 206040 00 12	40/6 ATÜ BORU (H.FREE) (ALEV YAYMAYAN) SİBOR	100	mt.	8,85
001 165 206050 00 12	50/6 ATÜ BORU (H.FREE) (ALEV YAYMAYAN) SİBOR	100	mt.	13,44
SİBOR SERİSİ H.FREE BORULAR (10 ATÜ) (A.YAYAN) (320N)				
001 165 710014 00 12	14/10 ATÜ BORU (H.FREE) (ALEV YAYAN) SİBOR	100	mt.	1,12
001 165 710016 00 12	16/10 ATÜ BORU (H.FREE) (ALEV YAYAN) SİBOR	100	mt.	1,26
001 165 710018 00 12	18/10 ATÜ BORU (H.FREE) (ALEV YAYAN) SİBOR	100	mt.	1,50
001 165 710020 00 12	20/10 ATÜ BORU (H.FREE) (ALEV YAYAN) SİBOR	100	mt.	1,90
001 165 710025 00 12	25/10 ATÜ BORU (H.FREE) (ALEV YAYAN) SİBOR	100	mt.	2,38
001 165 710032 00 12	32/10 ATÜ BORU (H.FREE) (ALEV YAYAN) SİBOR	100	mt.	3,80
001 165 710037 00 12	37/10 ATÜ BORU (H.FREE) (ALEV YAYAN) SİBOR	100	mt.	5,09
001 165 710040 00 12	40/10 ATÜ BORU (H.FREE) (ALEV YAYAN) SİBOR	100	mt.	6,35
001 165 710050 00 12	50/10 ATÜ BORU (H.FREE) (ALEV YAYAN) SİBOR	100	mt.	8,73
SİBOR SERİSİ H.FREE BORULAR (10 ATÜ)(A.YAYMAYAN)(320N)				
001 165 210014 00 12	14/10 ATÜ BORU (H.FREE) (ALEV YAYMAYAN) SİBOR	100	mt.	2,13
001 165 210016 00 12	16/10 ATÜ BORU (H.FREE) (ALEV YAYMAYAN) SİBOR	100	mt.	2,39
001 165 210018 00 12	18/10 ATÜ BORU (H.FREE) (ALEV YAYMAYAN) SİBOR	100	mt.	2,85
001 165 210020 00 12	20/10 ATÜ BORU (H.FREE) (ALEV YAYMAYAN) SİBOR	100	mt.	3,61
001 165 210025 00 12	25/10 ATÜ BORU (H.FREE) (ALEV YAYMAYAN) SİBOR	100	mt.	4,52
001 165 210032 00 12	32/10 ATÜ BORU (H.FREE) (ALEV YAYMAYAN) SİBOR	100	mt.	7,21
001 165 210037 00 12	37/10 ATÜ BORU (H.FREE) (ALEV YAYMAYAN) SİBOR	100	mt.	9,67
001 165 210040 00 12	40/10 ATÜ BORU (H.FREE) (ALEV YAYMAYAN) SİBOR	100	mt.	12,06
001 165 210050 00 12	50/10 ATÜ BORU (H.FREE) (ALEV YAYMAYAN) SİBOR	100	mt.	16,55
MEKS SERİSİ H.FREE TURUNCU BORULAR (6 ATÜ)(A.YAYAN)(320N)				
001 165 506014 00 12	14/6 ATÜ BORU (H.FREE) (A.YAYAN)	100	mt.	1,05
001 165 506016 00 12	16/6 ATÜ BORU (H.FREE) (A.YAYAN)	100	mt.	1,23
001 165 506018 00 12	18/6 ATÜ BORU (H.FREE) (A.YAYAN)	100	mt.	1,41
001 165 506020 00 12	20/6 ATÜ BORU (H.FREE) (A.YAYAN)	100	mt.	1,72
001 165 506025 00 12	25/6 ATÜ BORU (H.FREE) (A.YAYAN)	100	mt.	2,17
001 165 506032 00 12	32/6 ATÜ BORU (H.FREE) (A.YAYAN)	100	mt.	3,62
001 165 506037 00 12	37/6 ATÜ BORU (H.FREE) (A.YAYAN)	100	mt.	4,53
001 165 506040 00 12	40/6 ATÜ BORU (H.FREE) (A.YAYAN)	100	mt.	5,07
001 165 506050 00 12	50/6 ATÜ BORU (H.FREE) (A.YAYAN)	100	mt.	7,79
001 165 506063 00 12	63/6 ATÜ BORU (H.FREE) (A.YAYAN)	100	mt.	10,87
001 165 506075 00 12	75/6 ATÜ BORU (H.FREE) (A.YAYAN)	100	mt.	15,40
001 165 506090 00 12	90/6 ATÜ BORU (H.FREE) (A.YAYAN)	75	mt.	23,55
MEKS SERİSİ H.FREE TURUNCU BORULAR (10 ATÜ)(A.YAYAN)(750N)				
001 165 510014 00 12	14/10 ATÜ BORU (H.FREE) (A.YAYAN)	100	mt.	1,18
001 165 510016 00 12	16/10 ATÜ BORU (H.FREE) (A.YAYAN)	100	mt.	1,41
001 165 510018 00 12	18/10 ATÜ BORU (H.FREE) (A.YAYAN)	100	mt.	1,72
001 165 510020 00 12	20/10 ATÜ BORU (H.FREE) (A.YAYAN)	100	mt.	2,17
001 165 510025 00 12	25/10 ATÜ BORU (H.FREE) (A.YAYAN)	100	mt.	2,54
001 165 510032 00 12	32/10 ATÜ BORU (H.FREE) (A.YAYAN)	100	mt.	3,98
001 165 510037 00 12	37/10 ATÜ BORU (H.FREE) (A.YAYAN)	100	mt.	5,43
001 165 510040 00 12	40/10 ATÜ BORU (H.FREE) (A.YAYAN)	100	mt.	6,52
001 165 510050 00 12	50/10 ATÜ BORU (H.FREE) (A.YAYAN)	100	mt.	9,42
001 165 510063 00 12	63/10 ATÜ BORU (H.FREE) (A.YAYAN)	100	mt.	13,58
001 165 510075 00 12	75/10 ATÜ BORU (H.FREE) (A.YAYAN)	100	mt.	15,94
001 165 510090 00 12	90/10 ATÜ BORU (H.FREE) (A.YAYAN)	75	mt.	27,17
001 165 510100 00 12	100/10 ATÜ BORU (H.FREE) (A.YAYAN)	50	mt.	32,60
001 165 510110 00 12	110/10 ATÜ BORU (H.FREE) (A.YAYAN)	50	mt.	36,23
MEKS SERİSİ H.FREE TURUNCU BORULAR (A.YAYAN) (1250N)				
001 165 512020 00 12	20 Ø BORU (H.FREE) (A.YAYAN)	100	mt.	2,72
001 165 512025 00 12	25 Ø BORU (H.FREE) (A.YAYAN)	100	mt.	3,98
001 165 512032 00 12	32 Ø BORU (H.FREE) (A.YAYAN)	100	mt.	5,43
MEKS SERİSİ H.FREE TURUNCU BORULAR (6 ATÜ)(A.YAYMAYAN)(320N)				
001 165 106014 00 12	14/6 ATÜ BORU (H.FREE) (A.YAYMAYAN)	100	mt.	2,13
001 165 106016 00 12	16/6 ATÜ BORU (H.FREE) (A.YAYMAYAN)	100	mt.	2,50
001 165 106018 00 12	18/6 ATÜ BORU (H.FREE) (A.YAYMAYAN)	100	mt.	2,87
001 165 106020 00 12	20/6 ATÜ BORU (H.FREE) (A.YAYMAYAN)	100	mt.	3,50
001 165 106025 00 12	25/6 ATÜ BORU (H.FREE) (A.YAYMAYAN)	100	mt.	4,42
001 165 106032 00 12	32/6 ATÜ BORU (H.FREE) (A.YAYMAYAN)	100	mt.	7,36
001 165 106037 00 12	37/6 ATÜ BORU (H.FREE) (A.YAYMAYAN)	100	mt.	9,20
001 165 106040 00 12	40/6 ATÜ BORU (H.FREE) (A.YAYMAYAN)	100	mt.	10,30
001 165 106050 00 12	50/6 ATÜ BORU (H.FREE) (A.YAYMAYAN)	100	mt.	15,82
001 165 106063 00 12	63/6 ATÜ BORU (H.FREE) (A.YAYMAYAN)	100	mt.	22,08
001 165 106075 00 12	75/6 ATÜ BORU (H.FREE) (A.YAYMAYAN)	100	mt.	31,28
001 165 106090 00 12	90/6 ATÜ BORU (H.FREE) (A.YAYMAYAN)	75	mt.	47,84
MEKS SERİSİ H.FREE BORULAR (10 ATÜ)(A.YAYMAYAN)(750N)				
001 165 110014 00 12	14/10 ATÜ BORU (H.FREE) (A.YAYMAYAN)	100	mt.	2,39
001 165 110016 00 12	16/10 ATÜ BORU (H.FREE) (A.YAYMAYAN)	100	mt.	2,87
001 165 110018 00 12	18/10 ATÜ BORU (H.FREE) (A.YAYMAYAN)	100	mt.	3,50
001 165 110020 00 12	20/10 ATÜ BORU (H.FREE) (A.YAYMAYAN)	100	mt.	4,42
001 165 110025 00 12	25/10 ATÜ BORU (H.FREE) (A.YAYMAYAN)	100	mt.	5,15
001 165 110032 00 12	32/10 ATÜ BORU (H.FREE) (A.YAYMAYAN)	100	mt.	8,10
001 165 110037 00 12	37/10 ATÜ BORU (H.FREE) (A.YAYMAYAN)	100	mt.	11,04
001 165 110040 00 12	40/10 ATÜ BORU (H.FREE) (A.YAYMAYAN)	100	mt.	13,25
001 165 110050 00 12	50/10 ATÜ BORU (H.FREE) (A.YAYMAYAN)	100	mt.	19,14
001 165 110063 00 12	63/10 ATÜ BORU (H.FREE) (A.YAYMAYAN)	100	mt.	27,60
001 165 110075 00 12	75/10 ATÜ BORU (H.FREE) (A.YAYMAYAN)	100	mt.	32,38
001 165 110090 00 12	90/10 ATÜ BORU (H.FREE) (A.YAYMAYAN)	75	mt.	55,20
001 165 110100 00 12	100/10 ATÜ BORU (H.FREE) (A.YAYMAYAN)	50	mt.	66,24
001 165 110110 00 12	110/10 ATÜ BORU (H.FREE) (A.YAYMAYAN)	50	mt.	73,60

Kod	Açıklama / Stok Cinsi	Amb. (Kutu)	Amb. Birimi	FIYAT
-----	-----------------------	-------------	-------------	-------

MEKS SERİSİ H.FREE BORULAR (A.YAYMAYAN)(1250N)

001 165 112020 00 12	:20 Ø BORU (H.FREE)(A.YAYMAYAN)	100	mt.	5,52
001 165 112025 00 12	:25 Ø BORU (H.FREE)(A.YAYMAYAN)	100	mt.	8,10
001 165 112032 00 12	:32 Ø BORU (H.FREE)(A.YAYMAYAN)	100	mt.	11,04

MEKS SERİSİ H.FREE TURUNCU BORU (6 ATÜ)(A.YAYAN)(TELLİ)(320N)

001 165 906014 00 12	:Ø14/6 ATÜ BORU(H.FREE)(A.YAYAN)(TELLİ)(TURUNCU)	100	mt.	1,18
001 165 906016 00 12	:Ø16/6 ATÜ BORU(H.FREE)(A.YAYAN)(TELLİ)(TURUNCU)	100	mt.	1,34
001 165 906018 00 12	:Ø18/6 ATÜ BORU(H.FREE)(A.YAYAN)(TELLİ)(TURUNCU)	100	mt.	1,51
001 165 906020 00 12	:Ø20/6 ATÜ BORU(H.FREE)(A.YAYAN)(TELLİ)(TURUNCU)	100	mt.	1,80
001 165 906025 00 12	:Ø25/6 ATÜ BORU(H.FREE)(A.YAYAN)(TELLİ)(TURUNCU)	100	mt.	2,22
001 165 906032 00 12	:Ø32/6 ATÜ BORU(H.FREE)(A.YAYAN)(TELLİ)(TURUNCU)	100	mt.	3,56
001 165 906037 00 12	:Ø37/6 ATÜ BORU(H.FREE)(A.YAYAN)(TELLİ)(TURUNCU)	100	mt.	4,40
001 165 906040 00 12	:Ø40/6 ATÜ BORU(H.FREE)(A.YAYAN)(TELLİ)(TURUNCU)	100	mt.	4,91

MEKS SERİSİ H.FREE TURUNCU BORU (10 ATÜ)(A.YAYAN)(TELLİ)(750N)

001 165 910014 00 12	:Ø14/10 ATÜ BORU(H.FREE)(A.YAYAN)(TELLİ)(TURUNCU)	100	mt.	1,29
001 165 910016 00 12	:Ø16/10 ATÜ BORU(H.FREE)(A.YAYAN)(TELLİ)(TURUNCU)	100	mt.	1,51
001 165 910018 00 12	:Ø18/10 ATÜ BORU(H.FREE)(A.YAYAN)(TELLİ)(TURUNCU)	100	mt.	1,80
001 165 910020 00 12	:Ø20/10 ATÜ BORU(H.FREE)(A.YAYAN)(TELLİ)(TURUNCU)	100	mt.	2,22
001 165 910025 00 12	:Ø25/10 ATÜ BORU(H.FREE)(A.YAYAN)(TELLİ)(TURUNCU)	100	mt.	2,55
001 165 910032 00 12	:Ø32/10 ATÜ BORU(H.FREE)(A.YAYAN)(TELLİ)(TURUNCU)	100	mt.	3,90
001 165 910037 00 12	:Ø37/10 ATÜ BORU(H.FREE)(A.YAYAN)(TELLİ)(TURUNCU)	100	mt.	5,25
001 165 910040 00 12	:Ø40/10 ATÜ BORU(H.FREE)(A.YAYAN)(TELLİ)(TURUNCU)	100	mt.	6,25

MEKS SERİSİ 6 ATÜ BORU(H.FREE)(A.YAYMAYAN)(TELLİ)(320N)

001 165 306014 00 12	:Ø14/6 ATÜ BORU(H.FREE)(A.YAYMAYAN)(TELLİ)(TURUNCU)	100	mt.	2,13
001 165 306016 00 12	:Ø16/6 ATÜ BORU(H.FREE)(A.YAYMAYAN)(TELLİ)(TURUNCU)	100	mt.	2,46
001 165 306018 00 12	:Ø18/6 ATÜ BORU(H.FREE)(A.YAYMAYAN)(TELLİ)(TURUNCU)	100	mt.	2,79
001 165 306020 00 12	:Ø20/6 ATÜ BORU(H.FREE)(A.YAYMAYAN)(TELLİ)(TURUNCU)	100	mt.	3,35
001 165 306025 00 12	:Ø25/6 ATÜ BORU(H.FREE)(A.YAYMAYAN)(TELLİ)(TURUNCU)	100	mt.	4,18
001 165 306032 00 12	:Ø32/6 ATÜ BORU(H.FREE)(A.YAYMAYAN)(TELLİ)(TURUNCU)	100	mt.	6,84
001 165 306037 00 12	:Ø37/6 ATÜ BORU(H.FREE)(A.YAYMAYAN)(TELLİ)(TURUNCU)	100	mt.	8,50
001 165 306040 00 12	:Ø40/6 ATÜ BORU(H.FREE)(A.YAYMAYAN)(TELLİ)(TURUNCU)	100	mt.	9,50

MEKS SERİSİ 10 ATÜ BORU(H.FREE)(A.YAYMAYAN)(TELLİ)(750N)

001 165 310014 00 12	:Ø14/10 ATÜ BORU(H.FREE)(A.YAYMAYAN)(TELLİ)(TURUNCU)	100	mt.	2,36
001 165 310016 00 12	:Ø16/10 ATÜ BORU(H.FREE)(A.YAYMAYAN)(TELLİ)(TURUNCU)	100	mt.	2,79
001 165 310018 00 12	:Ø18/10 ATÜ BORU(H.FREE)(A.YAYMAYAN)(TELLİ)(TURUNCU)	100	mt.	3,35
001 165 310020 00 12	:Ø20/10 ATÜ BORU(H.FREE)(A.YAYMAYAN)(TELLİ)(TURUNCU)	100	mt.	4,18
001 165 310025 00 12	:Ø25/10 ATÜ BORU(H.FREE)(A.YAYMAYAN)(TELLİ)(TURUNCU)	100	mt.	4,85
001 165 310032 00 12	:Ø32/10 ATÜ BORU(H.FREE)(A.YAYMAYAN)(TELLİ)(TURUNCU)	100	mt.	7,51
001 165 310037 00 12	:Ø37/10 ATÜ BORU(H.FREE)(A.YAYMAYAN)(TELLİ)(TURUNCU)	100	mt.	10,16
001 165 310040 00 12	:Ø40/10 ATÜ BORU(H.FREE)(A.YAYMAYAN)(TELLİ)(TURUNCU)	100	mt.	12,15

PLASTİK BORULAR

001 045 000014 30 00	:14 MM KALIN BOY BORU	102 mt.	510 mt.	0,79
001 045 000018 30 00	:18 MM KALIN BOY BORU	102 mt.	510 mt.	0,98
001 045 000026 30 00	:26 MM KALIN BOY BORU	51 mt.	255 mt.	1,90
001 045 000037 30 00	:37 MM KALIN BOY BORU	30 mt.		2,91
001 045 010014 00 11	:14 MM KANGAL (NORMAL)	100 mt.		0,79
001 045 010018 00 11	:18 MM KANGAL (NORMAL)	100 mt.		0,98
001 045 010026 00 11	:26 MM KANGAL (NORMAL)	50 mt.		1,90
001 045 010037 00 11	:37 MM KANGAL (NORMAL)	50 mt.		3,40
001 045 020014 00 00	:14 MM KANGAL (KAUÇUK)	100 mt.		0,77
001 045 020018 00 00	:18 MM KANGAL (KAUÇUK)	100 mt.		1,00
001 045 020026 00 00	:26 MM KANGAL (KAUÇUK)	50 mt.		1,85
001 045 020037 00 00	:37 MM KANGAL (KAUÇUK)	50 mt.		2,91
001 045 030014 00 00	:14 MM KANGAL (KAUÇUK) (KALIN)	100 mt.		0,73
001 045 030018 00 00	:18 MM KANGAL (KAUÇUK) (KALIN)	100 mt.		0,91

PLASTİK DİRSEK VE MUFLAR

127 051 000014	:PLASTİK 14 Ø DİRSEK	100 ad.	2000	0,298
127 051 000018	:PLASTİK 18 Ø DİRSEK	100 ad.	1000	0,357
127 051 000026	:PLASTİK 26 Ø DİRSEK	100 ad.	500	0,506
001 051 020014 00 11	:PLASTİK 14 Ø MUF		1500	0,269
001 051 020018 00 11	:PLASTİK 18 Ø MUF		1000	0,308
001 051 020026 00 11	:PLASTİK 26 Ø MUF		500	0,362
001 051 020037 00 11	:PLASTİK 37 Ø MUF		250	0,447

POLİETİLEN SİYAH YERALTI BORULAR (450N)

001 165 406014 00 11	:14/6 ATÜ POLİETİLEN BORU (SİYAH)	100	mt.	0,77
001 165 406016 00 11	:16/6 ATÜ POLİETİLEN BORU (SİYAH)	100	mt.	0,93
001 165 406018 00 11	:18/6 ATÜ POLİETİLEN BORU (SİYAH)	100	mt.	1,04
001 165 406020 00 11	:20/6 ATÜ POLİETİLEN BORU (SİYAH)	100	mt.	1,26
001 165 406025 00 11	:25/6 ATÜ POLİETİLEN BORU (SİYAH)	100	mt.	1,59
001 165 406032 00 11	:32/6 ATÜ POLİETİLEN BORU (SİYAH)	100	mt.	2,66
001 165 406037 00 11	:37/6 ATÜ POLİETİLEN BORU (SİYAH)	100	mt.	3,32
001 165 406040 00 11	:40/6 ATÜ POLİETİLEN BORU (SİYAH)	100	mt.	3,72
001 165 406050 00 11	:50/6 ATÜ POLİETİLEN BORU (SİYAH)	100	mt.	5,71
001 165 406063 00 11	:63/6 ATÜ POLİETİLEN BORU (SİYAH)	100	mt.	7,97
001 165 406075 00 11	:75/6 ATÜ POLİETİLEN BORU (SİYAH)	100	mt.	11,29
001 165 406090 00 11	:90/6 ATÜ POLİETİLEN BORU (SİYAH)	75	mt.	17,27

POLİETİLEN SİYAH YER ALTI BORULAR (750N)

001 165 410014 00 11	:14/10 ATÜ POLİETİLEN BORU (SİYAH)	100	mt.	0,86
001 165 410016 00 11	:16/10 ATÜ POLİETİLEN BORU (SİYAH)	100	mt.	1,04
001 165 410018 00 11	:18/10 ATÜ POLİETİLEN BORU (SİYAH)	100	mt.	1,26
001 165 410020 00 11	:20/10 ATÜ POLİETİLEN BORU (SİYAH)	100	mt.	1,59
001 165 410025 00 11	:25/10 ATÜ POLİETİLEN BORU (SİYAH)	100	mt.	1,86
001 165 410032 00 11	:32/10 ATÜ POLİETİLEN BORU (SİYAH)	100	mt.	2,92
001 165 410037 00 11	:37/10 ATÜ POLİETİLEN BORU (SİYAH)	100	mt.	3,98
001 165 410040 00 11	:40/10 ATÜ POLİETİLEN BORU (SİYAH)	100	mt.	4,78
001 165 410050 00 11	:50/10 ATÜ POLİETİLEN BORU (SİYAH)	100	mt.	6,91
001 165 410063 00 11	:63/10 ATÜ POLİETİLEN BORU (SİYAH)	100	mt.	9,83
001 165 410075 00 11	:75/10 ATÜ POLİETİLEN BORU (SİYAH)	100	mt.	11,69
001 165 410090 00 11	:90/10 ATÜ POLİETİLEN BORU (SİYAH)	75	mt.	19,92
001 165 410100 00 11	:100/10 ATÜ POLİETİLEN BORU (SİYAH)	50	mt.	23,91
001 165 410110 00 11	:110/10 ATÜ POLİETİLEN BORU (SİYAH)	50	mt.	26,56





Kod	Açıklama / Stok Cinsi	Amb. (Kutu)	Amb. Birimi	FİYAT
-----	-----------------------	-------------	-------------	-------

PLASTİK KASA-BUAT-TAKOZLAR

126 046 130103	NORM KASA	100 ad.	1000	0,33
126 046 130104	NORM BUAT (14-18 ÇIKIŞLI)	50 ad.	500	0,72
126 046 130105	NORM BUAT KAPAKSIZ	50 ad.	500	0,57
001 046 160102 00 11	GEÇMELİ PLASTİK KASA	100 ad.	400	1,39
126 046 130106	GEÇMELİ DERİN KASA	100 ad.	500	0,69
126 046 130107	GEÇMELİ DERİN KASA KAPAKSIZ	100 ad.	500	0,57
001 046 120101 00 11	ALÇIPAN KASA 1'Lİ	75 ad.	300	1,82
001 046 120102 00 11	ALÇIPAN KASA 2'Lİ	50 ad.	200	2,70
001 046 120103 00 11	ALÇIPAN KASA 3'Lİ	25 ad.	100	3,87
001 046 120100 00 11	GEÇMELİ ALÇ.KASA SİYAH	50 ad.	300	1,53
001 046 170101 00 11	TÜNEL KASA	100 ad.	500	1,88
001 046 170102 00 11	TÜNEL BUAT	50 ad.	300	1,71
001 046 000001 00 11	PLASTİK TAKOZ (14-18 ÇIKIŞLI)	100 ad.	1000	0,76

TURUNCU KASA VE BUATLAR H.FREE (ALEV YAYMAYAN)

001 046 131202 00 12	NORM KASA (TURUNCU) (H.FREE) (ALEV YAYMAYAN)	100 ad.	1000	0,93
001 046 131201 00 12	NORM BUAT (TURUNCU) (H.FREE) (ALEV YAYMAYAN)	50 ad.	500	1,49
001 046 161201 00 12	GEÇMELİ DERİN KASA (TURUNCU) (H.FREE) (ALEV YAYMAYAN)	100 ad.	500	1,49

TURUNCU KASA VE BUATLAR H.FREE (ALEV YAYAN)

001 046 130202 00 12	NORM KASA (TURUNCU) (H.FREE) (ALEV YAYAN)	100 ad.	1000	0,75
001 046 130201 00 12	NORM BUAT (TURUNCU) (H.FREE) (ALEV YAYAN)	50 ad.	500	1,31
001 046 160201 00 12	GEÇMELİ DERİN KASA (TURUNCU) (H.FREE) (ALEV YAYAN)	100 ad.	500	1,31

TURUNCU KASA VE BUATLAR (ALEV YAYAN)

001 046 130102 00 12	NORM KASA (TURUNCU)(ALEV YAYAN)	100 ad.	1000	0,60
001 046 130101 00 12	NORM BUAT (TURUNCU)(ALEV YAYAN)	50 ad.	500	1,12
001 046 160102 00 12	GEÇMELİ PLASTİK KASA (TURUNCU)(ALEV YAYAN)	100 ad.	400	1,43
001 046 160101 00 12	GEÇMELİ DERİN KASA (TURUNCU)(ALEV YAYAN)	100 ad.	500	1,12
001 046 170101 00 12	TÜNEL KASA (TURUNCU)(ALEV YAYAN)	100 ad.	500	2,10
001 046 170102 00 12	TÜNEL BUAT (TURUNCU)(ALEV YAYAN)	50 ad.	300	1,75
001 046 120101 00 12	ALÇIPAN KASA 1'Lİ (TURUNCU)(ALEV YAYAN)	75 ad.	300	1,85
001 046 120102 00 12	ALÇIPAN KASA 2'Lİ (TURUNCU)(ALEV YAYAN)	50 ad.	200	2,75
001 046 120103 00 12	ALÇIPAN KASA 3'LÜ (TURUNCU)(ALEV YAYAN)	25 ad.	100	3,95
001 046 120100 00 12	GEÇMELİ ALÇIPAN KASA (TURUNCU)(ALEV YAYAN)	50 ad.	300	1,84

TURUNCU KASA VE BUATLAR (ALEV YAYMAYAN)

001 046 131102 00 12	NORM KASA (TURUNCU)(ALEV YAYMAYAN)	100 ad.	1000	0,91
001 046 131101 00 12	NORM BUAT (TURUNCU)(ALEV YAYMAYAN)	50 ad.	500	1,31
001 046 161102 00 12	GEÇMELİ PLASTİK KASA (TURUNCU)(ALEV YAYMAYAN)	100 ad.	400	1,54
001 046 161101 00 12	GEÇMELİ DERİN KASA (TURUNCU)(ALEV YAYMAYAN)	100 ad.	500	1,31
001 046 210002 00 12	TÜNEL KASA (TURUNCU)(ALEV YAYMAYAN)	100 ad.	500	2,72
001 046 210003 00 12	TÜNEL BUAT (TURUNCU)(ALEV YAYMAYAN)	50 ad.	300	3,10
001 046 121101 00 12	ALÇIPAN KASA 1'Lİ (TURUNCU)(ALEV YAYMAYAN)	75 ad.	300	1,95
001 046 121102 00 12	ALÇIPAN KASA 2'Lİ (TURUNCU)(ALEV YAYMAYAN)	50 ad.	200	2,91
001 046 121103 00 12	ALÇIPAN KASA 3'LÜ (TURUNCU)(ALEV YAYMAYAN)	25 ad.	100	4,16
001 046 121100 00 12	GEÇMELİ ALÇIPAN KASA (TURUNCU)(ALEV YAYMAYAN)	50 ad.	300	2,17

BETON DUVAR ANAHTAR KASALARI (ALEV YAYAN)

000 700 000037 00 14	BUAT ARKA KAPAK SARI (ALEV YAYAN)	50 ad.	500	0,47
000 700 000035 00 12	BUAT GÖVDE 60'LİK TURUNCU (ALEV YAYAN)	50 ad.	350	1,05
000 700 000256 00 14	KALIBA TESPİT ELEMANI SARI (ALEV YAYAN)		250	0,67
000 700 000039 00 12	SİĞ BRÜT ANAH. KASASI TURUNCU (ALEV YAYAN)	100 ad.	500	2,02
000 700 000036 00 14	KONİK GÖVDE SARI (ALEV YAYAN)	50 ad.	250	0,88
000 700 000214 00 14	APLIK 20'LİK SARI (ALEV YAYAN)	100 ad.	1000	0,38
000 700 000215 00 12	APLIK EĞİK BAĞLANTI DIRSEĞİ TURUNCU (ALEV YAYAN)	100 ad.	1000	0,34

BETON DUVAR ANAHTAR KASALARI (ALEV YAYMAYAN)

000 700 200037 00 14	BUAT ARKA KAPAK SARI (ALEV YAYMAYAN)	50 ad.	500	0,52
000 700 200035 00 12	BUAT GÖVDE 60'LİK TURUNCU (ALEV YAYMAYAN)	50 ad.	350	1,06
000 700 200256 00 14	KALIBA TESPİT ELEMANI SARI (ALEV YAYMAYAN)		250	0,78
000 700 200039 00 12	SİĞ BRÜT ANAH. KASASI TURUNCU (ALEV YAYMAYAN)	100 ad.	500	2,06
000 700 200036 00 14	KONİK GÖVDE SARI (ALEV YAYMAYAN)	50 ad.	250	1,01
000 700 200214 00 14	APLIK 20'LİK SARI (ALEV YAYMAYAN)	100 ad.	1000	0,38
000 700 200215 00 12	APLIK EĞİK BAĞLANTI DIRSEĞİ TURUNCU (ALEV YAYMAYAN)	100 ad.	1000	0,41

KARE BUAT

001 046 021010 00 11	10X10 KARE BUAT (SİYAH)	10 ad.	300	5,97
001 046 021212 00 11	12X12 KARE BUAT (SİYAH)	10 ad.	200	6,28
001 046 021515 00 11	15X15 KARE BUAT (SİYAH)	10 ad.	120	11,25
001 046 022020 00 11	20X20 KARE BUAT (SİYAH)	10 ad.	70	14,47
001 046 000103 00 11	ANTİGRON BUAT 3'LÜ PLASTİK (SİYAH)	10 ad.	240	6,73
001 046 000104 00 11	ANTİGRON BUAT 4'LÜ PLASTİK (SİYAH)	10 ad.	240	7,07
001 046 000103 00 00	ANTİGRON BUAT 3'LÜ PLASTİK (BEYAZ)	10 ad.	240	7,35
001 046 000104 00 00	ANTİGRON BUAT 4'LÜ PLASTİK (BEYAZ)	10 ad.	240	7,63

TURUNCU KARE BUAT

001 046 021010 00 12	10X10 KARE BUAT TURUNCU	10 ad.	300	6,50
001 046 021212 00 12	12X12 KARE BUAT TURUNCU	10 ad.	200	6,80
001 046 021515 00 12	15X15 KARE BUAT TURUNCU	10 ad.	120	12,56
001 046 022020 00 12	20X20 KARE BUAT TURUNCU	10 ad.	70	16,40
001 046 000103 00 12	ANTİGRON BUAT 3'LÜ TURUNCU	10 ad.	240	7,53
001 046 000104 00 12	ANTİGRON BUAT 4'LÜ TURUNCU	10 ad.	240	7,63

TURUNCU KARE BUAT (A.YAYMAYAN)

001 046 051010 00 12	KARE BUAT TURUNCU(10X10) (A.YAYMAYAN)	10 ad.	300	7,10
001 046 051212 00 12	KARE BUAT TURUNCU(12X12) (A.YAYMAYAN)	10 ad.	200	7,25
001 046 051515 00 12	KARE BUAT TURUNCU(15X15) (A.YAYMAYAN)	10 ad.	120	13,10
001 046 052020 00 12	KARE BUAT TURUNCU(20X20) (A.YAYMAYAN)	10 ad.	70	18,27

Kod	Açıklama / Stok Cinsi	Amb. (Kutu)	Amb. Birimi	FIYAT
-----	-----------------------	-------------	-------------	-------

LÜX BUAT KAPAKLARI

126 046 180001	LÜX BUAT KAPAĞI(BOMBELI-PLS. AYAK)	100 ad.	1000	0,569
126 046 180003	LÜX BUAT KAPAĞI(DUZ PLS. AYAK)	100 ad.	1000	0,601
126 046 180004	LUX BUAT KAPAĞI(BOMB.PLS.AYAK)VIDALI	100 ad.	1000	0,901

KARE BUAT KAPAKLARI

000 700 000043 00 00	10X10 KARE BUAT KAPAĞI	1 ad.	300	1,416
000 700 000045 00 00	12X12 KARE BUAT KAPAĞI	1 ad.	200	1,509
000 700 000047 00 00	15X15 KARE BUAT KAPAĞI	1 ad.	200	2,941
000 700 000049 00 00	20X20 KARE BUAT KAPAĞI	1 ad.	100	3,350

MUTLUSAN BETON ÇİVİLİ KROŞELER

032 048 070000	NO:0 BETON ÇİVİLİ KROŞE(0.75 YASSIKORD.)	MUTLUSAN	1000ad.	30000	0,043
032 048 070001	NO:1 BETON ÇİVİLİ KROŞE(0.75 YASSIKORD.)	MUTLUSAN	1000ad.	30000	0,043
032 048 070002	NO:2 BETON ÇİVİLİ KROŞE(0.75 YASSIKORD.)	MUTLUSAN	1000ad.	20000	0,043
032 048 070003	NO:3 BETON ÇİVİLİ KROŞE (2X1.5-3X1.5)	MUTLUSAN	1000ad.	20000	0,059
032 048 070004	NO:4 BETON ÇİVİLİ KROŞE (2X4)	MUTLUSAN	1000ad.	20000	0,059
032 048 070005	NO:5 BETON ÇİVİLİ KROŞE (2X4-4X4)	MUTLUSAN	1000ad.	10000	0,085
032 048 070006	NO:6 BETON ÇİVİLİ KROŞE (2X6)	MUTLUSAN	1000ad.	10000	0,085
032 048 070007	NO:7 BETON ÇİVİLİ KROŞE (4X10)	MUTLUSAN	1000ad.	8000	0,169
032 048 070008	NO:8 BETON ÇİVİLİ KROŞE (3X16+10)	MUTLUSAN	600ad.	5000	0,211

GALVANİZLİ SAÇ KROŞELER

001 048 060001 00 00	NO. 1 TEKLI GALVANİZ SAÇ KROŞE 12MM	1500ad.		0,183
001 048 060002 00 00	NO. 2 TEKLI GALVANİZ SAÇ KROŞE 14MM	1000ad.		0,168
001 048 060003 00 00	NO. 3 TEKLI GALVANİZ SAÇ KROŞE 17MM	700ad.		0,205
001 048 060004 00 00	NO. 4 TEKLI GALVANİZ SAÇ KROŞE 20MM	500ad.		0,225
001 048 060007 00 00	NO. 7 TEKLI GALVANİZ SAÇ KROŞE 26MM	350ad.		0,282
001 048 060008 00 00	NO. 8 TEKLI GALVANİZ SAÇ KROŞE 34MM	250ad.		0,865
001 048 060009 00 00	NO. 9 TEKLI GALVANİZ SAÇ KROŞE 43MM	200ad.		0,982
001 048 060010 00 00	NO. 10 TEKLI GALVANİZ SAÇ KROŞE 53MM	150ad.		1,045
001 048 060011 00 00	NO. 11 TEKLI GALVANİZ SAÇ KROŞE 55MM	120ad.		1,158
001 048 070002 00 00	NO. 2 ÇİFTLİ GALVANİZ SAÇ KROŞE 13MM	600ad.		0,205
001 048 070003 00 00	NO. 3 ÇİFTLİ GALVANİZ SAÇ KROŞE 16MM	500ad.		0,242
001 048 070004 00 00	NO. 4 ÇİFTLİ GALVANİZ SAÇ KROŞE 22MM	400ad.		0,245
001 048 070007 00 00	NO. 7 ÇİFTLİ GALVANİZ SAÇ KROŞE 25MM	400ad.		0,296
001 048 070008 00 00	NO. 8 ÇİFTLİ GALVANİZ SAÇ KROŞE 35MM	300ad.		0,954
001 048 070009 00 00	NO. 9 ÇİFTLİ GALVANİZ SAÇ KROŞE 45MM	200ad.		1,147
001 048 070010 00 00	NO. 10 ÇİFTLİ GALVANİZ SAÇ KROŞE 50MM	150ad.		1,216
001 048 070011 00 00	NO. 11 ÇİFTLİ GALVANİZ SAÇ KROŞE 55MM	100ad.		1,273

RAY KROŞE VE TANDIR KROŞELER

035 048 100001	NO. 1 RAY KROŞE (2X1.5-4X2.5)	350 ad.		0,616
035 048 100002	NO. 2 RAY KROŞE (4X4-4X16)	250 ad.		0,650
001 025 010100 00 00	GALVANİZ KROŞE RAYI (1M)	50 ad.		7,621
035 048 110001	NO. 1 TANDIR KROŞE (2X1.5-2X6)	350 ad.		0,595
035 048 110002	NO. 2 TANDIR KROŞE (4X6)	250 ad.		0,595
035 048 110003	NO. 3 TANDIR KROŞE (4X10)	250 ad.		0,595
035 048 110004	NO. 4 TANDIR KROŞE (4X16)	150 ad.		0,714
035 048 110005	NO. 5 TANDIR KROŞE (3X25+16)	150 ad.		0,714

PLASTİK DÜBELLER

016 053 000014	BURGULU ALÇIBAN DÜBELİ (YENİ)	100 ad.	10000	0,149
016 053 308100	8X100MM BOŞLUK DÜBELİ	100 ad.	10000	0,201
001 053 000001 00 00	ALÇIBAN DÜBEL	100 ad.	15000	0,110
001 053 000002 00 00	KANAL DÜBELİ	1000ad.	14000	0,088
016 053 000006	6 MM BEYAZ DÜBEL	1000ad.	35000	0,031
016 053 000007	7 MM BEYAZ DÜBEL	1000ad.	25000	0,034
016 053 000008	8 MM BEYAZ DÜBEL	1000ad.	20000	0,040

DÜBELLİ KROŞELER

001 048 090002 00 17	3/13 TEKLI KABLO KROŞESİ	500 ad.	10000	0,063
001 048 090006 00 17	8/28 TEKLI KABLO KROŞESİ	500 ad.	5000	0,074
001 048 090001 00 00	ÇİFTLİ KABLO KROŞESİ	100 ad.	2500	0,082
001 048 090003 00 17	16'LİK BORU KELEPÇESİ	100 ad.	2000	0,094
001 048 090004 00 17	20'LİK BORU KELEPÇESİ	100 ad.	1500	0,173
001 048 090005 00 17	25'LİK BORU KELEPÇESİ	100 ad.	1000	0,240

KANCA VİDALAR

013 099 032060	20X60 KANCA VİDA	1 grs.	144	38,895
013 099 032070	20X70 KANCA VİDA	1 grs.	144	40,120
013 099 032080	20X80 KANCA VİDA	1 grs.	100	29,070

YILDIZ BAŞLI AĞAÇ VİDALARI

013 099 012030	20X30 VİDA YILDIZ BAŞLI	1 grs.	12 grs.	10,644
013 099 012035	20X35 VİDA YILDIZ BAŞLI	1 grs.	12 grs.	11,876
013 099 012040	20X40 VİDA YILDIZ BAŞLI	1 grs.	12 grs.	12,695
013 099 012045	20X45 VİDA YILDIZ BAŞLI	1 grs.	12 grs.	14,332
013 099 012050	20X50 VİDA YILDIZ BAŞLI	1 grs.	12 grs.	15,557

SUNTA VİDASI ÇİNKO KAPLAMA

013 099 040435	4X35 SUNTA VİDASI (500 ADET FİYATI)	1 grs.		37,663
013 099 040440	4X40 SUNTA VİDASI (500 ADET FİYAT)	1 grs.		42,576
013 099 040445	4X45 SUNTA VİDASI (500 ADET FİYAT)	1 grs.		45,032
013 099 040450	4X50 SUNTA VİDASI (450 ADET FİYATI)	1 grs.		43,808
013 099 040540	5X40 SUNTA VİDASI (200 ADET FİYATI)	1 grs.		24,976
013 099 040545	5X45 SUNTA VİDASI (200 ADET FİYATI)	1 grs.		28,251
013 099 040550	5X50 SUNTA VİDASI (200 ADET FİYATI)	1 grs.		32,096
013 099 040560	5X60 SUNTA VİDASI (200 ADET FİYATI)	1 grs.		36,439



YENİ

GEÇMELİ TİP ve TIRNAKLI TİP BUAT KLEMENSLER

swiss SERİSİ



YENİ



Kod	Açıklama / Stok Cinsi	Amb. (Kutu)	Amb. Birimi	FİYAT
swiss GEÇMELİ BUAT KLEMENS				
999 094 225000	2'Lİ GEÇMELİ BUAT KLEMENS	100 ad.	6000	0,094 \$
999 094 325000	3'LÜ GEÇMELİ BUAT KLEMENS	100 ad.	6000	0,114 \$
999 094 425000	4'LÜ GEÇMELİ BUAT KLEMENS	100 ad.	6000	0,131 \$
999 094 525000	5'Lİ GEÇMELİ BUAT KLEMENS	100 ad.	6000	0,142 \$
swiss TIRNAKLI BUAT KLEMENS				
999 094 241000	2'Lİ TIRNAKLI BUAT KLEMENS	100 ad.	2400	0,200 \$
999 094 341000	3'LÜ TIRNAKLI BUAT KLEMENS	100 ad.	2400	0,262 \$
999 094 541000	5'Lİ TIRNAKLI BUAT KLEMENS	50 ad.	1200	0,414 \$
WAGO BUAT KLEMENSLERİ CE				
999 094 280225	2X2.5 MM WAGO BUAT KLEMENSİ	1000	ad.	0,156 €
999 094 280325	3X2.5 MM WAGO BUAT KLEMENSİ	1000	ad.	0,171 €
999 094 280425	4X2.5 MM WAGO BUAT KLEMENSİ	1000	ad.	0,215 €
999 094 280525	5X2.5 MM WAGO BUAT KLEMENSİ	1000	ad.	0,234 €
999 094 280825	8X2.5 MM WAGO BUAT KLEMENSİ	500	ad.	0,418 €
WAGO KOMPAKT ÇOK AMAÇLI KLEMENS CE				
999 094 300412	221-412 İKİLİ ÇOK AMAÇLI KOMPAKT KLEMENS	1000	ad.	0,369 €
999 094 300413	221-413 ÜÇLÜ ÇOK AMAÇLI KOMPAKT KLEMENS	500	ad.	0,471 €
999 094 300415	221-415 BEŞLİ ÇOK AMAÇLI KOMPAKT KLEMENS	250	ad.	0,751 €
GEÇMELİ BUAT KLEMENSLERİ				
888 094 260802	BM802 GEÇMELİ BUAT KLEMENSİ (2'Lİ)	400	6400	0,094 \$
015 094 160001	NO. 2 ZEYTİN (BUAT) KLEMENS	1000	5000	0,16
ŞEFFAF ISIYA DAYANIKLI BUAT KLEMESLER				
888 094 000105	NO.2 ŞEFFAF BUAT KLEMENS (1 ADET FİYAT)	560	ad.	0,59
888 094 000205	NO.3 ŞEFFAF BUAT KLEMENS (1 ADET FİYAT)	360	ad.	0,83
888 094 000405	NO.4 ŞEFFAF BUAT KLEMENS (1 ADET FİYAT)	300	ad.	1,36
888 094 000605	NO.5 ŞEFFAF BUAT KLEMENS (1 ADET FİYAT)	160	ad.	1,85

	Açıklama / Stok Cinsi	Amb. (Kutu)	Amb. Birimi	FIYAT
GEÇMELİ SOKET KLEMENS				
999 999 991212	12'Lİ GEÇMELİ SOKET KLEMENS	25 ad.		21,25
PLASTİK SIRA KLEMENSLER				
015 094 150001	NO. 1 SIRA KLEMENSLER (2.5-4 MM2)	50 ad.	1000	3,58
015 094 150002	NO. 2 SIRA KLEMENSLER (4-6 MM2)	50 ad.	1000	4,71
015 094 150003	NO. 3 SIRA KLEMENSLER (6-10 MM2)	50 ad.	500	5,79
015 094 150004	NO. 4 SIRA KLEMENSLER (10-16 MM2)	50 ad.	500	6,15
015 094 150005	NO. 5 SIRA KLEMENSLER (16-25 MM2)	50 ad.	500	7,24
ISIYA DAYANIKLI SIRA KLEMENSLER CE				
015 094 170001	NO. 1 ISIYA DAYANIKLI KLEMENSLER (2.5-4 MM2)	50 ad.	1000	3,97
015 094 170002	NO. 2 ISIYA DAYANIKLI KLEMENSLER (4-6 MM2)	50 ad.	1000	5,12
015 094 170003	NO. 3 ISIYA DAYANIKLI KLEMENSLER (6-10 MM2)	50 ad.	500	6,41
015 094 170004	NO. 4 ISIYA DAYANIKLI KLEMENSLER (10-16 MM2)	50 ad.	500	6,72
015 094 170005	NO. 5 ISIYA DAYANIKLI KLEMENSLER (16-25 MM2)	50 ad.	500	8,01
PORSELEN KLEMENSLER				
015 094 180002	NO. 1-2'Lİ PORSELEN KLEMENS	300 ad.		1,38
015 094 180003	NO. 1-3'LÜ PORSELEN KLEMENS	220 ad.		1,94
015 094 180004	NO. 2-2'Lİ PORSELEN KLEMENS	200 ad.		1,94
015 094 180005	NO. 2-3'LÜ PORSELEN KLEMENS	177 ad.		2,75
015 094 180006	NO. 3-2'Lİ PORSELEN KLEMENS	104 ad.		2,75
015 094 180007	NO. 3-3'Lİ PORSELEN KLEMENS	64 ad.		3,65
U KLEMENSLER				
014 094 030006	6'LİK U KLEMENS	300 ad.		2,06
014 094 030010	10'LÜK U KLEMENS	250 ad.		3,18
014 094 030016	16'LİK U KLEMENS	100 ad.		4,49
014 094 030025	25'LİK U KLEMENS	100 ad.		5,21
014 094 030035	35'LİK U KLEMENS	75 ad.		6,37
014 094 030050	50'LİK U KLEMENS	50 ad.		9,70
014 094 030070	70'LİK U KLEMENS	40 ad.		10,86
014 094 030095	95'LİK U KLEMENS	25 ad.		15,35
014 094 030120	120'LİK U KLEMENS	20 ad.		18,53
014 094 030150	150'LİK U KLEMENS	15 ad.		26,78
MOTOR KLEMENSLER				
022 094 200001	NO. 1 MOTOR KLEMENS	50 ad.		6,47
022 094 200002	NO. 2 MOTOR KLEMENS	50 ad.		7,50
022 094 200003	NO. 3 MOTOR KLEMENS	50 ad.		9,70
022 094 200004	NO. 4 MOTOR KLEMENS	40 ad.		14,13
022 094 200005	NO. 5 MOTOR KLEMENS	15 ad.		19,43
022 094 200006	NO. 6 MOTOR KLEMENS	6 ad.		46,77
AL-CU KLEMENSLER				
014 094 050025	A25 - B16 AL-CU KLEMENS	100 ad.		8,87
014 094 050040	A40 - B25 AL-CU KLEMENS	100 ad.		9,91
014 094 050070	A70 - B50 AL-CU KLEMENS	50 ad.		15,86
014 094 050120	A120 - B70 AL-CU KLEMENS	50 ad.		26,01
BRANŞMAN KLEMENSLER				
014 094 060025	A25 - A25 BRANŞMAN KLEMENS	80 ad.		5,06
014 094 060040	A40 - A40 BRANŞMAN KLEMENS	30 ad.		6,16
014 094 060070	A70 - A70 BRANŞMAN KLEMENS	30 ad.		10,54
014 094 060120	A120 - A120 BRANŞMAN KLEMENS	25 ad.		17,23
TIRNAKLI KLEMENSLER				
014 094 100001	NO:1 TIRNAKLI KLEMENS 16MM	500 ad.		4,86
014 094 100002	NO:2 TIRNAKLI KLEMENS 25MM	250 ad.		5,10
014 094 100003	NO:3 TIRNAKLI KLEMENS 35MM	100 ad.		7,41
014 094 100004	NO:4 TIRNAKLI KLEMENS 50MM	100 ad.		8,48
014 094 100005	NO:5 TIRNAKLI KLEMENS 70MM	100 ad.		14,48
014 094 100006	NO:6-7 TIRNAKLI KLEMENS 95MM	50 ad.		23,60

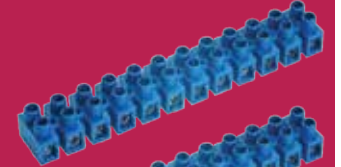



ASPIRATÖR ÇEŞİTLERİ



MUTLUSAN ASPIRATÖR ÇEŞİTLERİ



100 mm

Çalışma Akımı Operation Voltage	220-240V / 50-60Hz
Emiş Hacmi Airflow	100m ³ /h
Devir Hız Round Speed	2250 rpm
Güç Power	12W

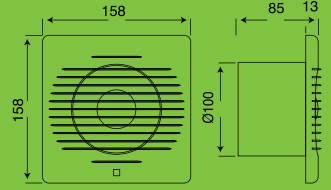

Ürün Kodu : 001 111 000100 00 00
Ürün Adı : MUTLUSAN 100 ASPIRATÖR
Amb. Ad./Koli : 1/20
FİYAT : 46,58 TL



120 mm

Çalışma Akımı Operation Voltage	220-240V / 50-60Hz
Emiş Hacmi Airflow	120m ³ /h
Devir Hız Round Speed	1900 rpm
Güç Power	15W

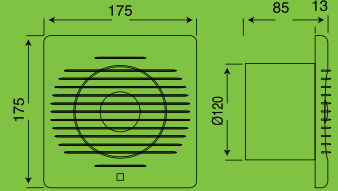

Ürün Kodu : 001 111 000120 00 00
Ürün Adı : MUTLUSAN 120 ASPIRATÖR
Amb. Ad./Koli : 1/20
FİYAT : 48,67 TL



150 mm

Çalışma Akımı Operation Voltage	220-240V / 50-60Hz
Emiş Hacmi Airflow	150m ³ /h
Devir Hız Round Speed	1800 rpm
Güç Power	20W

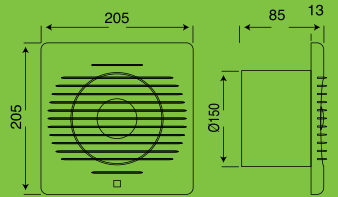

Ürün Kodu : 001 111 000150 00 00
Ürün Adı : MUTLUSAN 150 ASPIRATÖR
Amb. Ad./Koli : 1/20
FİYAT : 65,18 TL



200 mm

Çalışma Akımı Operation Voltage	220-240V / 50-60Hz
Emiş Hacmi Airflow	200m ³ /h
Devir Hız Round Speed	2000 rpm
Güç Power	40W

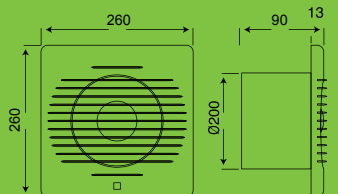

Ürün Kodu : 001 111 000200 00 00
Ürün Adı : MUTLUSAN 200 ASPIRATÖR
Amb. Ad./Koli : 1/8
FİYAT : 126,65 TL

AIRCOL ASPİRATÖR ÇEŞİTLERİ



ÜRÜN KODU
029 088 110100
ÜRÜN ADI
AIRCOL 100
ASPİRATÖR
AMBALAJ ADET / KOLİ
1 ad. / 10
FİYAT
83,42 TL



ÜRÜN KODU
029 088 120100
ÜRÜN ADI
AIRCOL 100 ASPİRATÖR
(OTOMATİK PANJURLU)
AMBALAJ ADET / KOLİ
1 ad. / 10
FİYAT
141,17 TL



ÜRÜN KODU
029 088 130043
ÜRÜN ADI
AIRCOL-100KT KANAL
TİPİ ASPİRATÖR
AMBALAJ ADET / KOLİ
1 ad. / 10
FİYAT
74,43 TL



ÜRÜN KODU
029 088 110120
ÜRÜN ADI
AIRCOL 120
ASPİRATÖR
AMBALAJ ADET / KOLİ
1 ad. / 10
FİYAT
93,68 TL



ÜRÜN KODU
029 088 120120
ÜRÜN ADI
AIRCOL 120 ASPİRATÖR
(OTOMATİK PANJURLU)
AMBALAJ ADET / KOLİ
1 ad. / 10
FİYAT
161,70 TL



ÜRÜN KODU
029 088 130044
ÜRÜN ADI
AIRCOL-120KT KANAL
TİPİ ASPİRATÖR
AMBALAJ ADET / KOLİ
1 ad. / 10
FİYAT
85,98 TL



ÜRÜN KODU
029 088 110150
ÜRÜN ADI
AIRCOL 150
ASPİRATÖR
AMBALAJ ADET / KOLİ
1 ad. / 10
FİYAT
119,35 TL



ÜRÜN KODU
029 088 120150
ÜRÜN ADI
AIRCOL 150 ASPİRATÖR
(OTOMATİK PANJURLU)
AMBALAJ ADET / KOLİ
1 ad. / 10
FİYAT
192,50 TL



ÜRÜN KODU
029 088 130045
ÜRÜN ADI
AIRCOL-150KT KANAL
TİPİ ASPİRATÖR
AMBALAJ ADET / KOLİ
1 ad. / 10
FİYAT
110,37 TL



ÜRÜN KODU
029 088 110200
ÜRÜN ADI
AIRCOL 200
ASPİRATÖR
AMBALAJ ADET / KOLİ
1 ad. / 10
FİYAT
157,85 TL



ÜRÜN KODU
029 088 140250
ÜRÜN ADI
AIRCOL 250-K ASP.
(TAVAN TİPİ)
AMBALAJ ADET / KOLİ
1 ad. / 6
FİYAT
288,75 TL



ÜRÜN KODU
080 088 012060
ÜRÜN ADI
BDRS 120-60 AC RADYAL
FAN (90W 2400 DEV/DAK)
AMBALAJ ADET / KOLİ
1 ad. / 10
FİYAT
295,17 TL

MUTLUSAN ASPİRATÖR ÇEŞİTLERİ

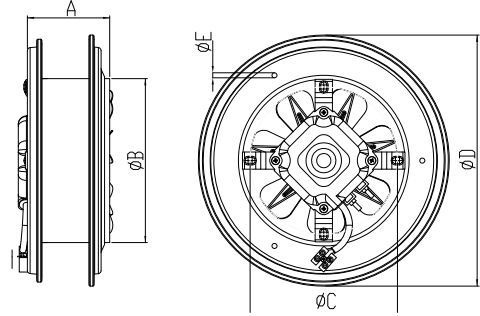

KOD	AÇIKLAMA	GÜÇ - Watt	HIZ - Devir/Dk	A	B	C	D	E	ADET	FİYAT
080 088 160160	MB160MM BACA ASPİRATÖR	25	1450	82	162	148	236	5	1	222,22
080 088 160200	MB200MM BACA ASPİRATÖR	28	1250	82	202	178	282	5	1	244,44
080 088 160250	MB250MM BACA ASPİRATÖR	48	1450	82	248	234	332	5	1	327,78
080 088 160300	MB300MM BACA ASPİRATÖR	50	1350	82	298	284	380	5	1	366,67

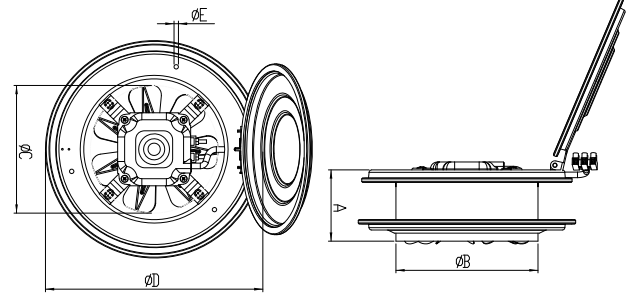

KOD	AÇIKLAMA	GÜÇ - Watt	HIZ - Devir/Dk	A	B	C	D	E	ADET	FİYAT
080 088 200160	MK160MM KAPAKLI ASPİRATÖR	25	1450	100	162	148	236	5	1	244,44
080 088 200200	MK200MM KAPAKLI ASPİRATÖR	28	1250	100	202	178	282	5	1	272,22
080 088 200250	MK250MM KAPAKLI ASPİRATÖR	48	1450	100	248	234	332	5	1	355,56
080 088 200300	MK300MM KAPAKLI ASPİRATÖR	50	1350	100	298	284	380	5	1	416,67

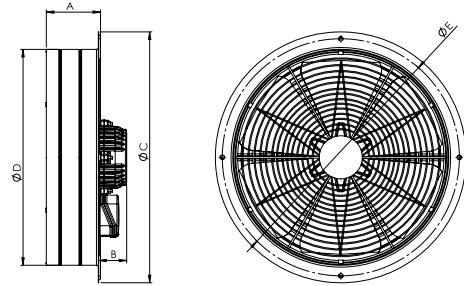

KOD	AÇIKLAMA	GÜÇ - Watt	HIZ - Devir/Dk	A	B	C	D	E	ADET	FİYAT
080 088 002250	MSM250-2K MONOFAZE SANAYİ ASP.	150/190	2900/3250	114	61	304	251	277	1	500,00
080 088 000250	MSM250 MONOFAZE SANAYİ ASP.	65/75	1475/1770	114	61	304	251	277	1	444,44
080 088 000300	MSM300 MONOFAZE SANAYİ ASP.	90/110	1445/1700	114	61	390	325	360	1	500,00
080 088 000350	MSM350 MONOFAZE SANAYİ ASP.	160	1460/1750	114	61	435	374	405	1	522,22
080 088 000400	MSM400 MONOFAZE SANAYİ ASP.	185	1425/1725	114	61	485	427	455	1	555,56
080 088 000450	MSM450 MONOFAZE SANAYİ ASP.	200/190	1430/1730	114	61	546	470	516	1	583,33
080 088 000500	MSM500 MONOFAZE SANAYİ ASP.	230	1440/1700	125	61	590	518	560	1	666,67
080 088 000550	MSM550 MONOFAZE SANAYİ ASP.	220/320	1440/1700	130	160	624	560	595	1	816,67
080 088 000600	MSM600 MONOFAZE SANAYİ ASP.	235/340	1400/1670	130	160	674	610	645	1	816,67

KOD	AÇIKLAMA	GÜÇ - Watt	HIZ - Devir/Dk	A	B	C	D	E	ADET	FİYAT
080 088 102250	MST250-2K TRİFAZE SANAYİ ASP.	110/140	2900/3250	114	61	304	251	277	1	500,00
080 088 100250	MST250 TRİFAZE SANAYİ ASP.	50/60	1475/1770	114	61	304	251	277	1	444,44
080 088 100300	MST300 TRİFAZE SANAYİ ASP.	70/85	1445/1700	114	61	390	325	360	1	500,00
080 088 100350	MST350 TRİFAZE SANAYİ ASP.	120	1460/1750	114	61	435	374	405	1	522,22
080 088 100400	MST400 TRİFAZE SANAYİ ASP.	150	1425/1725	114	61	485	427	455	1	555,56
080 088 100450	MST450 TRİFAZE SANAYİ ASP.	170/200	1430/1730	114	61	546	470	516	1	583,33
080 088 100500	MST500 TRİFAZE SANAYİ ASP.	200	1440/1700	125	61	590	518	560	1	666,67
080 088 100550	MST550 TRİFAZE SANAYİ ASP.	220/320	1440/1700	130	160	624	560	595	1	816,67
080 088 100600	MST600 TRİFAZE SANAYİ ASP.	235/340	1400/1670	130	160	674	610	645	1	816,67

LED

ACIL
AYDINLATMA
ARMATÜRLERİ







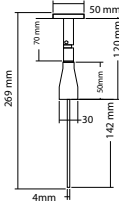
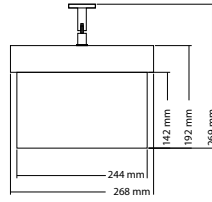



























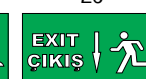























102 038 0008XX - CEXA

- *GÖVDE : ABS
- *CAM : Polistren (PS) isteğe bağlı Akriлик(PMMA) veya Policarbon(PC)
- *BASKI : Akriлик ışık geçirgen Translucent Folyo
- *ÇALIŞMA : Acil de ve Şebeke de sürekli çalışma
- *PİL : 3.6V 80mAH NİMH (NikelMethalhidrid)
- *ŞARJ SÜRESİ : 14-20 Saat
- *DEŞARJ SÜRESİ : 60 Dk veya isteğe bağlı 180 Dk
- *KORUMA SINIFI : IP20
- *LED : 4.8mm 6000K Beyaz Mantar Led veya 2835 6400K EDİSON OPTO SMD Led
- TÜKETİM : 2 Watt

Fiyat: 104,18 TL

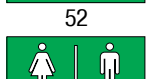
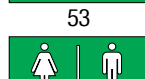
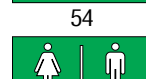
102 038 0009XX - CEXA-FS

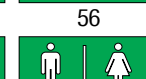
- * ABS gövde
- * Kristal (PS) cam (İsteğe bağlı Akriлик (PMMA) ve Polikarbon (PC) cam
- * 100 micron akrilik fosfor blok
- * 0.40 Akriлик Phosphor Folyo
- * 2-4 saat Fosfor ışık yansıması (İsteğe bağlı 4-6 saat/6-8 saat/8-12 saat)
- * Işık depolama uygun ışık yoğunluğun sa 6-8 saat
- * Sudan ve Nemden etkilenez * Fosforlu
- * IP65

Fiyat: 74,41 TL

							
01	02	03	04	05	06	07	08
							
09	10	11	12	13	14		
							
15	16	17	18	19	20		
							
21	22	23	24	25	26		
							
27	28	29	30	31	32		
							
33	34	35	36				
							
37	38	39	40	41	42	43	
							
44	45	46	47	48	49	50	51
							
52	53	54	55	56	57	58	59
							
60	61	62	63	64	65		

*Sipariş Verdiğiniz Ürünün Sembol Kodunu Yazmayı Unutmayınız.

*Ürün Kodunun Son 2 hanesi olan XX Rakamları Ürünün Sembol Kodunu belirtmektedir.

ÇİFT YÜZLÜ YÖN TAVAN SERİSİ LEDLİ ACİL DURUM ARMATÜRLERİ IP20

**ÇİFT YÜZLÜ SIVA ALTI SERİSİ
LEDLİ ACİL DURUM ARMATÜRLERİ**



Kombine bir modeldir,
Hem aydınlatma hem de yönlendirmeyi sağlar.
Dekoratif ABS gövde
Acilde veya sürekli çalışma
1 veya 3 saat yanma süresi
NI-CD Uzun ömürlü batarya
Pleksiglas üzeri gravür uygulama
Tavana siva altı uygulama
Ultra parlak ledler
Aşırı şarj ve deşarja karşı koruma
Şarj olma süresi 24 saat

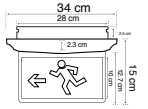

112 038 6000-XX
352,10 TL

**ÇİFT YÜZLÜ SIVA ÜSTÜ SERİSİ
LEDLİ ACİL DURUM ARMATÜRLERİ**



Kombine bir modeldir,
Hem aydınlatma hem de yönlendirmeyi sağlar.
Dekoratif ABS gövde
Acilde veya sürekli çalışma
1 veya 3 saat yanma süresi
NI-CD Uzun ömürlü batarya
Pleksiglas üzeri gravür uygulama
Tavana siva üstü uygulama
Ultra parlak ledler
Aşırı şarj ve deşarja karşı koruma
Şarj olma süresi 24 saat



112 038 5000-XX
337,20 TL

**BİLGİ SERİSİ LEDLİ
ACİL DURUM ARMATÜRLERİ**



Acilde 1 veya 3 saat seçeneği
NI-CD Uzun ömürlü batarya
Sürekli veya acilde yanma imkanı
340x90x48 mm ölçülerinde
Akrilik üzeri folyo veya UV boyama
Şarj olma süresi 24 Saat

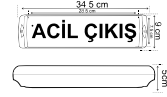

112 038 4000-XX
160,10 TL

SEMBOL KOD TABLOSU

01	02	03	04	05	06
07	08	09	10	11	12
13	14	15	16	17	18

*Yazı Karakteri Olan Ürünler Tek Yüzlüdür.

*Sipariş Verdiğiniz Ürünün Sembol Kodunu Yazmayı Unutmayınız.

*Ürün Kodunun Son 2 hanesi olan XX Rakamları Ürünün Sembol Kodunu belirtmektedir.

Standart sembol seçenekleri dışında istenilen sembol uygulanabilir.

LEDLİ ACİL AYDINLATMA ARMATÜRLERİ



17,34,51 led seçenekleri ile
Acilde veya sürekli çalışma
1 veya 3 saat yanma süresi
NI-CD Uzun ömürlü batarya
Dekoratif ABS gövde
Tavana siva altı uygulama
Ultra parlak ledler
Aşırı şarj ve deşarja karşı koruma
Şarj olma süresi 24 saat
Besleme / Şarj / Hata gösterge ledleri
Dahili test butonu
Düşük bakım maliyeti

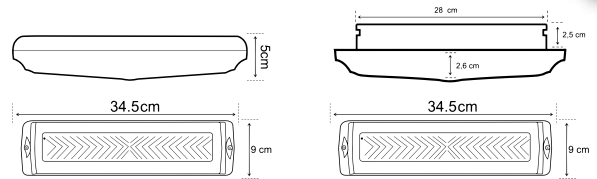

Turkey
Discover the potential

YENİ

Ürün Kodu	Açıklama / Stok Cinsi	Ambalaj (Kutulu)	TL
112 039 011717	17 Ledli S/Ü Acil Aydınlatma Armatürü	1 ad.	219,90
112 039 013434	34 Ledli S/Ü Acil Aydınlatma Armatürü	1 ad.	236,96
112 039 015151	51 Ledli S/Ü Acil Aydınlatma Armatürü	1 ad.	261,30
112 039 121717	17 Ledli S/A Acil Aydınlatma Armatürü	1 ad.	234,52
112 039 123434	34 Ledli S/A Acil Aydınlatma Armatürü	1 ad.	251,57
112 039 125151	51 Ledli S/A Acil Aydınlatma Armatürü	1 ad.	275,92

ARMATÜR Çeşitleri



LED

Yeni
New



**Yeni
New**

LED ARMATÜR ÇEŞİTLERİ

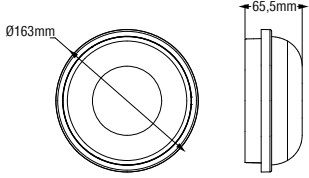

ÜRÜN KODU
016 038 701100
ÜRÜN ADI
LEDLIGHT-1
LEDLİ ARMATÜR (BEYAZ)
LÜMEN / WATT
15W / 1500Lm
KELVİN
6400K
AMBALAJ ADET / KOLİ
30
FİYAT
34,23 TL

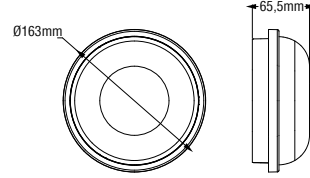

ÜRÜN KODU
016 038 701111
ÜRÜN ADI
LEDLIGHT-1
LEDLİ ARMATÜR (SİYAH)
LÜMEN / WATT
15W / 1500Lm
KELVİN
6400K
AMBALAJ ADET / KOLİ
30
FİYAT
34,23 TL

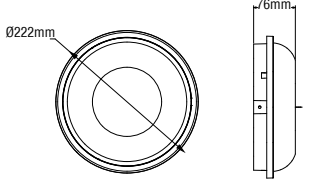

ÜRÜN KODU
016 038 701200
ÜRÜN ADI
LEDLIGHT-2
LEDLİ ARMATÜR (BEYAZ)
LÜMEN / WATT
20W / 2000Lm
KELVİN
6400K
AMBALAJ ADET / KOLİ
20
FİYAT
43,16 TL

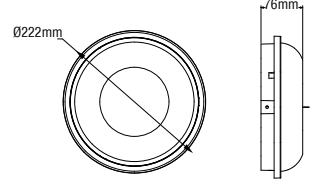

ÜRÜN KODU
016 038 701211
ÜRÜN ADI
LEDLIGHT-2
LEDLİ ARMATÜR (SİYAH)
LÜMEN / WATT
20W / 2000Lm
KELVİN
6400K
AMBALAJ ADET / KOLİ
20
FİYAT
43,16 TL

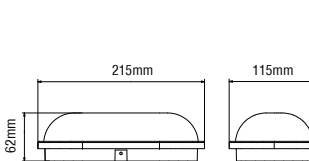

ÜRÜN KODU
016 038 701300
ÜRÜN ADI
LEDLIGHT-3
LEDLİ ARMATÜR (BEYAZ)
LÜMEN / WATT
20W / 2000Lm
KELVİN
6400K
AMBALAJ ADET / KOLİ
30
FİYAT
34,29 TL

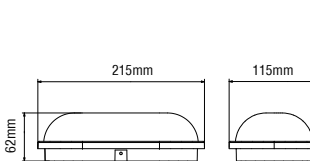

ÜRÜN KODU
016 038 701311
ÜRÜN ADI
LEDLIGHT-3
LEDLİ ARMATÜR (SİYAH)
LÜMEN / WATT
20W / 2000Lm
KELVİN
6400K
AMBALAJ ADET / KOLİ
30
FİYAT
34,29 TL

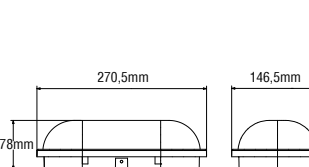

ÜRÜN KODU
016 038 701400
ÜRÜN ADI
LEDLIGHT-4
LEDLİ ARMATÜR (BEYAZ)
LÜMEN / WATT
20W / 2000Lm
KELVİN
6400K
AMBALAJ ADET / KOLİ
20
FİYAT
43,16 TL

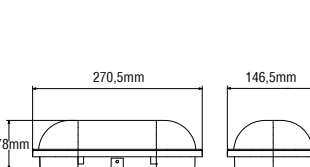

ÜRÜN KODU
016 038 701411
ÜRÜN ADI
LEDLIGHT-4
LEDLİ ARMATÜR (SİYAH)
LÜMEN / WATT
20W / 2000Lm
KELVİN
6400K
AMBALAJ ADET / KOLİ
20
FİYAT
43,16 TL

ARMATÜR ÇEŞİTLERİ
YENİ

CE

ÜRÜN KODU
 016 038 250020
ÜRÜN ADI
 HAZIR ASKI TİJ TAKIMI
 (PLASTİK DUYLU)
AMBALAJ ADET / KOLİ
 50/300
FİYAT
 3,00 TL



CE

ÜRÜN KODU
 016 038 250031
ÜRÜN ADI
 TAVAN GLOP ARMATÜRÜ
 (MİNİ)
AMBALAJ ADET / KOLİ
 48
FİYAT
 7,51 TL



CE

ÜRÜN KODU
 001 038 250018 00 00
ÜRÜN ADI
 HAZIR ASKI TİJ
 TAKIMI
AMBALAJ ADET / KOLİ
 25/300
FİYAT
 4,20 TL



CE

ÜRÜN KODU
 001 038 120101 00 00
ÜRÜN ADI
 ORKIDE TAVAN
 ARMATÜRÜ
AMBALAJ ADET / KOLİ
 48
FİYAT
 12,06 TL



CE

ÜRÜN KODU
 001 038 250019 00 00
ÜRÜN ADI
 HAZIR ASKI TİJ
 TAKIMI (MUHAFAZALI)
AMBALAJ ADET / KOLİ
 50/200
FİYAT
 4,32 TL



CE

ÜRÜN KODU
 001 038 160101 00 00
ÜRÜN ADI
 YONCA TAVAN
 ARMATÜRÜ
AMBALAJ ADET / KOLİ
 48
FİYAT
 11,98 TL



CE

ÜRÜN KODU
 001 038 250016 00 00
ÜRÜN ADI
 PAPATYA HAZIR ASKI
 TİJ TAKIMI
AMBALAJ ADET / KOLİ
 25/275
FİYAT
 4,40 TL



CE

ÜRÜN KODU
 016 038 250013
ÜRÜN ADI
 DUVAR APLİK
 (KRALIÇE)
AMBALAJ ADET / KOLİ
 12/48
FİYAT
 11,91 TL



CE

ÜRÜN KODU
 001 038 250017 00 00
ÜRÜN ADI
 BÜYÜK PAPATYA HAZIR
 ASKI TİJ TAKIMI
AMBALAJ ADET / KOLİ
 10/80
FİYAT
 6,73 TL



ÜRÜN KODU
 078 039 100005
ÜRÜN ADI
 NERGİS APLİK
AMBALAJ ADET / KOLİ
 8/64
FİYAT
 17,56 TL

ARMATÜR ÇEŞİTLERİ

<p>YENİ</p>	001 038 250022 00 00	360° SENSÖRLÜ TAVAN ARM. (2X25 W)		12	67,22
	001 038 250021 00 00	360° SENSÖRLÜ TAVAN ARM. (2X25 W)(PİL DAHİL)		12	112,93
	YENİ 001 038 250052 00 00	360° SENSÖRLÜ TAVAN ARM. (2X25W)		12	130,00
	YENİ 001 038 250051 00 00	360° SENSÖRLÜ TAVAN ARM. ACİL KİTLİ (2X25W)		12	215,10



ÜRÜN KODU
016 038 250044
ÜRÜN ADI
SENSÖRLÜ 80 LEDLİ BEYAZ
ARMATÜR (PİL DAHİL)
AMBALAJ ADET / KOLİ
10
FİYAT
161,33 TL



ÜRÜN KODU
016 038 250061
ÜRÜN ADI
LEDLİ SENSÖRLÜ TAVAN
ARMATÜRÜ
AMBALAJ ADET / KOLİ
10
FİYAT
115,62 TL



ÜRÜN KODU
016 038 600080
ÜRÜN ADI
SENSÖRLÜ 80 LEDLİ KROM
ARMATÜR (PİL DAHİL)
AMBALAJ ADET / KOLİ
10
FİYAT
182,84 TL



ÜRÜN KODU
016 038 250060
ÜRÜN ADI
LEDLİ SENSÖRLÜ TAVAN
ARMATÜRÜ (PİL DAHİL)
AMBALAJ ADET / KOLİ
10
FİYAT
153,27 TL



ÜRÜN KODU
078 039 500100
ÜRÜN ADI
SENSÖRLÜ DUVAR APLİK
E-27 DUYLU
AMBALAJ ADET / KOLİ
20
FİYAT
69,91 TL



ÜRÜN KODU
016 038 250062
ÜRÜN ADI
LEDLİ CAMLI TAVAN
ARMATÜRÜ
AMBALAJ ADET / KOLİ
10
FİYAT
80,67 TL



ÜRÜN KODU
078 039 500110
ÜRÜN ADI
SENSÖRLÜ DUVAR APLİK
LEDLİ
AMBALAJ ADET / KOLİ
20
FİYAT
118,31 TL



NEMLİYER ARMATÜR ÇEŞİTLERİ



CE

ÜRÜN KODU
016 038 411100
ÜRÜN ADI
AQUA KAFESLİ APLİK
(BEYAZ) IP54
AMBALAJ ADET / KOLİ
1/20
FİYAT
18,90 TL



Max:20W

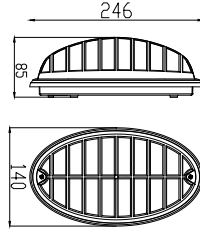

CE

ÜRÜN KODU
016 038 411111
ÜRÜN ADI
AQUA KAFESLİ APLİK
(SİYAH) IP54
AMBALAJ ADET / KOLİ
1/20
FİYAT
18,90 TL



Max:20W



CE

ÜRÜN KODU
016 038 411300
ÜRÜN ADI
OPAK KAFESLİ ARMATÜR
(BEYAZ) IP54
AMBALAJ ADET / KOLİ
1/24
FİYAT
22,32 TL



Max:20W

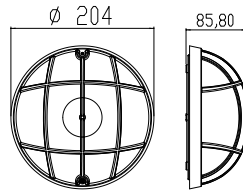

CE

ÜRÜN KODU
016 038 411311
ÜRÜN ADI
OPAK KAFESLİ ARMATÜR
(SİYAH) IP54
AMBALAJ ADET / KOLİ
1/24
FİYAT
22,32 TL



Max:20W



CE

ÜRÜN KODU
016 038 410600
ÜRÜN ADI
ELİPS OPAK ARMATÜR
(KREM) IP65
AMBALAJ ADET / KOLİ
1/10
FİYAT
45,39 TL



Max:20W

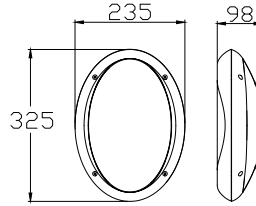

CE

ÜRÜN KODU
016 038 410611
ÜRÜN ADI
ELİPS OPAK ARMATÜR
(SİYAH) IP65
AMBALAJ ADET / KOLİ
1/10
FİYAT
45,39 TL



Max:20W



CE

ÜRÜN KODU
016 038 410500
ÜRÜN ADI
OPAL ARMATÜR
(KREM) IP65
AMBALAJ ADET / KOLİ
1/10
FİYAT
45,39 TL



Max:20W

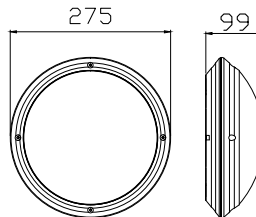

CE

ÜRÜN KODU
016 038 410511
ÜRÜN ADI
OPAL ARMATÜR
(SİYAH) IP65
AMBALAJ ADET / KOLİ
1/10
FİYAT
45,39 TL



Max:20W



CE

ÜRÜN KODU
016 038 410800
ÜRÜN ADI
OPAK ARMATÜR
(BEYAZ) IP54
AMBALAJ ADET / KOLİ
1/16
FİYAT
28,28 TL



Max:20W

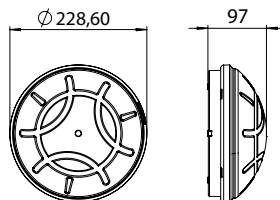

CE

ÜRÜN KODU
016 038 410811
ÜRÜN ADI
OPAK ARMATÜR
(SİYAH) IP54
AMBALAJ ADET / KOLİ
1/16
FİYAT
28,28 TL



Max:20W



NEMLİYER ARMATÜR ÇEŞİTLERİ

<p>CE</p>	<p>ÜRÜN KODU 016 038 700100 ÜRÜN ADI DOLUNAY OPAK ARMATÜR (BEYAZ) IP54 AMBALAJ ADET / KOLİ 1/16 FİYAT 30,51 TL</p> <p>Max: 20W</p>		<p>CE</p>	<p>ÜRÜN KODU 016 038 700111 ÜRÜN ADI DOLUNAY OPAK ARMATÜR (SİYAH) IP54 AMBALAJ ADET / KOLİ 1/16 FİYAT 30,51 TL</p> <p>Max: 20W</p>
<p>CE</p>	<p>ÜRÜN KODU 016 038 700200 ÜRÜN ADI DOLUNAY ŞEFFAF ARMATÜR (BEYAZ) IP54 AMBALAJ ADET / KOLİ 1/16 FİYAT 30,51 TL</p> <p>Max: 20W</p>		<p>CE</p>	<p>ÜRÜN KODU 016 038 700211 ÜRÜN ADI DOLUNAY ŞEFFAF ARMATÜR (SİYAH) IP54 AMBALAJ ADET / KOLİ 1/16 FİYAT 30,51 TL</p> <p>Max: 20W</p>
<p>CE</p>	<p>ÜRÜN KODU 016 038 700300 ÜRÜN ADI DOLUNAY OPAK APLİK (BEYAZ) IP54 AMBALAJ ADET / KOLİ 1/20 FİYAT 27,98 TL</p> <p>Max: 20W</p>		<p>CE</p>	<p>ÜRÜN KODU 016 038 700311 ÜRÜN ADI DOLUNAY OPAK APLİK (SİYAH) IP54 AMBALAJ ADET / KOLİ 1/20 FİYAT 27,98 TL</p> <p>Max: 20W</p>
<p>CE</p>	<p>ÜRÜN KODU 016 038 700400 ÜRÜN ADI DOLUNAY ŞEFFAF APLİK (BEYAZ) IP54 AMBALAJ ADET / KOLİ 1/20 FİYAT 27,98 TL</p> <p>Max: 20W</p>		<p>CE</p>	<p>ÜRÜN KODU 016 038 700411 ÜRÜN ADI DOLUNAY ŞEFFAF APLİK (SİYAH) IP54 AMBALAJ ADET / KOLİ 1/20 FİYAT 27,98 TL</p> <p>Max: 20W</p>

ARMATÜR ÇEŞİTLERİ

<p>TSE CE</p>	<p>ÜRÜN KODU 001 038 020201 00 00 ÜRÜN ADI FULYA DUVAR APLİK AMBALAJ ADET / KOLİ 2/20 FİYAT 16.49 TL</p>	<p>TSE CE</p>	<p>ÜRÜN KODU 001 038 090101 00 00 ÜRÜN ADI YASEMİN DUVAR APLİK AMBALAJ ADET / KOLİ 2/24 FİYAT 19,65 TL</p>
<p>TSE CE</p>	<p>ÜRÜN KODU 001 038 010201 00 00 ÜRÜN ADI MANOLYA DUVAR APLİK AMBALAJ ADET / KOLİ 2/20 FİYAT 14.67 TL</p>	<p>TSE CE</p>	<p>ÜRÜN KODU 001 038 080101 00 00 ÜRÜN ADI YASEMİN OVAL ARMATÜR AMBALAJ ADET / KOLİ 2/24 FİYAT 18,22 TL</p>

CAM ARMATÜR ÇEŞİTLERİ



ÜRÜN KODU
079 039 140003
ÜRÜN ADI
DEKORATİF CAM ARMATÜR
ÇİFT DUYLU (BEYAZ)
AMBALAJ ADET / KOLİ
12
FİYAT
72,60 TL



ÜRÜN KODU
078 039 130002
ÜRÜN ADI
CAM ARMATÜR ÇİFT
DUYLU (BEYAZ)
AMBALAJ ADET / KOLİ
12
FİYAT
47,73 TL



ÜRÜN KODU
079 039 140002
ÜRÜN ADI
DEKORATİF CAM ARMATÜR
ÇİFT DUYLU (KROM)
AMBALAJ ADET / KOLİ
12
FİYAT
94,65 TL



ÜRÜN KODU
078 039 130001
ÜRÜN ADI
CAM ARMATÜR ÇİFT
DUYLU (KROM)
AMBALAJ ADET / KOLİ
12
FİYAT
55,79 TL



ÜRÜN KODU
079 039 140005
ÜRÜN ADI
CAM ARMATÜR
GÜNEŞ 30 Ø
AMBALAJ ADET / KOLİ
12
FİYAT
47,73 TL



ÜRÜN KODU
078 039 130130
ÜRÜN ADI
CAM ARMATÜR
MARTI 30 Ø
AMBALAJ ADET / KOLİ
12
FİYAT
47,73 TL



ÜRÜN KODU
079 039 140004
ÜRÜN ADI
CAM ARMATÜR
GÜNEŞ 25 Ø
AMBALAJ ADET / KOLİ
20
FİYAT
43,02 TL



ÜRÜN KODU
078 039 130125
ÜRÜN ADI
CAM ARMATÜR
MARTI 25 Ø
AMBALAJ ADET / KOLİ
12
FİYAT
43,02 TL



ÜRÜN KODU
079 039 140001
ÜRÜN ADI
YARIM AY CAM APLİK
GÜNEŞ
AMBALAJ ADET / KOLİ
20
FİYAT
43,02 TL



ÜRÜN KODU
078 039 130200
ÜRÜN ADI
YARIMAY CAM APLİK
MARTI
AMBALAJ ADET / KOLİ
20
FİYAT
43,02 TL



ARMATÜR ÇEŞİTLERİ



ÜRÜN KODU
001 038 050101 00 00
ÜRÜN ADI
YASEMİN UFO KÜRE TAVAN
ARMATÜRÜ
AMBALAJ ADET / KOLİ
12
FİYAT
19,90 TL



ÜRÜN KODU
078 039 100006
ÜRÜN ADI
ÇİFT DUYLU TAVAN
ARMATÜR
AMBALAJ ADET / KOLİ
2/32
FİYAT
29,77 TL



ÜRÜN KODU
001 038 070101 00 00
ÜRÜN ADI
YASEMİN UFO DÜZ TAVAN
ARMATÜRÜ
AMBALAJ ADET / KOLİ
12
FİYAT
17,04 TL



ÜRÜN KODU
001 038 010101 00 00
ÜRÜN ADI
MANOLYA TAVAN
ARMATÜRÜ
AMBALAJ ADET / KOLİ
5
FİYAT
23,66 TL



ÜRÜN KODU
001 038 040101 00 00
ÜRÜN ADI
YASEMİN UFO TAVAN
ARMATÜRÜ
AMBALAJ ADET / KOLİ
12
FİYAT
20,13 TL



ÜRÜN KODU
001 038 020101 00 00
ÜRÜN ADI
FULYA TAVAN
ARMATÜRÜ
AMBALAJ ADET / KOLİ
5
FİYAT
22,56 TL



ÜRÜN KODU
001 038 060101 00 00
ÜRÜN ADI
YASEMİN KÜRE TAVAN
ARMATÜRÜ
AMBALAJ ADET / KOLİ
12
FİYAT
20,38 TL



ÜRÜN KODU
001 038 180101 00 00
ÜRÜN ADI
AKASYA TAVAN
ARMATÜRÜ
AMBALAJ ADET / KOLİ
5
FİYAT
22,26 TL



ÜRÜN KODU
001 038 030101 00 00
ÜRÜN ADI
YASEMİN DÜZ TAVAN
ARMATÜRÜ
AMBALAJ ADET / KOLİ
12
FİYAT
20,41 TL

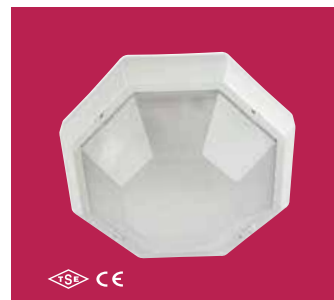

ÜRÜN KODU
001 038 170101 00 00
ÜRÜN ADI
KAMELYA TAVAN
ARMATÜRÜ
AMBALAJ ADET / KOLİ
5
FİYAT
30,21 TL

ARMATÜR ÇEŞİTLERİ



CE

ÜRÜN KODU
016 038 250028
ÜRÜN ADI
OVAL DÜZ
ARMATÜR
AMBALAJ ADET / KOLİ
48
FİYAT
10,89 TL



CE

ÜRÜN KODU
016 038 501018
ÜRÜN ADI
POLİKARBON GÖVDE
KAFESLİ CAM ARMATÜR IP40
AMBALAJ ADET / KOLİ
2/20
FİYAT
43,00 TL



CE

ÜRÜN KODU
016 038 250029
ÜRÜN ADI
OVAL KAFESLİ
ARMATÜR
AMBALAJ ADET / KOLİ
48
FİYAT
11,04 TL



CE

ÜRÜN KODU
016 038 502018
ÜRÜN ADI
POLİKARBON GÖVDE TEL
KAFESLİ CAM ARM. IP 40
AMBALAJ ADET / KOLİ
2/20
FİYAT
63,50 TL



TS CE

ÜRÜN KODU
001 038 150101 00 00
ÜRÜN ADI
BEGONYA NEMLİYER TAVAN
ARMATÜRÜ(KLASİK) IP54
AMBALAJ ADET / KOLİ
12
FİYAT
38,44 TL



YENİ

ÜRÜN KODU
999 999 001051
ÜRÜN ADI
DÖKÜM ARMATÜR
(BEYAZ) IP40
AMBALAJ ADET / KOLİ
2/20
FİYAT
105,34 TL



TS CE

ÜRÜN KODU
001 038 130101 00 00
ÜRÜN ADI
BEGONYA NEMLİYER TAVAN
ARMATÜRÜ (DİKEY) IP54
AMBALAJ ADET / KOLİ
12
FİYAT
38,44 TL



YENİ

ÜRÜN KODU
999 999 001053
ÜRÜN ADI
DÖKÜM ARMATÜR
(SİYAH) IP40
AMBALAJ ADET / KOLİ
2/20
FİYAT
105,34 TL



TS CE

ÜRÜN KODU
001 038 140101 00 00
ÜRÜN ADI
BEGONYA NEMLİYER TAVAN
ARMATÜRÜ(YATAY) IP54
AMBALAJ ADET / KOLİ
12
FİYAT
38,44 TL



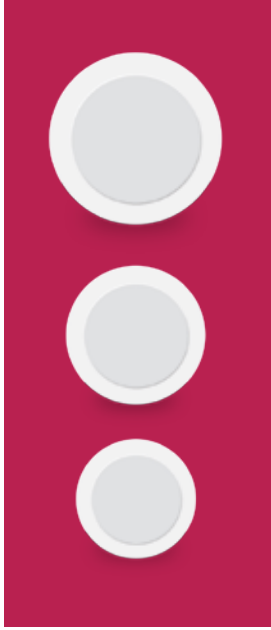

SIVA ALTI YUVARLAK SLİM LED PANELLER

Kod	Wat	Kelvin	Lümen	CRI	Arm. Ölç.(mm)	Kes. Ölç.(mm)	Kutu/Koli	Fiyat
016 242 000970	3	3000	300	>80	20x85	70	1/100	2,51 \$
016 242 000975	3	4000	300	>80	20x85	70	1/100	2,51 \$
016 242 000980	3	6000	300	>80	20x85	70	1/100	2,51 \$
016 242 000990	6	3000	600	>80	20x120	105	1/100	3,30 \$
016 242 000995	6	4000	600	>80	20x120	105	1/100	3,30 \$
016 242 001000	6	6000	600	>80	20x120	105	1/100	3,30 \$
016 242 001010	9	3000	900	>80	20x146	130	1/60	4,13 \$
016 242 001015	9	4000	900	>80	20x146	130	1/60	4,13 \$
016 242 001020	9	6000	900	>80	20x146	130	1/60	4,13 \$
016 242 001030	12	3000	1200	>80	20x170	155	1/40	5,31 \$
016 242 001035	12	4000	1200	>80	20x170	155	1/40	5,31 \$
016 242 001040	12	6000	1200	>80	20x170	155	1/40	5,31 \$
016 242 001050	15	3000	1500	>80	20x190	175	1/40	5,92 \$
016 242 001055	15	4000	1500	>80	20x190	175	1/40	5,92 \$
016 242 001060	15	6000	1500	>80	20x190	175	1/40	5,92 \$
016 242 001070	18	3000	1800	>80	20x220	205	1/20	6,49 \$
016 242 001075	18	4000	1800	>80	20x220	205	1/20	6,49 \$
016 242 001080	18	6000	1800	>80	20x220	205	1/20	6,49 \$
016 242 001090	24	3000	2400	>80	20x300	280	1/10	12,53 \$
016 242 001095	24	4000	2400	>80	20x300	280	1/10	12,53 \$
016 242 001100	24	6000	2400	>80	20x300	280	1/10	12,53 \$



SIVA ÜSTÜ YUVARLAK LED PANELLER

Kod	Wat	Kelvin	Lümen	CRI	Arm. Ölçüsü(mm)	Kutu/Koli	Fiyat
016 242 001420	6	3000	600	>80	30x120	1/60	5,18 \$
016 242 001425	6	4000	600	>80	30x120	1/60	5,18 \$
016 242 001430	6	6000	600	>80	30x120	1/60	5,18 \$
016 242 001440	12	3000	1200	>80	30x174	1/40	7,60 \$
016 242 001445	12	4000	1200	>80	30x174	1/40	7,60 \$
016 242 001450	12	6000	1200	>80	30x174	1/40	7,60 \$
016 242 001550	18	3000	1800	>80	30x220	1/20	9,99 \$
016 242 001555	18	4000	1800	>80	30x220	1/20	9,99 \$
016 242 001560	18	6000	1800	>80	30x220	1/20	9,99 \$
016 242 001170	24	3000	2400	>80	30x300	1/10	14,60 \$
016 242 001175	24	4000	2400	>80	30x300	1/10	14,60 \$
016 242 001180	24	6000	2400	>80	30x300	1/10	14,60 \$



LED PROJEKTÖRLER

Kod	Wat	Kelvin	Lümen	CRI	Kutu/Koli	Fiyat
016 302 001600	20	6000	2000	>80	1/24	8,94 \$
016 302 001630	30	6000	3000	>80	1/24	15,00 \$
016 302 001660	50	6000	5000	>80	1/12	20,22 \$
016 302 001720	100	6000	10000	>80	1/10	36,20 \$
016 302 001750	150	6000	15000	>80	1/5	56,80 \$
016 302 001780	200	6000	20000	>80	1/5	65,05 \$



T-5 LEDLİ ARMATÜRLER

Kod	Ürün Açıklaması	Kutu/Koli	Fiyat
102 038 510812	CLAT 5-8 W (25 CM)(12V)	1	71,26
102 038 508220	CLAT 5-8 W (25 CM)(220V)	1	75,29
102 038 513012	CLAT 5-13 W (31 CM)(12V)	1	55,12
102 038 513220	CLAT 5-13 W (31 CM)(220V)	1	63,19
102 038 518012	CLAT 5-18 W (51 CM)(12V)	1	53,78
102 038 518220	CLAT 5-18 W (51 CM)(220V)	1	57,81

Kod	Açıklama / Stok Cinsi	Amb. (Kutu)	Amb. Birimi	FİYAT
ETANJ ARMATÜRLER AKRİLİK CAM-PC GÖVDE (MEKANİK BALASTLI)				
066 038 910118	T-2000-04 1X18 ETANJ ARMATÜR(AKRİLİK CAM)(MEKANİK BALASTLI)	2 ad.	12	102,49
066 038 910218	T-2000-03 2X18 ETANJ ARMATÜR (AKRİLİK CAM)(MEKANİK BALASTLI)	2 ad.	12	108,19
066 038 910136	T-2000-02 1X36 ETANJ ARMATÜR (AKRİLİK CAM)(MEKANİK BALASTLI)	2 ad.	12	122,42
066 038 910236	T-2000-01 2X36 ETANJ ARMATÜR (AKRİLİK CAM)(MEKANİK BALASTLI)	2 ad.	12	148,05

ETANJ ARMATÜRLER AKRİLİK CAM-PC GÖVDE (ELEKTRONİK BALASTLI)

090 038 190136	T-2000-02 1X36 ETANJ ARMATÜR (ELEKTRONİK BALASTLI)	2 ad.	12	122,42
090 038 190236	T-2000-01 2X36 ETANJ ARMATÜR ELEKTRONİK BALASTLI)	2 ad.	12	128,12

ETANJ ARMATÜRLER PC CAM-PC GÖVDE (MEKANİK BALASTLI)

090 038 210118	TIBA-118 1X18 W ETANJ ARMATÜR PC(MEKANİK BALASTLI)	2 ad.	12	113,88
090 038 210136	TIBA-136 1X36 W ETANJ ARMATÜR PC(MEKANİK BALASTLI)	2 ad.	12	133,81
090 038 210218	TIBA-218 2X18 W ETANJ ARMATÜR PC(MEKANİK BALASTLI)	2 ad.	12	119,58
090 038 210236	TIBA-236 2X36 W ETANJ ARMATÜR PC(MEKANİK BALASTLI)	2 ad.	12	159,44

ETANJ ARMATÜRLER PC CAM-PC GÖVDE (ELEKTRONİK BALASTLI)

090 038 120118	TIBA-118 1X18 IP 65 ETANJ ARMATÜR (ELEKTRONİK BALASTLI)	2 ad.	12	113,88
090 038 120218	TIBA-218 2X18 IP 65 ETANJ ARMATÜR (ELEKTRONİK BALASTLI)	2 ad.	12	119,58
090 038 120136	TIBA-136 1X36 IP 65 ETANJ ARMATÜR (ELEKTRONİK BALASTLI)	2 ad.	12	133,81
090 038 120236	TIBA-236 2X36 IP 65 ETANJ ARMATÜR (ELEKTRONİK BALASTLI)	2 ad.	12	139,51

ETANJ ARMATÜRLER PC CAM-PC GÖVDE (OSRAM ELEKTRONİK BALASTLI)

090 038 220118	TIBA-118 1X18 W ETANJ ARMATÜR PC (OSRAM ELEKTRONİK BALASTLI)	2 ad.	12	156,59
090 038 220136	TIBA-136 1X36 W ETANJ ARMATÜR PC (OSRAM ELEKTRONİK BALASTLI)	2 ad.	12	182,21
090 038 220218	TIBA-218 2X18 W ETANJ ARMATÜR PC (OSRAM ELEKTRONİK BALASTLI)	2 ad.	12	162,28
090 038 220236	TIBA-236 2X36 W ETANJ ARMATÜR PC (OSRAM ELEKTRONİK BALASTLI)	2 ad.	12	187,91

BATTEN TMS BANT TİPİ T8 LAMBALI ARMATÜR (MEKANİK BALASTLI)

078 038 900118	1x18 W BATTEN TMS BANT TİPİ T8 LAMBALI ARM. (MEKANİK BALASTLI)	1 ad.	6	76,87
078 038 900136	1x36 W BATTEN TMS BANT TİPİ T8 LAMBALI ARM. (MEKANİK BALASTLI)	1 ad.	6	79,72
078 038 900218	2x18 W BATTEN TMS BANT TİPİ T8 LAMBALI ARM. (MEKANİK BALASTLI)	1 ad.	6	82,56
078 038 900236	2x36 W BATTEN TMS BANT TİPİ T8 LAMBALI ARM. (MEKANİK BALASTLI)	1 ad.	6	116,73

DUYLAR

040 109 040002	İTALYAN DUY E 27	50 ad.		3,23
040 109 040001	İTALYAN DUY E 14	100 ad.		2,95
040 109 040005	İTALYAN DUY RONDELASI E27	100 ad.		0,98
040 109 040003	İTALYAN DUY RONDELASI E14	100 ad.		0,88
040 109 030004	MİSFER E 27 BRONZ DUY	50 ad.		8,23
040 109 030003	MİSFER E 14 BRONZ DUY	100 ad.		7,94
024 109 010008	BAKALİT ASMA DUY	50 ad.		2,94
072 109 010001	DUVAR DUY	50 ad.		3,20
072 109 010002	TAVAN DUY	50 ad.		3,20
024 109 010004	TAVAN GLOP DİBİ	24 ad.		4,22
024 109 010003	DUVAR GLOP DİBİ	24 ad.		4,22
024 109 010005	YAĞMUR DUY (PLASTİK YANMAZ) E27	50 ad.		2,81

FLORESANT SÖKETLER

004 078 000003	TMS STARTER YUVASI (GEÇMELİ)	100 ad.		0,78
001 078 010004 00 00	FLORESANT TUTUCU AY AYAK (VİDALI TİP)	250 ad.		0,29



**KIRILMAZ
POLİKARBON
CAM ve GÖVDE**



040 109 040002

040 109 040001



040 109 030004

040 109 030003



024 109 010008



024 109 010005



024 109 010003



072 109 010001



072 109 010002



004 078 000003



001 078 010004 00 00

MUTLUSAN BAĖE ARMATÖRLERİ



ÜRÜN KODU
016 038 010116

ÜRÜN ADI
FLORA BAĖE
ARMATÖRÜ
(SİYAH)

AMB. ADET / KOLİ
1/12

FİYAT
40,48 TL



ÜRÜN KODU
016 038 010117

ÜRÜN ADI
FLORA BAĖE
ARMATÖRÜ APLİK
(SİYAH)

AMB. ADET / KOLİ
1/12

FİYAT
40,48 TL



ÜRÜN KODU
016 038 412011

ÜRÜN ADI
FLORA BAĖE
ARMATÖRÜ TAVAN
TİPİ (SİYAH)

AMB. ADET / KOLİ
1/12

FİYAT
41,67 TL



ÜRÜN KODU
016 038 412111

ÜRÜN ADI
FLORA BAĖE
ARMATÖRÜ YARIM
APLİK (SİYAH)

AMB. ADET / KOLİ
1/20

FİYAT
29,76 TL



ÜRÜN KODU
016 038 020116

ÜRÜN ADI
FLORA BAĖE
ARMATÖRÜ
(BEYAZ)

AMB. ADET / KOLİ
1/12

FİYAT
40,48 TL



ÜRÜN KODU
016 038 020117

ÜRÜN ADI
FLORA BAĖE
ARMATÖRÜ APLİK
(BEYAZ)

AMB. ADET / KOLİ
1/12

FİYAT
40,48 TL



ÜRÜN KODU
016 038 412000

ÜRÜN ADI
FLORA BAĖE
ARMATÖRÜ TAVAN
TİPİ (BEYAZ)

AMB. ADET / KOLİ
1/12

FİYAT
41,67 TL



ÜRÜN KODU
016 038 412100

ÜRÜN ADI
FLORA BAĖE
ARMATÖRÜ YARIM
APLİK (BEYAZ)

AMB. ADET / KOLİ
1/20

FİYAT
29,76 TL



ÜRÜN KODU
016 038 010120

ÜRÜN ADI
GARDEN UZUN YER
AYDINLATMA
(SİYAH)

AMB. ADET / KOLİ
1/8

FİYAT
54,98 TL

Ø151,8



ÜRÜN KODU
016 038 010118

ÜRÜN ADI
GARDEN YER
AYDINLATMA
(SİYAH)

AMB. ADET / KOLİ
1/12

FİYAT
39,48 TL

Ø152



ÜRÜN KODU
016 038 010122

ÜRÜN ADI
GARDEN DUVAR
AYDINLATMA
(SİYAH)

AMB. ADET / KOLİ
1/20

FİYAT
33,70 TL

396mm



ÜRÜN KODU
016 038 010124

ÜRÜN ADI
GARDEN APLİK
(SİYAH)

AMB. ADET / KOLİ
1/16

FİYAT
41,79 TL

251,5mm

173,5mm



ÜRÜN KODU
016 038 010121

ÜRÜN ADI
GARDEN UZUN YER
AYDINLATMA
(GRİ)

AMB. ADET / KOLİ
1/8

FİYAT
54,98 TL

Ø151,8



ÜRÜN KODU
016 038 010119

ÜRÜN ADI
GARDEN YER
AYDINLATMA
(GRİ)

AMB. ADET / KOLİ
1/12

FİYAT
39,48 TL

Ø152



ÜRÜN KODU
016 038 010123

ÜRÜN ADI
GARDEN DUVAR
AYDINLATMA
(GRİ)

AMB. ADET / KOLİ
1/20

FİYAT
33,70 TL

396mm

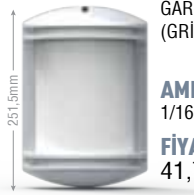

ÜRÜN KODU
016 038 010125

ÜRÜN ADI
GARDEN APLİK
(GRİ)

AMB. ADET / KOLİ
1/16

FİYAT
41,79 TL

251,5mm

173,5mm



Parklar, Bahçeler ve Kır Düğünlerinde **SU GEÇİRMEZ** Kurulumu Kolay Seyyar Aydınlatma Seti

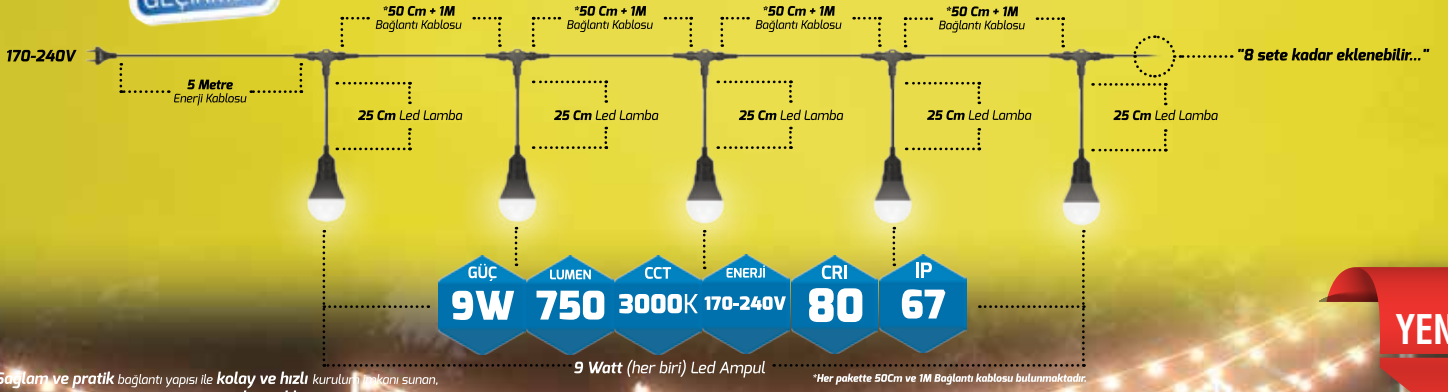

Sağlam ve pratik bağlantı yapısı ile **kolay ve hızlı** kurulumu imkanı sunan,
Olumsuz doğa koşullarına karşı son derece **dayanıklı**,
Özel tasarımı sayesinde **eklenebilir ve uzatılabilir** LED Lamba Seti.
Her türlü iç ve dış mekan aydınlatma uygulamaları için **ideal çözüm!**

9 Watt (her biri) Led Ampul

*Her pakette 50cm ve 1m Bağlantı Kablosu bulunmaktadır.

KOD	AÇIKLAMA	LUMEN	GÜÇ	IŞIK SICAKLIĞI	AMBALAJ	FİYAT
010 093 100900	9W 5'li Led Lamba Seti Dış Mekan (Su Geçirmez) (Park ve Bahçeler için Kurulumu Kolay Seyyar Aydınlatma Seti)	750 lm	9W	3000K	1 Takım	115,934 \$



010 093 100005	Power Kablo 5 MT 220V (Erkek Soketli)					8,483 \$
----------------	---	--	--	--	--	----------



010 093 100001	T Bağlantı Adaptörü					7,144 \$
----------------	---------------------	--	--	--	--	----------

9W



010 093 100901	9W Led + Ara Kablo 25cm + Erkek Konnektör Takımı	750 lm	9W	3000K		12,842 \$
----------------	--	--------	----	-------	--	-----------



010 093 100121	Duy Takımı (Ampul Hariç)					6,638 \$
----------------	--------------------------	--	--	--	--	----------



010 093 100002	Sonlandırma Tapası					0,191 \$
----------------	--------------------	--	--	--	--	----------



010 093 100000	1 Metre Ara Kablo İki Tarafı Konnektör Takılı					3,869 \$
----------------	---	--	--	--	--	----------



010 093 130416	Saha Montaj I Konnektör				10	3,721 \$
----------------	-------------------------	--	--	--	----	----------



010 093 130315	Saha Montaj T Konnektör				10	8,929 \$
----------------	-------------------------	--	--	--	----	----------



DEKORATİF LED AMPUL

Kod		Fiyat
010 093 100101	DEKORATİF LED AMPUL 7W-220V (IP 67) YEŞİL	8,929 \$
010 093 100102	DEKORATİF LED AMPUL 7W-220V (IP 67) KIRMIZI	8,929 \$
010 093 100103	DEKORATİF LED AMPUL 7W-220V (IP 67) MAVİ	8,929 \$
010 093 100104	DEKORATİF LED AMPUL 7W-220V (IP 67) AMBER	8,929 \$
010 093 100105	DEKORATİF LED AMPUL 7W-220V (IP 67) SOĞUK BEYAZ	8,929 \$
010 093 100106	DEKORATİF LED AMPUL 7W-220V (IP 67) SICAK BEYAZ	8,929 \$

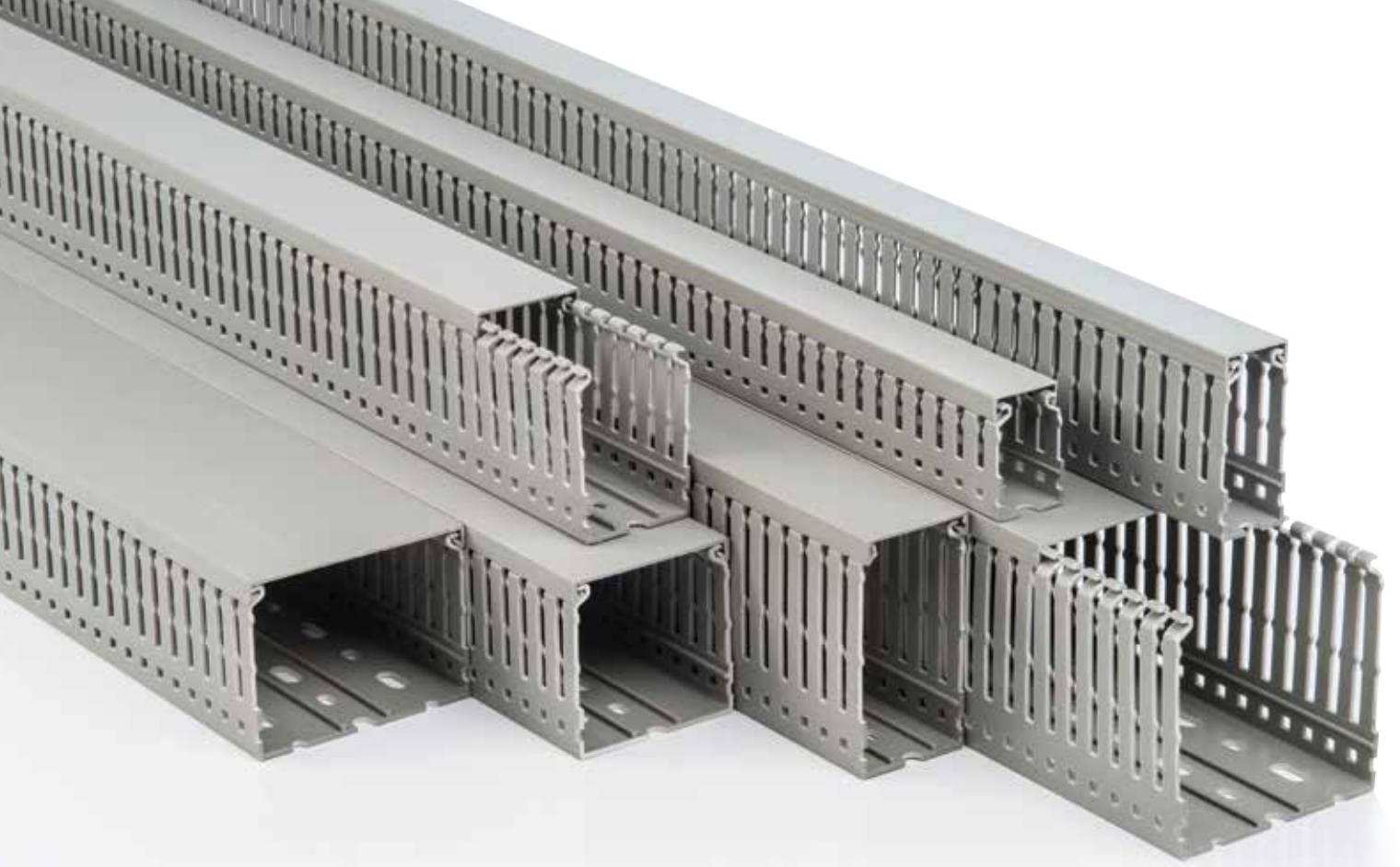

Promex

PANO TİPİ
DELİKLİ
KABLO KANALLARI

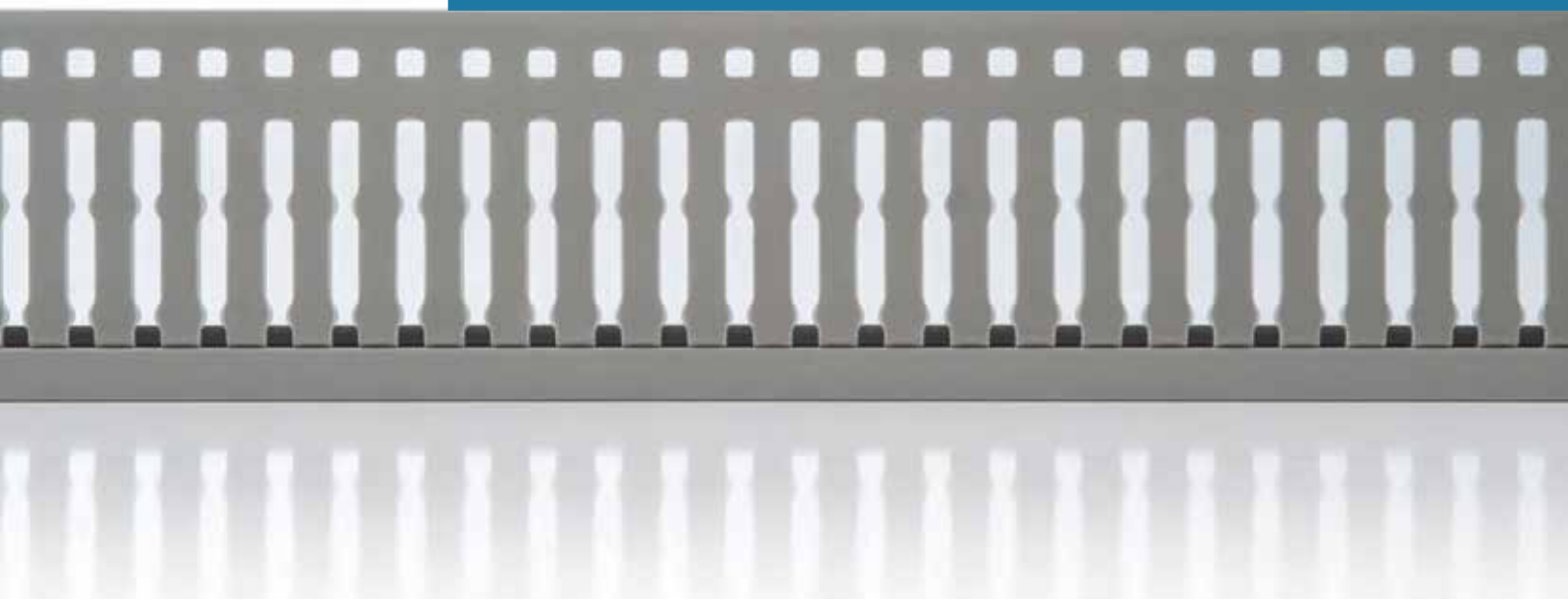



Kanal tırnakları tabanın üst noktasından, herhangi bir el aletine gereksinim duymadan 90 derecelik bükülme sonucu kolayca kırılabilir.

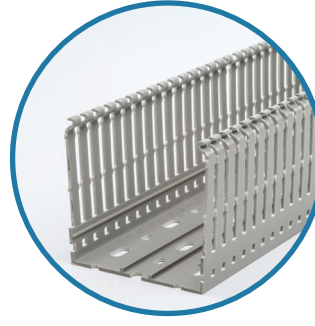

Özel tırnak tasarımı yapı ile kablolarınızı sıkıştırabilirsiniz. Kanal içindeki kabloların, kablo bağı ile bağlanmasına imkan veren delikleri sayesinde daha düzenli ve hızlı kablolama imkanına sahip olursunuz.

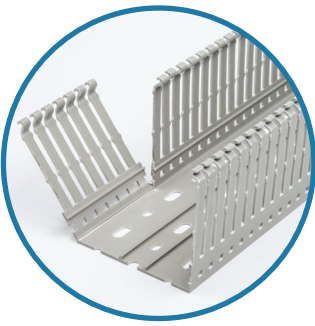

Kanal yan duvarı, kolay kırılma çizgileri sayesinde tabana sıfır olarak kırılabilir.

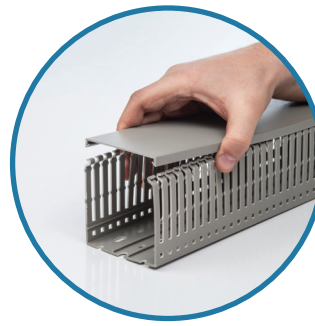

Özel kapak tasarımı, kanalın hangi konumda monte edildiğine bakılmaksızın kapağı kolayca monte etmemizi ve sökmemizi sağlar. Yoğun kablolamalarda bile kapağın kendinden çıkmasını engeller.

UL94-V0 alev iletmez özelliğe sahip PVC hammaddeden imal

Slot aralığı 4/6/4 + 5/8/5 mm genişliğinde

Taban montaj delikleri DIN 43659 standartına uygun

Standart kanal boyları 2mt

EN 5085-2-3 standartlarına uygun

Her türlü sevkiyat ve depolama koşullarına dayanıklı özel karton ambalaj

Standart renk RAL7030 Gri, istek üzerine diğer renkler üretilebilir

CE, RoHS sertifikalı

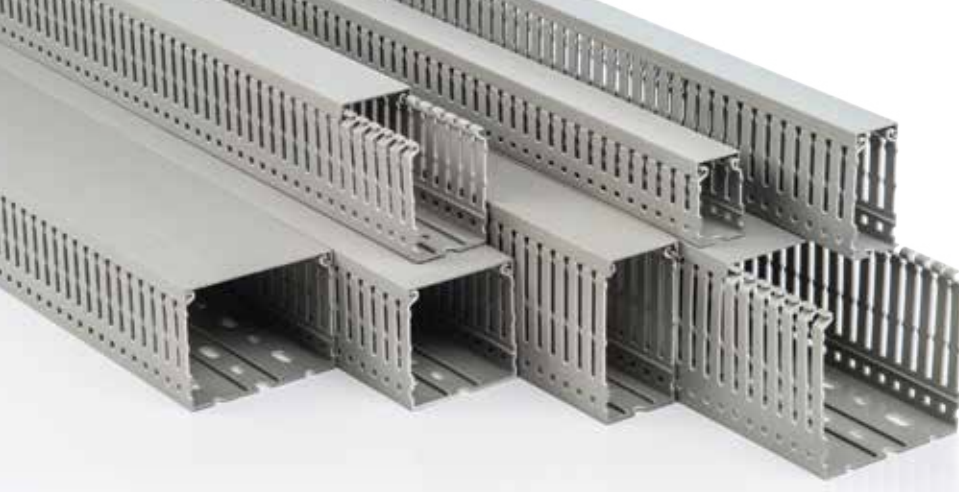

Ürün Kodu	Ürün Açıklaması	Slot Aralığı (mm)	Ambalaj/Mt.	FİYAT
-----------	-----------------	-------------------	-------------	-------

PROMEX HALOGEN FREE FLARET SERİSİ DELİKLİ KABLO KANALI



001 065 025030 20 17	25X30 PROMEX H.F. DELİKLİ KABLO KANALI	4/6/4 mm	2m. 120	44,57
001 065 025040 20 17	25X40 PROMEX H.F. DELİKLİ KABLO KANALI	4/6/4 mm	2m. 128	46,01
001 065 025060 20 17	25X60 PROMEX H.F. DELİKLİ KABLO KANALI	4/6/4 mm	2m. 96	66,51
001 065 025080 20 17	25X80 PROMEX H.F. DELİKLİ KABLO KANALI	4/6/4 mm	2m. 64	80,34
001 065 040040 20 17	40X40 PROMEX H.F. DELİKLİ KABLO KANALI	4/6/4 mm	2m. 70	59,40
001 065 040060 20 17	40X60 PROMEX H.F. DELİKLİ KABLO KANALI	4/6/4 mm	2m. 60	72,60
001 065 040080 20 17	40X80 PROMEX H.F. DELİKLİ KABLO KANALI	4/6/4 mm	2m. 40	102,06
001 065 040100 20 17	40X100 PROMEX H.F. DELİKLİ KABLO KANALI	5/8/5 mm	2m. 40	124,32
001 065 060040 20 17	60X40 PROMEX H.F. DELİKLİ KABLO KANALI	4/6/4 mm	2m. 50	78,48
001 065 060060 20 17	60X60 PROMEX H.F. DELİKLİ KABLO KANALI	4/6/4 mm	2m. 48	95,28
001 065 060080 20 17	60X80 PROMEX H.F. DELİKLİ KABLO KANALI	4/6/4 mm	2m. 32	123,84
001 065 060100 20 17	60X100 PROMEX H.F. DELİKLİ KABLO KANALI	5/8/5 mm	2m. 32	146,52
001 065 080060 20 17	80X60 PROMEX H.F. DELİKLİ KABLO KANALI	4/6/4 mm	2m. 25	118,89
001 065 080080 20 17	80X80 PROMEX H.F. DELİKLİ KABLO KANALI	4/6/4 mm	2m. 24	145,62
001 065 080100 20 17	80X100 PROMEX H.F. DELİKLİ KABLO KANALI	5/8/5 mm	2m. 24	254,01
001 065 100060 20 17	100X60 PROMEX H.F. DELİKLİ KABLO KANALI	4/6/4 mm	2m. 20	150,18
001 065 100080 20 17	100X80 PROMEX H.F. DELİKLİ KABLO KANALI	4/6/4 mm	2m. 20	181,89
001 065 100100 20 17	100X100 PROMEX H.F. DELİKLİ KABLO KANALI	5/8/5 mm	2m. 16	287,16
001 065 120060 20 17	120X60 PROMEX H.F. DELİKLİ KABLO KANALI	4/6/4 mm	2m. 20	186,00
001 065 120080 20 17	120X80 PROMEX H.F. DELİKLİ KABLO KANALI	4/6/4 mm	2m. 16	249,93

PROMEX DELİKLİ KABLO KANALI

001 105 025030 20 17	25X30 PROMEX DELİKLİ KABLO KANALI	4/6/4 mm	2m. 120	11,14
001 105 025040 20 17	25X40 PROMEX DELİKLİ KABLO KANALI	4/6/4 mm	2m. 128	11,50
001 105 025060 20 17	25X60 PROMEX DELİKLİ KABLO KANALI	4/6/4 mm	2m. 96	16,63
001 105 025080 20 17	25X80 PROMEX DELİKLİ KABLO KANALI	4/6/4 mm	2m. 64	20,09
001 105 040040 20 17	40X40 PROMEX DELİKLİ KABLO KANALI	4/6/4 mm	2m. 70	14,85
001 105 040060 20 17	40X60 PROMEX DELİKLİ KABLO KANALI	4/6/4 mm	2m. 60	18,15
001 105 040080 20 17	40X80 PROMEX DELİKLİ KABLO KANALI	4/6/4 mm	2m. 40	25,52
001 105 040100 20 17	40X100 PROMEX DELİKLİ KABLO KANALI	5/8/5 mm	2m. 40	31,08
001 105 060040 20 17	60X40 PROMEX DELİKLİ KABLO KANALI	4/6/4 mm	2m. 50	19,62
001 105 060060 20 17	60X60 PROMEX DELİKLİ KABLO KANALI	4/6/4 mm	2m. 48	23,82
001 105 060080 20 17	60X80 PROMEX DELİKLİ KABLO KANALI	4/6/4 mm	2m. 32	30,96
001 105 060100 20 17	60X100 PROMEX DELİKLİ KABLO KANALI	5/8/5 mm	2m. 32	36,63
001 105 080060 20 17	80X60 PROMEX DELİKLİ KABLO KANALI	4/6/4 mm	2m. 25	29,72
001 105 080080 20 17	80X80 PROMEX DELİKLİ KABLO KANALI	4/6/4 mm	2m. 24	36,41
001 105 080100 20 17	80X100 PROMEX DELİKLİ KABLO KANALI	5/8/5 mm	2m. 24	63,50
001 105 100060 20 17	100X60 PROMEX DELİKLİ KABLO KANALI	4/6/4 mm	2m. 20	37,55
001 105 100080 20 17	100X80 PROMEX DELİKLİ KABLO KANALI	4/6/4 mm	2m. 20	45,47
001 105 100100 20 17	100X100 PROMEX DELİKLİ KABLO KANALI	5/8/5 mm	2m. 16	71,79
001 105 120060 20 17	120X60 PROMEX DELİKLİ KABLO KANALI	4/6/4 mm	2m. 20	46,50
001 105 120080 20 17	120X80 PROMEX DELİKLİ KABLO KANALI	4/6/4 mm	2m. 16	62,48

PROMEX DELİKLİ KABLO KANALI KAPAKLARI

001 016 100025 20 17	25 LİK PROMEX KAPAK		50	6,00
001 016 100040 20 17	40 LİK PROMEX KAPAK		50	10,00
001 016 100060 20 17	60 LİK PROMEX KAPAK		50	16,00
001 016 100080 20 17	80 LİK PROMEX KAPAK		50	25,00
001 016 100100 20 17	100 LÜK PROMEX KAPAK		50	36,00
001 016 100120 20 17	120 LÜK PROMEX KAPAK		50	41,00

XX : 10 1mt. delikli kablo kanalı için.
XX : 20 2mt. delikli kablo kanalı için.

Kod	Açıklama / Stok Cinsi	Amb. (Kutu)	Amb. Birimi	FIYAT
PANO İÇİN MEKS DELİKLİ KABLO KANALLAR (GRİ)				
001 005 025025 XX 17	25X25 MEKS DELİKLİ KABLO KANALI(GRİ)	1mt. 64	2mt. 120	5,02
001 005 025040 XX 17	25X40 MEKS DELİKLİ KABLO KANALI(GRİ)	1mt. 40	2mt. 80	6,61
001 005 025060 XX 17	25X60 MEKS DELİKLİ KABLO KANALI(GRİ)	1mt. 36	2mt. 80	12,25
001 005 040040 XX 17	40X40 MEKS DELİKLİ KABLO KANALI(GRİ)	1mt. 25	2mt. 50	8,47
001 005 040060 XX 17	40X60 MEKS DELİKLİ KABLO KANALI(GRİ)	1mt. 24	2mt. 48	11,54
001 005 060040 XX 17	60X40 MEKS DELİKLİ KABLO KANALI(GRİ)	1mt. 24	2mt. 48	11,62
001 005 060060 XX 17	60X60 MEKS DELİKLİ KABLO KANALI(GRİ)	1mt. 16	2mt. 32	14,40
001 005 060080 XX 17	60X80 MEKS DELİKLİ KABLO KANALI(GRİ)	1mt. 12	2mt. 24	17,62
001 005 060100 XX 17	60X100 MEKS DELİKLİ KABLO KANALI(GRİ)	1mt. 8	2mt. 16	19,64
001 005 040080 XX 17	40X80 MEKS DELİKLİ KABLO KANALI(GRİ)	1mt. 18	2mt. 36	19,15
001 005 080060 XX 17	80X60 MEKS DELİKLİ KABLO KANALI(GRİ)	1mt. 12	2mt. 24	19,87
001 005 100060 XX 17	100X60 MEKS DELİKLİ KABLO KANALI(GRİ)	1mt. 8	2mt. 16	24,27
001 005 100100 XX 17	100X100 MEKS DELİKLİ KABLO KANALI(GRİ)	1mt. 4	2mt. 8	33,31

PANO İÇİN MEKS DELİKLİ KABLO KANALLAR (MAVİ-BEYAZ ŞERİT)

001 005 025025 XX 13	25X25 MEKS DELİKLİ KABLO KANALI(MAVİ)	1mt. 64	2mt. 120	4,92
001 005 025040 XX 13	25X40 MEKS DELİKLİ KABLO KANALI(MAVİ)	1mt. 40	2mt. 80	6,52
001 005 025060 XX 13	25X60 MEKS DELİKLİ KABLO KANALI(MAVİ)	1mt. 36	2mt. 80	11,16
001 005 040040 XX 13	40X40 MEKS DELİKLİ KABLO KANALI(MAVİ)	1mt. 25	2mt. 50	8,32
001 005 040060 XX 13	40X60 MEKS DELİKLİ KABLO KANALI(MAVİ)	1mt. 24	2mt. 48	11,17
001 005 060040 XX 13	60X40 MEKS DELİKLİ KABLO KANALI(MAVİ)	1mt. 24	2mt. 48	11,16
001 005 060060 XX 13	60X60 MEKS DELİKLİ KABLO KANALI(MAVİ)	1mt. 16	2mt. 32	13,77
001 005 060080 XX 13	60X80 MEKS DELİKLİ KABLO KANALI(MAVİ)	1mt. 12	2mt. 24	17,44
001 005 060100 XX 13	60X100 MEKS DELİKLİ KABLO KANALI(MAVİ)	1mt. 8	2mt. 16	19,00
001 005 040080 XX 13	40X80 MEKS DELİKLİ KABLO KANALI(MAVİ)	1mt. 18	2mt. 36	18,81
001 005 080060 XX 13	80X60 MEKS DELİKLİ KABLO KANALI(MAVİ)	1mt. 12	2mt. 24	20,17
001 005 100060 XX 13	100X60 MEKS DELİKLİ KABLO KANALI(MAVİ)	1mt. 8	2mt. 16	26,28
001 005 100100 XX 13	100X100 MEKS DELİKLİ KABLO KANALI(MAVİ)	1mt. 4	2mt. 8	35,49

YAPIŞKAN BANTLI MEKS DELİKLİ KABLO KANALLAR (MAVİ-BEYAZ-ŞERİT)

001 008 025025 XX 13	25X25 MM MEKS DELİKLİ KABLO KANALI(YPŞK. BANTLI)(MAVİ)	1mt. 64	2mt. 120	5,45
001 008 025040 XX 13	25X40 MM MEKS DELİKLİ KABLO KANALI(YPŞK. BANTLI)(MAVİ)	1mt. 40	2mt. 80	7,05
001 008 025060 XX 13	25X60 MM MEKS DELİKLİ KABLO KANALI(YPŞK. BANTLI)(MAVİ)	1mt. 36	2mt. 80	11,69
001 008 040040 XX 13	40X40 MM MEKS DELİKLİ KABLO KANALI(YPŞK. BANTLI)(MAVİ)	1mt. 25	2mt. 50	9,06
001 008 040060 XX 13	40X60 MM MEKS DELİKLİ KABLO KANALI(YPŞK. BANTLI)(MAVİ)	1mt. 24	2mt. 48	11,09
001 008 060040 XX 13	60X40 MM MEKS DELİKLİ KABLO KANALI(YPŞK. BANTLI)(MAVİ)	1mt. 24	2mt. 48	12,18
001 008 060060 XX 13	60X60 MM MEKS DELİKLİ KABLO KANALI(YPŞK. BANTLI)(MAVİ)	1mt. 16	2mt. 32	15,92
001 008 060080 XX 13	60X80 MM MEKS DELİKLİ KABLO KANALI(YPŞK. BANTLI)(MAVİ)	1mt. 12	2mt. 24	17,82
001 008 060100 XX 13	60X100 MM MEKS DELİKLİ KABLO KANALI(YPŞK. BANTLI)(MAVİ)	1mt. 8	2mt. 16	28,43
001 008 040080 XX 13	40X80 MM MEKS DELİKLİ KABLO KANALI(YPŞK. BANTLI)(MAVİ)	1mt. 18	2mt. 36	19,79
001 008 080060 XX 13	80X60 MM MEKS DELİKLİ KABLO KANALI(YPŞK. BANTLI)(MAVİ)	1mt. 12	2mt. 24	22,00
001 008 100060 XX 13	100X60 MM MEKS DELİKLİ KABLO KANALI(YPŞK. BANTLI)(MAVİ)	1mt. 8	2mt. 16	28,43
001 008 100100 XX 13	100X100 MM MEKS DELİKLİ KABLO KANALI(YPŞK. BANTLI)(MAVİ)	1mt. 4	2mt. 8	35,96

YAPIŞKAN BANTLI MEKS DELİKLİ KABLO KANALLAR (GRİ)

001 008 025025 XX 17	25X25 MM MEKS DELİKLİ KABLO KANALI(YPŞK. BANTLI)(GRİ)	1mt. 64	2mt. 120	5,45
001 008 025040 XX 17	25X40 MM MEKS DELİKLİ KABLO KANALI(YPŞK. BANTLI)(GRİ)	1mt. 40	2mt. 80	7,03
001 008 025060 XX 17	25X60 MM MEKS DELİKLİ KABLO KANALI(YPŞK. BANTLI)(GRİ)	1mt. 36	2mt. 80	11,68
001 008 040040 XX 17	40X40 MM MEKS DELİKLİ KABLO KANALI(YPŞK. BANTLI)(GRİ)	1mt. 25	2mt. 50	9,05
001 008 040060 XX 17	40X60 MM MEKS DELİKLİ KABLO KANALI(YPŞK. BANTLI)(GRİ)	1mt. 24	2mt. 48	11,09
001 008 060040 XX 17	60X40 MM MEKS DELİKLİ KABLO KANALI(YPŞK. BANTLI)(GRİ)	1mt. 24	2mt. 48	12,17
001 008 060060 XX 17	60X60 MM MEKS DELİKLİ KABLO KANALI(YPŞK. BANTLI)(GRİ)	1mt. 16	2mt. 32	15,91
001 008 060080 XX 17	60X80 MM MEKS DELİKLİ KABLO KANALI(YPŞK. BANTLI)(GRİ)	1mt. 12	2mt. 24	17,81
001 008 060100 XX 17	60X100 MM MEKS DELİKLİ KABLO KANALI(YPŞK. BANTLI)(GRİ)	1mt. 8	2mt. 16	24,54
001 008 040080 XX 17	40X80 MM MEKS DELİKLİ KABLO KANALI(YPŞK. BANTLI)(GRİ)	1mt. 18	2mt. 36	19,78
001 008 080060 XX 17	80X60 MM MEKS DELİKLİ KABLO KANALI(YPŞK. BANTLI)(GRİ)	1mt. 12	2mt. 24	20,47
001 008 100060 XX 17	100X60 MM MEKS DELİKLİ KABLO KANALI(YPŞK. BANTLI)(GRİ)	1mt. 8	2mt. 16	24,54
001 008 100100 XX 17	100X100 MM MEKS DELİKLİ KABLO KANALI(YPŞK. BANTLI)(GRİ)	1mt. 4	2mt. 8	34,65

KABLO TUTUCU APARATI

001 050 010001 00 00	25X40 KABLO TUTUCU APARATI		50 ad.	2,34
001 050 010002 00 00	40X40 KABLO TUTUCU APARATI		40 ad.	2,59
001 050 010003 00 00	60X40 KABLO TUTUCU APARATI		50 ad.	2,85

KABLO TUTUCU YAN APARATI

001 050 020001 00 00	40X40/60 KABLO TUTUCU YAN APARATI		100 ad.	0,84
001 050 020002 00 00	60X40/60 KABLO TUTUCU YAN APARATI		100 ad.	0,66
001 050 020003 00 00	80X60 KABLO TUTUCU YAN APARATI		100 ad.	1,16
001 050 020004 00 00	100X60 KABLO TUTUCU YAN APARATI		100 ad.	1,68

KANAL KESME MAKASI

999 999 777139	PDC110 KANAL KESME MAKASI 60MM		1 ad.	2.925,00
----------------	--------------------------------	--	-------	----------

HAREKETLİ KABLO KANALLARI

888 140 001515	15x15 MM HAREKETLİ KABLO KANALI		1 mt.	26,450 €
888 140 001825	18x25 MM HAREKETLİ KABLO KANALI		1 mt.	26,450 €
888 140 002025	20x25 MM HAREKETLİ KABLO KANALI		1 mt.	35,785 €
888 140 002040	20X40 MM HAREKETLİ KABLO KANALI		1 mt.	37,341 €
888 140 002050	20X50 MM HAREKETLİ KABLO KANALI		1 mt.	40,453 €
888 140 002540	25x40 MM HAREKETLİ KABLO KANALI		1 mt.	40,453 €
888 140 003040	30x40 MM HAREKETLİ KABLO KANALI		1 mt.	46,676 €
888 140 003041	MONTAJ AYAKLARI (1 TAKIM)		1 mt.	6,224 €

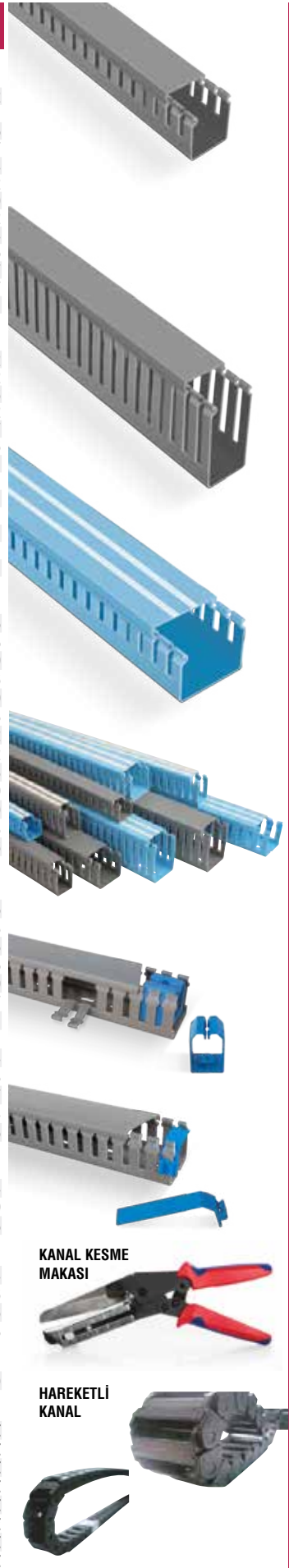

KANAL KESME MAKASI

HAREKETLİ KABLO KANAL

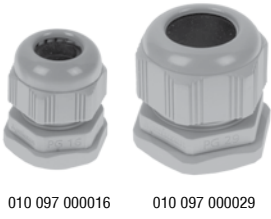

010 097 000016 010 097 000029

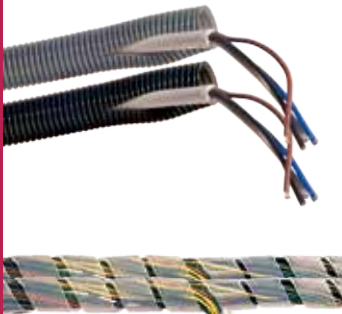

Kod	Açıklama / Stok Cinsi	Amb. (Kutu)	Amb. Birimi	FİYAT			
SÜPER ETANJ PLASTİK RAKORLAR CE							
010 097 000007	PG-7 PLASTİK RAKOR	450 ad.	4500	1,00			
010 097 000009	PG-9 PLASTİK RAKOR	300 ad.	3000	1,16			
010 097 000011	PG-11 PLASTİK RAKOR	200 ad.	2000	1,44			
010 097 000135	PG-13,5 PLASTİK RAKOR	175 ad.	1750	1,63			
010 097 000016	PG-16 PLASTİK RAKOR	125 ad.	1250	1,94			
010 097 000021	PG-21 PLASTİK RAKOR	75 ad.	750	2,81			
010 097 000029	PG-29 PLASTİK RAKOR	40 ad.	400	5,15			
010 097 000036	PG-36 PLASTİK RAKOR	20 ad.	200	9,37			
010 097 000042	PG-42 PLASTİK RAKOR	15 ad.	150	11,40			
010 097 000048	PG-48 PLASTİK RAKOR	12 ad.	120	14,06			
POLYAMİD SİRAL RAKORU							
057 097 110007	PSR-7 SİRAL RAKORU (GRI-SİYAH)	50 ad.		0,47 €			
057 097 110009	PSR-9 SİRAL RAKORU (GRI-SİYAH)	50 ad.		0,50 €			
057 097 110011	PSR-11 SİRAL RAKORU (GRI-SİYAH)	50 ad.		0,53 €			
057 097 110135	PSR-13,5 SİRAL RAKORU (GRI-SİYAH)	50 ad.		0,56 €			
057 097 110016	PSR-16 SİRAL RAKORU (GRI-SİYAH)	25 ad.		0,65 €			
057 097 110021	PSR-21 SİRAL RAKORU (GRI-SİYAH)	20 ad.		1,03 €			
057 097 110029	PSR-29 SİRAL RAKORU (GRI-SİYAH)	10 ad.		1,77 €			
057 097 110036	PSR-36 SİRAL RAKORU (GRI-SİYAH)	1 ad.		2,52 €			
057 097 110048	PSR-48 SİRAL RAKORU (GRI-SİYAH)	1 ad.		3,27 €			
POLYAMİD SİRAL DİRSEĞİ							
057 097 120007	PSRD-7 SİRAL RAKORU 90° DİRSEK (GRI-SİYAH)	1 ad.		0,87 €			
057 097 120009	PSRD-9 SİRAL RAKORU 90° DİRSEK (GRI-SİYAH)	1 ad.		0,93 €			
057 097 120011	PSRD-11 SİRAL RAKORU 90° DİRSEK (GRI-SİYAH)	1 ad.		1,03 €			
057 097 120135	PSRD-13,5 SİRAL RAKORU 90° DİRSEK (GRI-SİYAH)	1 ad.		1,21 €			
057 097 120016	PSRD-16 SİRAL RAKORU 90° DİRSEK (GRI-SİYAH)	1 ad.		1,40 €			
057 097 120021	PSRD-21 SİRAL RAKORU 90° DİRSEK (GRI-SİYAH)	1 ad.		2,24 €			
057 097 120029	PSRD-29 SİRAL RAKORU 90° DİRSEK (GRI-SİYAH)	1 ad.		2,89 €			
057 097 120036	PSRD-36 SİRAL RAKORU 90° DİRSEK (GRI-SİYAH)	1 ad.		3,92 €			
POLYAMİD SİRAL KROŞELERİ							
057 097 160007	PG-7 POLYAMİD SİRAL KROŞESİ (GRI-SİYAH)	50 ad.		0,42 €			
057 097 160009	PG-9 POLYAMİD SİRAL KROŞESİ (GRI-SİYAH)	50 ad.		0,42 €			
057 097 160011	PG-11 POLYAMİD SİRAL KROŞESİ (GRI-SİYAH)	50 ad.		0,42 €			
057 097 160135	PG-13,5 POLYAMİD SİRAL KROŞESİ (GRI-SİYAH)	50 ad.		0,45 €			
057 097 160016	PG-16 POLYAMİD SİRAL KROŞESİ (GRI-SİYAH)	50 ad.		0,48 €			
057 097 160021	PG-21 POLYAMİD SİRAL KROŞESİ (GRI-SİYAH)	25 ad.		0,54 €			
057 097 160029	PG-29 POLYAMİD SİRAL KROŞESİ (GRI-SİYAH)	25 ad.		1,01 €			
057 097 160036	PG-36 POLYAMİD SİRAL KROŞESİ (GRI-SİYAH)	25 ad.		1,55 €			
057 097 160048	PG-48 POLYAMİD SİRAL KROŞESİ (GRI-SİYAH)	10 ad.		2,14 €			
PP POLYPROPİLEN SİRALLER							
001 020 160007 00 XX	MUT/PP-7 PP SİRAL BORU	PSR7	7	10,1	100 mt.	1000	0,70
001 020 160009 00 XX	MUT/PP-8,5 PP SİRAL BORU		8,4	12,05	100 mt.	1000	0,79
001 020 160010 00 XX	MUT/PP-10 PP SİRAL BORU	PSR9	10,2	13,1	100 mt.	1000	0,88
001 020 160012 00 XX	MUT/PP-12 PP SİRAL BORU	PSR11	12,3	15,9	50 mt.	500	1,31
001 020 160014 00 XX	MUT/PP-14 PP SİRAL BORU	PSR13,5	14,1	18,35	50 mt.	500	1,75
001 020 160017 00 XX	MUT/PP-17 PP SİRAL BORU	PSR16	17	21,45	50 mt.	250	2,19
001 020 160019 00 XX	MUT/PP-19 PP SİRAL BORU		19	24,25	50 mt.	250	2,63
001 020 160023 00 XX	MUT/PP-23 PP SİRAL BORU	PSR21	23,25	28,5	50 mt.	250	2,85
001 020 160026 00 XX	MUT/PP-26 PP SİRAL BORU		26,2	31,3	25 mt.	125	3,07
001 020 160029 00 XX	MUT/PP-29 PP SİRAL BORU	PSR29	29,1	34,3	25 mt.	125	3,51
001 020 160036 00 XX	MUT/PP-36 PP SİRAL BORU	PSR36	35,8	42,2	25 mt.	125	4,82
001 020 160048 00 XX	MUT/PP-48 PP SİRAL BORU	PSR48	48,5	54,5	25 mt.	125	7,01
PA6 POLYAMİD SİRALER (A. YAYMAYAN)							
001 020 170007 00 XX	MUT/PA6-7 (A. YAYMAYAN)	PSR7	7	10,1	100 mt.	1000	1,58
001 020 170009 00 XX	MUT/PA6-8,5 (A. YAYMAYAN)		8,4	12,05	100 mt.	1000	1,75
001 020 170010 00 XX	MUT/PA6-10 (A. YAYMAYAN)	PSR9	10,2	13,1	100 mt.	1000	1,93
001 020 170012 00 XX	MUT/PA6-12 (A. YAYMAYAN)	PSR11	12,3	15,9	50 mt.	500	3,07
001 020 170014 00 XX	MUT/PA6-14 (A. YAYMAYAN)	PSR13,5	14,1	18,35	50 mt.	250	3,86
001 020 170017 00 XX	MUT/PA6-17 (A. YAYMAYAN)	PSR16	17	21,45	50 mt.	250	4,73
001 020 170019 00 XX	MUT/PA6-19 (A. YAYMAYAN)		19	24,25	50 mt.	250	5,96
001 020 170023 00 XX	MUT/PA6-23 (A. YAYMAYAN)	PSR21	23,25	28,5	50 mt.	250	6,57
001 020 170026 00 XX	MUT/PA6-26 (A. YAYMAYAN)		26,2	31,3	25 mt.	125	7,01
001 020 170029 00 XX	MUT/PA6-29 (A. YAYMAYAN)	PSR29	29,1	34,3	25 mt.	125	8,32
001 020 170036 00 XX	MUT/PA6-36 (A. YAYMAYAN)	PSR36	36,2	42,2	25 mt.	125	14,02
001 020 170048 00 XX	MUT/PA6-48 (A. YAYMAYAN)	PSR48	48,5	54,5	25 mt.	125	16,30
POLYAMİD YARIKLI SİRAL BORU(A. YAYMAYAN)							
001 020 470007 00 XX	Ø7 POLYAMİD YARIKLI SİRAL BORU(ALEV YAYMAYAN)				100 mt.	1000	1,77
001 020 470009 00 XX	Ø8,5 POLYAMİD YARIKLI SİRAL BORU(ALEV YAYMAYAN)				100 mt.	1000	1,96
001 020 470010 00 XX	Ø10 POLYAMİD YARIKLI SİRAL BORU(ALEV YAYMAYAN)				100 mt.	1000	2,16
001 020 470012 00 XX	Ø12 POLYAMİD YARIKLI SİRAL BORU(ALEV YAYMAYAN)				50 mt.	500	3,43
001 020 470014 00 XX	Ø14 POLYAMİD YARIKLI SİRAL BORU(ALEV YAYMAYAN)				50 mt.	250	4,32
001 020 470017 00 XX	Ø17 POLYAMİD YARIKLI SİRAL BORU(ALEV YAYMAYAN)				50 mt.	250	5,30
001 020 470019 00 XX	Ø19 POLYAMİD YARIKLI SİRAL BORU(ALEV YAYMAYAN)				50 mt.	250	6,67
001 020 470023 00 XX	Ø23 POLYAMİD YARIKLI SİRAL BORU(ALEV YAYMAYAN)				50 mt.	250	7,36
001 020 470026 00 XX	Ø26 POLYAMİD YARIKLI SİRAL BORU(ALEV YAYMAYAN)				25 mt.	125	7,85
001 020 470029 00 XX	Ø29 POLYAMİD YARIKLI SİRAL BORU(ALEV YAYMAYAN)				25 mt.	125	9,32
001 020 470036 00 XX	Ø36 POLYAMİD YARIKLI SİRAL BORU(ALEV YAYMAYAN)				25 mt.	125	15,70
001 020 470048 00 XX	Ø48 POLYAMİD YARIKLI SİRAL BORU(ALEV YAYMAYAN)				25 mt.	125	18,25
HELEZON PANO SİRALİ							
001 020 500001 05 00	NO.1 PANO SİRALİ (50CM)		İç Çap 5	Dış Çap 6	100 ad.	4000	0,20
001 020 500002 05 00	NO.2 PANO SİRALİ (50CM)		7	8	100 ad.	3000	0,43
001 020 500003 05 00	NO.3 PANO SİRALİ (50CM)		10	11	100 ad.	2000	0,63
001 020 500004 05 00	NO.4 PANO SİRALİ (50CM)		13	14	50 ad.	800	1,38
001 020 500005 05 00	NO.5 PANO SİRALİ (50CM)		16	17	50 ad.	800	1,44
HELEZON PANO SİRALİ(RULO)							
001 020 600001 00 00	NO.1 PANO SİRALİ (100M)		İç Çap 5	Dış Çap 6	100 mt.	500	0,40
001 020 600002 00 00	NO.2 PANO SİRALİ (100M)		7	8	100 mt.	500	0,86
001 020 600003 00 00	NO.3 PANO SİRALİ (100M)		10	11	100 mt.	500	1,27
001 020 600004 00 00	NO.4 PANO SİRALİ (100M)		13	14	50 mt.	250	2,76
001 020 600005 00 00	NO.5 PANO SİRALİ (100M)		16	17	50 mt.	250	2,88

Kod	Açıklama / Stok Cinsi	Amb. (Kutu)	Amb. Birimi	FIYAT
062 129 925100	KABLO BAĞI 2.5X100	100 ad.	40000	0,029
062 129 925150	KABLO BAĞI 2.5X150	100 ad.	20000	0,043
062 129 925200	KABLO BAĞI 2.5X200	100 ad.	15000	0,057
062 129 936150	KABLO BAĞI 3.6X150	100 ad.	10000	0,068
062 129 936200	KABLO BAĞI 3.6X200	100 ad.	10000	0,088
062 129 936250	KABLO BAĞI 3.6X250	100 ad.	10000	0,112
062 129 936300	KABLO BAĞI 3.6X300	100 ad.	10000	0,139
062 129 936370	KABLO BAĞI 3.6X370	100 ad.	10000	0,172
062 129 948200	KABLO BAĞI 4.8X200	100 ad.	10000	0,112
062 129 948250	KABLO BAĞI 4.8X250	100 ad.	10000	0,139
062 129 948300	KABLO BAĞI 4.8X300	100 ad.	10000	0,177
062 129 948380	KABLO BAĞI 4.8X380	100 ad.	5000	0,238
062 129 948400	KABLO BAĞI 4.8X400	100 ad.	5000	0,246
062 129 976300	KABLO BAĞI 7.6X300	100 ad.	3000	0,398
062 129 976380	KABLO BAĞI 7.6X380	100 ad.	2500	0,499
062 129 972450	KABLO BAĞI 7.6X450	100 ad.	3000	0,576
062 129 976550	KABLO BAĞI 7.6X550	100 ad.	2500	0,727
062 129 990750	KABLO BAĞI 9X750	100 ad.	1000	1,365
062 129 990900	KABLO BAĞI 9X900	100 ad.	1000	1,706
060 129 101919	YAPIŞKANLI KROŞE 19x19	100 ad.	10000	0,209
060 129 102828	YAPIŞKANLI KROŞE 28X28	100 ad.	4000	0,240

PEMSAN YERLİ KABLO BAĞLARI (ŞİYAH-BEYAZ)

CE

062 129 010101	EA.01.101 BONCUK KELEPÇE 2X105	1000 ad.		0,073
062 129 010102	EA.02.102 BONCUK KELEPÇE 3.5X165	500 ad.		0,157
062 129 500000	EA.04.104 BONCUK KELEPÇE 3,5X235	100 ad.		0,191
062 129 025100	EB.02.202 KABLO BAĞI 2.5X100	1000 ad.	50000	0,039
062 129 025140	EB.12.212 KABLO BAĞI 2.5X140	100 ad.	35000	0,057
062 129 025200	EB.13.213 KABLO BAĞI 2.5X200	100 ad.	30000	0,088
062 129 036150	EB.03.203 KABLO BAĞI 3.6X150	100 ad.	25000	0,085
062 129 036205	EB.04.204 KABLO BAĞI 3.6X205	100 ad.	20000	0,112
062 129 036250	EB.09.209 KABLO BAĞI 3.6X250	100 ad.	15000	0,139
062 129 036300	EB.10.210 KABLO BAĞI 3.6X300	100 ad.	15000	0,175
062 129 036370	EB.11.211 KABLO BAĞI 3.6X370	100 ad.	10000	0,218
062 129 048200	EB.14.214 KABLO BAĞI 4,8X200	100 ad.	15000	0,160
062 129 048250	EB.06.206 KABLO BAĞI 4,8X250	100 ad.	10000	0,194
062 129 048300	EB.05.205 KABLO BAĞI 4,8X300	100 ad.	10000	0,230
062 129 500001	EB.25.225 KABLO BAĞI 4,8X350	100 ad.	8000	0,262
062 129 048400	EB.16.216 KABLO BAĞI 4,8X400	100 ad.	7500	0,318
062 129 500002	EB.26.226 KABLO BAĞI 4,8X450	100 ad.	7000	0,359
062 129 008250	EB.07.207 KABLO BAĞI 8X250	100 ad.	6000	0,402
062 129 008300	EB.18.218 KABLO BAĞI 8X300	100 ad.	5000	0,424
062 129 008380	EB.19.219 KABLO BAĞI 8X380	100 ad.	5000	0,484
062 129 008450	EB.21.221 KABLO BAĞI 8X450	100 ad.	3000	0,620
062 129 008550	EB.15.215 KABLO BAĞI 8X550	100 ad.	4000	0,768
062 129 008750	EB.24.224 KABLO BAĞI 8X750	100 ad.	2000	1,307
062 129 009940	EB.22.222 KABLO BAĞI 9X940	100 ad.	1500	2,021
062 129 009762	EB.17.217 KABLO BAĞI 9X762	100 ad.	1500	1,694

KROŞE VE KLİPSLER

062 129 132020	EK.01.1001 YAPIŞKANLI KROŞE 20X20	100 ad.		0,200
062 129 132828	EK.03.1003 YAPIŞKANLI KROŞE 28X28	100 ad.		0,318
062 129 131316	EK.16.1016 YAPIŞKANLI KLİPS 13X16	100 ad.		0,231
062 129 132525	EK.05.1005 YAPIŞKANLI KLİPS 25X25	100 ad.		0,363
062 129 191325	EK.19.1019 YAPIŞKANLI KLİPS 13X25	100 ad.		0,303
062 129 142525	EK.07.1007 YAPIŞKANLI KLİPS 25X25	100 ad.		0,436
062 129 151017	EK.06.1006 VIDALI KROŞE 10X17	250 ad.		0,163
062 129 151723	EK.02.1002 VIDALI KROŞE 17X23	250 ad.		0,201
062 129 151530	EK.13.1013 VIDALI KROŞE 15X30	100 ad.		0,230
062 129 161004	EK.04.1004 DÜBELLİ KROŞE 6 DELİK İÇİN	500 ad.		0,145
062 129 171009	EK.09.1009 DUVAR KROŞESİ 6 DELİK İÇİN	250 ad.		0,200
033 129 100008	EK.17.1017 DUVAR KROŞESİ 8 DELİK İÇİN	250 ad.		0,200
062 129 171011	EK.11.1011 KANAL KROŞESİ 6 DELİK İÇİN	250 ad.		0,182
062 129 500003	EK.63.1063 KABLO KLİPSİ 6,4 (1/4")	100 ad.		0,135
062 129 500004	EK.64.1064 KABLO KLİPSİ 7,9 (5/16")	100 ad.		0,149
062 129 500005	EK.65.1065 KABLO KLİPSİ 10,9 (3/8")	100 ad.		0,168

PEMSAN BURMA TİP KELEPÇELER

060 120 005105	EA.05.105 BURMA KELEPÇE	500 ad.		0,094
060 120 007107	EA.07.107 BURMA KELEPÇE	500 ad.		0,103
060 120 010110	EA.10.110 BURMA KELEPÇE	500 ad.		0,129
060 120 014114	EA.14.114 BURMA KELEPÇE	500 ad.		0,136
060 120 017117	EA.17.117 BURMA KELEPÇE	500 ad.		0,165

ETİKETLER

062 129 111035	ET.07.907 KABLO BAĞI ETİKETİ 10X35	100 ad.		0,457
062 129 112045	ET.06.906 KABLO BAĞI ETİKETİ 20X45	100 ad.		0,726
062 129 121530	ET.02.902 YAPIŞKANLI PANO ETİKETİ 17X30	100 ad.		0,545
062 129 121750	ET.03.903 YAPIŞKANLI PANO ETİKETİ 17X50	50 ad.		0,756
062 129 122075	ET.04.904 YAPIŞKANLI PANO ETİKETİ 17X75	25 ad.		1,029



STANDART TİP

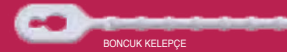

BONCUK KELEPÇE

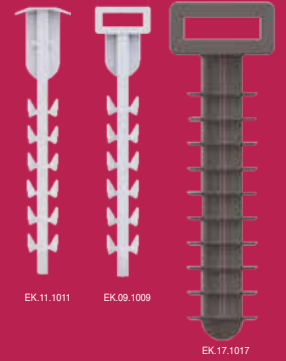



YENİ
ÜRÜNLERİMİZ

OPAK KAPAKLI ABS PANOLAR

Ürün Kodu	Ürün Ölçüleri	Ürün Cinsi	Ağırlık (Kg)	Adet	FİYAT
001 046 203013 00 17	20X30X13	PLASTİK OPAK KAPAKLI PANO	1,70	1	95,00
001 046 253515 00 17	25X35X15	PLASTİK OPAK KAPAKLI PANO	2,20	1	105,00
001 046 304017 00 17	30X40X17	PLASTİK OPAK KAPAKLI PANO	3,00	1	140,00
001 046 304022 00 17	30X40X22	PLASTİK OPAK KAPAKLI PANO	3,40	1	175,00
001 046 355019 00 17	35X50X19	PLASTİK OPAK KAPAKLI PANO	4,30	1	220,00
001 046 405018 00 17	40X50X18	PLASTİK OPAK KAPAKLI PANO	4,30	1	225,00
001 046 405024 00 17	40X50X24	PLASTİK OPAK KAPAKLI PANO	5,60	1	250,00
001 046 406020 00 17	40X60X20	PLASTİK OPAK KAPAKLI PANO	6,00	1	260,00
001 046 507025 00 17	50X70X25	PLASTİK OPAK KAPAKLI PANO	10,10	1	450,00
001 046 608026 00 17	60X80X26	PLASTİK OPAK KAPAKLI PANO	13,50	1	750,00

ŞEFFAF KAPAKLI ABS PANOLAR

Ürün Kodu	Ürün Ölçüleri	Ürün Cinsi	Ağırlık (Kg)	Adet	FİYAT
001 046 203013 00 44	20X30X13	PLASTİK ŞEFFAF KAPAKLI PANO	1,70	1	120,00
001 046 253515 00 44	25X35X15	PLASTİK ŞEFFAF KAPAKLI PANO	2,20	1	135,00
001 046 304017 00 44	30X40X17	PLASTİK ŞEFFAF KAPAKLI PANO	3,00	1	170,00
001 046 304022 00 44	30X40X22	PLASTİK ŞEFFAF KAPAKLI PANO	3,40	1	205,00
001 046 355019 00 44	35X50X19	PLASTİK ŞEFFAF KAPAKLI PANO	4,30	1	255,00
001 046 405018 00 44	40X50X18	PLASTİK ŞEFFAF KAPAKLI PANO	4,30	1	280,00
001 046 405024 00 44	40X50X24	PLASTİK ŞEFFAF KAPAKLI PANO	5,60	1	320,00
001 046 406020 00 44	40X60X20	PLASTİK ŞEFFAF KAPAKLI PANO	6,00	1	320,00
001 046 507025 00 44	50X70X25	PLASTİK ŞEFFAF KAPAKLI PANO	10,10	1	600,00
001 046 608026 00 44	60X80X26	PLASTİK ŞEFFAF KAPAKLI PANO	13,50	1	980,00

IP65 CE



YENİ
ÜRÜNLERİMİZ

OPAK KAPAKLI ABS OTOMAT PANOLAR

Ürün Kodu	Ürün Ölçüleri	Ürün Cinsi	Ağırlık (Kg)	Adet	FİYAT
001 046 253515 01 17	25X35X15	18 OTOMATLI (9X2)	2,50	1	162,00
001 046 304017 01 17	30X40X17	24 OTOMATLI (12X2)	3,40	1	206,00
001 046 355019 01 17	35X50X19	45 OTOMATLI (15X3)	4,50	1	355,00
001 046 406020 01 17	40X60X20	60 OTOMATLI (15X4)	6,00	1	363,00

IP65 CE



ŞEFFAF KAPAKLI ABS OTOMAT PANOLAR

Ürün Kodu	Ürün Ölçüleri	Ürün Cinsi	Ağırlık (Kg)	Adet	FİYAT
001 046 253515 01 44	25X35X15	18 OTOMATLI (9X2)	2,50	1	207,00
001 046 304017 01 44	30X40X17	24 OTOMATLI (12X2)	3,40	1	242,00
001 046 355019 01 44	35X50X19	45 OTOMATLI (15X3)	4,50	1	430,00
001 046 406020 01 44	40X60X20	60 OTOMATLI (15X4)	6,00	1	450,00

GALVANİZ TABAN SAÇLARI



Ürün Kodu	Ürün Ölçüleri	Ürün Kalınlığı (mm)	Adet	FİYAT
000 702 203013 00 00	20X30X13	GALVANİZ TABAN SACI 1mm	1	23,00
000 702 253515 00 00	25X35X15	GALVANİZ TABAN SACI 1mm	1	26,00
000 702 304017 00 00	30X40X17	GALVANİZ TABAN SACI 1mm	1	29,00
000 702 304022 00 00	30X40X22	GALVANİZ TABAN SACI 1mm	1	29,00
000 702 355019 00 00	35X50X19	GALVANİZ TABAN SACI 1mm	1	30,00
000 702 405018 00 00	40X50X17,5	GALVANİZ TABAN SACI 1mm	1	32,00
000 702 405024 00 00	40X50X24	GALVANİZ TABAN SACI 1mm	1	32,00
000 702 406020 00 00	40X60X20	GALVANİZ TABAN SACI 1mm	1	42,00
000 702 507025 00 00	50X70X25	GALVANİZ TABAN SACI 1mm	1	65,00

MODÜLER KİTLER ve SEPERATÖRLER



Ürün Kodu	Ürün Ölçüleri	Ürün Cinsi	Adet	FİYAT
000 700 253515 01 17	25X35X15	18 OTOMATLI (9X2)	1	26,00
000 700 304017 01 17	30X40X17	24 OTOMATLI (12X2)	1	30,00
000 700 355019 01 17	35X50X19	45 OTOMATLI (15X3)	1	48,00
000 700 406020 01 17	40X60X20	60 OTOMATLI (15X4)	1	61,00
000 700 253515 00 17	25X35X15	PLASTİK PERDE	1	1 9,00
000 700 304017 00 17	30X40X17	PLASTİK PERDE	1	26,00
000 700 355019 00 17	35X50X19	PLASTİK PERDE	1	39,00
000 700 406020 00 17	40X60X20	PLASTİK PERDE	1	42,00

PANO AKSESUARLARI



Ürün Kodu	Ürün Açıklaması	Adet	FİYAT
000 700 000700 00 17	KİLİT GÖBEK TAKIMI	1	9,80
000 700 000701 00 17	PANO DUVARA TUTURMA APARATI (4-LÜ SET)	1	13,00
000 700 000702 00 17	PLASTİK ÜÇGEN ANAHTAR	1	5,20
000 700 000703 00 17	PANO SEPERATÖRÜ TUTTURMA VİDASI	1	5,20
000 700 000704 00 17	PLASTİK KİLİTLENEBİLİR PANO KİLİDİ	1	36,00

DEVRE KESEN VE NH00 KAİDELER



Ürün Kodu	Ürün Açıklaması	Adet	FİYAT
025 110 000001	TRİFAZE DEVRE KESEN	1	80,36
025 110 000002	MONOFAZE DEVRE KESEN	2	43,90
025 110 000003	TEK KOFRA	1	135,36
025 110 000004	NH00 BOY KAİDE (KLEMENSLİ)	6	14,00
025 110 000014	NH00 BOY KAİDE (SOMUNLU)	6	14,00
025 110 000005	NH00 BOY BIÇAKLI SİGORTA (40A.-160A.)	10	15,25
025 110 000025	NH POLYESTER YER ALTI KOFRASI (KESİCİLİ)	1	342,29

PANO PRİZİ

Yeni
New



ÜRÜN KODU : 010 104 000157
ÜRÜN ADI : MRP-16 1X16 RAY TİPİ PANO PRİZİ
AMBALAJ ADET / KOLİ : 10
FİYAT : 25,75 TL



ÜRÜN KODU : 010 104 000158
ÜRÜN ADI : MRP-LED 1X16 RAY TİPİ PANO PRİZİ LEDLİ
AMBALAJ ADET / KOLİ : 10
FİYAT : 28,00 TL



ÜRÜN KODU : 010 104 000159
ÜRÜN ADI : MRP-UPS 1X16 RAY TİPİ PANO PRİZİ UPS
AMBALAJ ADET / KOLİ : 10
FİYAT : 28,00 TL

TERMOSTAT ve HİGROSTAT

Hassas kontrol sistemi ile panolarınızın ısısını güvenilir şekilde kontrol edin.

YENİ
ÜRÜNLERİMİZ

TERMOSTAT - NK



ISITMA TERMOSTAT

Ürün Kodu : 048 095 000300

Ayar Sahası : 0-60C

Kontakt Tipi : NK

Koruma Sınıfı : IP20

Ağırlık : 45gr

Koli Adedi : 135

Fiyat : 5,90 \$

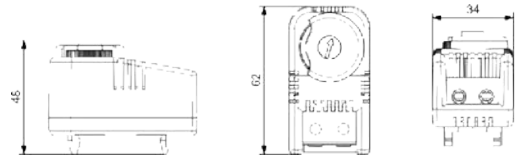

TERMOSTAT - NA



SOĞUTMA TERMOSTAT

Ürün Kodu : 048 095 000301

Ayar Sahası : 0-60C

Kontakt Tipi : NA

Koruma Sınıfı : IP20

Ağırlık : 45gr

Koli Adedi : 135

Fiyat : 5,90 \$

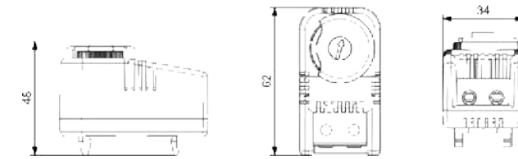

TERMOSTAT - NK+NA



DUAL TERMOSTAT

Ürün Kodu : 048 095 000302

Ayar Sahası : 0-60C / 0-60C

Kontakt Tipi : NK+NA

Koruma Sınıfı : IP20

Ağırlık : 80gr

Koli Adedi : 60

Fiyat : 11,81 \$

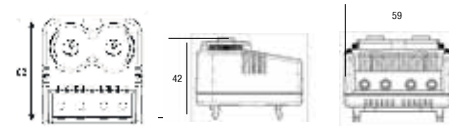

HİGROSTAT



MEKANİK HİGROSTAT

Ürün Kodu : 048 095 000303

Ayar Sahası : %10-90RH

Kontakt Tipi : 1CO

Koruma Sınıfı : IP20

Ağırlık : 180gr

Koli Adedi : 30

Fiyat : 48,61 \$



DİJİTAL TERMOSTAT ve HİGROSTAT

Hassas kontrol sistemi ile panolarınızın ısısını güvenilir şekilde kontrol edin.

YENİ
ÜRÜNLERİMİZ

PDT 50-150 SICAKLIK KONTROL CİHAZI

Ebatlar	: 36x90x65mm raya montaj
Gösterge	: 3 Hane 7 Segment
Sensör	: PTC
Ölçme Sıkalası	: -50...+150 C
Duyarlılık	: \pm C
Doğruluk	: \pm %1 (Tam Skalanın)
Kontrol Durumu	: ON-OFF
Out Çıkışı	: Röle, 250VAC, 2A, Rezistif Yük
Alarm Çıkışı	: Röle, 250VAC, 2A, Rezistif Yük
Heat set Ayarı	: LoL...UPL C (Hst)
Alarm Set Ayarı	: AtP=Abs,-Ab; LoL... C (Ast) AtP=rEL, -rL; (HSt+rAL), (HSt-20) ... (Hst+20) C
Heat Histeresiz	: 1...20 C (Hhs)
Alarm Histeresiz	: 1...20 C (Hhs)
Offset	: -20...+20 C (OFS)
Isıtma/Soğutma	: H-C; Ht(Isıtma), CL (soğutma); seçmeli
Besleme Voltaj	: 100...240VAC, 50/60 Hz
Güç Tüketimi	: <6VA
Çalışma Sıcaklığı	: -20C...55 C
İşletme İrtifası	: <2000m

Ürün Kodu : 048 095 000304
Fiyat : 104,17 \$



NOT : PTC Sensör cihaz dahilindedir.

HT-310 SICAKLIK VE NEM KONTROL CİHAZI

Ebatlar	: 35x77mm
Gösterge	: 3 Hane 7 Segment
Sensör	: Dijital Sıcaklık Nem Sensörü
Ölçme Sıkalası	: -19,9..+80,0C, 5 .. 95%RH
Duyarlılık	: \pm 0,1 C, \pm 1%RH
Doğruluk	: \pm %1 (C), \pm %3 (%RH); tam skalanın
Kontrol Durumu	: ON-OFF
C Out Çıkışı	: Röle (NA+ NK), 250VAC, 2A, Rezistif yük
%RH Out Çıkışı	: Röle, (NA), 250VAC, 2A, Rezistif Yük
Isıtma/Soğutma	: Ht (ısıtma), CL(soğutma); seçilebilir
Nem Fonksiyonu	: lo (nem alma), hi (nem verme); seçilebilir
Besleme Voltajı	: 100...220VAC, 50 / 60Hz
Güç Tüketimi	: <6VA
Çalışma Sıcaklığı	: 0...55 C
İşletme İrtifası	: <2000m

Ürün Kodu : 048 095 000305
Fiyat : 121,53 \$



NOT : Sıcaklık ve nem sensörü cihaz dahilindedir.

TEPE FANI

YENİ
ÜRÜNLERİMİZ



Ürün Kodu	Fan Tipi	Besleme	Güç	Nominal Akım	Gürültü Seviyesi	Kapasite	FİYAT
048 095 000100	Ø172x163x51 AKSİYEL	220v AC 50/60hz	25/32W	0,11/0,15A	57dB	400m3/h	69,44 \$
048 095 000101	Ø190x68 RADYAL	220v AC 50/60hz	58/75W	0,26/0,34A	62dB	560m3/h	104,17 \$
048 095 000102	Ø220x71 RADYAL	220v AC 50/60hz	85/90W	0,38/0,44A	73dB	970m3/h	121,53 \$

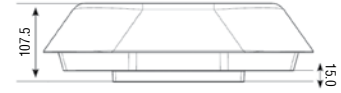
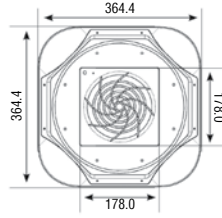

Vidasız hızlı ve kolay montaj !



Ürün Kodu	Fan Tipi	Besleme	Güç	Nominal Akım	Gürültü Seviyesi	Kapasite	FİYAT
048 095 000200	Ø172x163x51 AKSİYEL	220v AC 50/60hz	25/32W	0,11/0,15A	57dB	400m3/h	69,44 \$
048 095 000201	Ø190x68 RADYAL	220v AC 50/60hz	58/75W	0,26/0,34A	62dB	560m3/h	104,17 \$
048 095 000202	Ø220x71 RADYAL	220v AC 50/60hz	85/90W	0,38/0,44A	73dB	970m3/h	121,53 \$

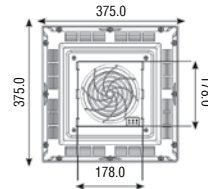

KOLAY MONTAJ FİLTRELER



Ürün Kodu:	: 048 095 000400
Ölçü (mm)	: 120x120x20.5
Kesim Ölçüsü (mm)	: 92x92
Koruma Sınıfı	: IP54
Adet	: 200
Fiyat	: 3,47 \$



Ürün Kodu:	: 048 095 000401
Ölçü (mm)	: 160x160x31
Kesim Ölçüsü (mm)	: 125x125
Koruma Sınıfı	: IP54
Adet	: 100
Fiyat	: 4,17 \$



Ürün Kodu:	: 048 095 000402
Ölçü (mm)	: 210x210x31
Kesim Ölçüsü (mm)	: 177x177
Koruma Sınıfı	: IP54
Adet	: 100
Fiyat	: 6,94 \$



Ürün Kodu:	: 048 095 000403
Ölçü (mm)	: 260x260x31
Kesim Ölçüsü (mm)	: 223x223
Koruma Sınıfı	: IP54
Adet	: 50
Fiyat	: 9,38 \$



Ürün Kodu:	: 048 095 000404
Ölçü (mm)	: 325x325x31
Kesim Ölçüsü (mm)	: 291x291
Koruma Sınıfı	: IP54
Adet	: 50
Fiyat	: 17,36 \$

PROJE CEPLERİ



Ürün Kodu	: 048 095 000902
Ürün Cinsi	: Proje Cebi A4
Adet	: 10
Fiyat	: 2,60 \$

Ürün Kodu	: 048 095 000903
Ürün Cinsi	: Proje Cebi A5
Adet	: 10
Fiyat	: 2,08 \$

FİLTRELİ FANLAR

YENİ
ÜRÜNLERİMİZ



Ürün Kodu	: 048 095 000500
Ölçü (mm)	: 120x120x58.5
Kesim Ölçüsü (mm)	: 92x92
Fan Tipi	: 80x80x38 mm
Besleme (VAC)	: 230V-50/60Hz
Güç (W)	: 14 (13)
Hız (rpm)	: 2800
Filtreli (m³/h)	: 30
Firtresiz (m³/h)	: 41
Nominal Akım (A)	: 0.08 / 0.07
Gürültü Seviyesi (db)	: 28 (31)
Fiyat	: 20,83 \$



Ürün Kodu:	: 048 095 000501
Ölçü (mm)	: 160x160x69
Kesim Ölçüsü (mm)	: 125x125
Fan Tipi	: 120x120x38 mm
Besleme (VAC)	: 230V-50/60Hz
Güç (W)	: 26 (23)
Hız (rpm)	: 2700
Filtreli (m³/h)	: 100
Firtresiz (m³/h)	: 140
Nominal Akım (A)	: 0.14 / 0.13
Gürültü Seviyesi (db)	: 42 (46)
Fiyat	: 24,31 \$



Ürün Kodu:	: 048 095 000502
Ölçü (mm)	: 120x120x58.5
Kesim Ölçüsü (mm)	: 92x92
Fan Tipi	: 80x80x38 mm
Besleme (VAC)	: 230V-50/60Hz
Güç (W)	: 14 (13)
Hız (rpm)	: 2800
Filtreli (m³/h)	: 30
Firtresiz (m³/h)	: 41
Nominal Akım (A)	: 0.08 / 0.07
Gürültü Seviyesi (db)	: 28 (31)
Fiyat	: 24,31 \$



Ürün Kodu:	: 048 095 000600
Ölçü (mm)	: 160x160x69
Kesim Ölçüsü (mm)	: 125x125
Fan Tipi	: 120x120x38 mm
Besleme (VAC)	: 230V-50/60Hz
Güç (W)	: 26 (23)
Hız (rpm)	: 2700
Filtreli (m³/h)	: 100
Firtresiz (m³/h)	: 140
Nominal Akım (A)	: 0.14 / 0.13
Gürültü Seviyesi (db)	: 42 (46)
Fiyat	: 27,78 \$



Ürün Kodu:	: 048 095 000601
Ölçü (mm)	: 210x210x98
Kesim Ölçüsü (mm)	: 177x177
Fan Tipi	: 120x120x38 mm
Besleme (VAC)	: 230V-50/60Hz
Güç (W)	: 26 (23)
Hız (rpm)	: 2700
Filtreli (m³/h)	: 125
Firtresiz (m³/h)	: 175
Nominal Akım (A)	: 0.14 / 0.13
Gürültü Seviyesi (db)	: 42 (46)
Fiyat	: 38,19 \$

FİLTRELİ FANLAR

YENİ
ÜRÜNLERİMİZ



Ürün Kodu:	: 048 095 000602
Ölçü (mm)	: 210x210x83
Kesim Ölçüsü (mm)	: 177x177
Fan Tipi	: 172x163x51mm
Besleme (VAC)	: 230V-50/60Hz
Güç (W)	: 37 (35)
Hız (rpm)	: 2400
Filtreli (m³/h)	: 175
Firtresiz (m³/h)	: 245
Nominal Akım (A)	: 0.23 / 0.22
Gürültü Seviyesi (db)	: 52 (53)
Fiyat	: 48,61 \$



Ürün Kodu:	: 048 095 000603
Ölçü (mm)	: 260x260x103
Kesim Ölçüsü (mm)	: 223x223
Fan Tipi	: 120x120x38 mm
Besleme (VAC)	: 230V-50/60Hz
Güç (W)	: 26 (23)
Hız (rpm)	: 2700
Filtreli (m³/h)	: 115
Firtresiz (m³/h)	: 130
Nominal Akım (A)	: 0.14 / 0.13
Gürültü Seviyesi (db)	: 42 (46)
Fiyat	: 41,67 \$



Ürün Kodu:	: 048 095 000604
Ölçü (mm)	: 260x260x116
Kesim Ölçüsü (mm)	: 223x223
Fan Tipi	: 172x163x51mm
Besleme (VAC)	: 230V-50/60Hz
Güç (W)	: 37 (35)
Hız (rpm)	: 2400
Filtreli (m³/h)	: 240
Firtresiz (m³/h)	: 270
Nominal Akım (A)	: 0.23 / 0.22
Gürültü Seviyesi (db)	: 52 (53)
Fiyat	: 55,56 \$



Ürün Kodu:	: 048 095 000605
Ölçü (mm)	: 260x260x111
Kesim Ölçüsü (mm)	: 223x223
Fan Tipi	: 225x225x80 mm
Besleme (VAC)	: 230V-50/60Hz
Güç (W)	: 66 (75)
Hız (rpm)	: 2600
Filtreli (m³/h)	: 650
Firtresiz (m³/h)	: 900
Nominal Akım (A)	: 0.35 / 0.38
Gürültü Seviyesi (db)	: 60 (63)
Fiyat	: 138,89 \$



Ürün Kodu:	: 048 095 000606
Ölçü (mm)	: 325x325x145
Kesim Ölçüsü (mm)	: 291x291
Fan Tipi	: 225x225x80 mm
Besleme (VAC)	: 230V-50/60Hz
Güç (W)	: 66 (75)
Hız (rpm)	: 2600
Filtreli (m³/h)	: 700
Firtresiz (m³/h)	: 950
Nominal Akım (A)	: 0.35 / 0.38
Gürültü Seviyesi (db)	: 60 (63)
Fiyat	: 149,31 \$



Ürün Kodu:	: 048 095 000607
Ölçü (mm)	: 325x325x111
Kesim Ölçüsü (mm)	: 291x291
Fan Tipi	: 280x280x80 mm
Besleme (VAC)	: 230V-50/60Hz
Güç (W)	: 110 (140)
Hız (rpm)	: 2600
Filtreli (m³/h)	: 850
Firtresiz (m³/h)	: 1200
Nominal Akım (A)	: 0.50 / 0.72
Gürültü Seviyesi (db)	: 65 (68)
Fiyat	: 156,25 \$

PANO ISITICILARI



MİNİ ISITICI

PTC ISITICI

SLİM ISITICI

YENİ
ÜRÜNLERİMİZ

Ürün Kodu	Ürün Tanımı	Besleme	Koruma Sınıfı	Ürün Ölçüsü (AxBxC)(mm)	Bağlantı	FİYAT
048 095 000700	15W PTC PANO ISITICISI	100-250V AC-DC	IP20	60x50x27	KABLO	17,36 \$
048 095 000701	25W PTC PANO ISITICISI	100-250V AC-DC	IP20	70x50x27	KABLO	20,83 \$
048 095 000702	30W PTC PANO ISITICISI	100-250V AC-DC	IP20	128x70x59	KLEMENS	26,04 \$
048 095 000703	50W PTC PANO ISITICISI	100-250V AC-DC	IP20	138x70x59	KLEMENS	31,25 \$
048 095 000704	75W PTC PANO ISITICISI	100-250V AC-DC	IP20	178x70x59	KLEMENS	48,61 \$
048 095 000705	100W PTC PANO ISITICISI	100-250V AC-DC	IP20	188x70x59	KLEMENS	52,08 \$
048 095 000706	150W PTC PANO ISITICISI	100-250V AC-DC	IP20	228x70x59	KLEMENS	59,03 \$
048 095 000707	30W SLİM PTC PANO ISITICISI	100-250V AC-DC	IP20	128x27x80	KLEMENS	24,31 \$
048 095 000708	50W SLİM PTC PANO ISITICISI	100-250V AC-DC	IP20	138x27x80	KLEMENS	27,78 \$
048 095 000709	75W SLİM PTC PANO ISITICISI	100-250V AC-DC	IP20	178x27x80	KLEMENS	45,14 \$
048 095 000710	100W SLİM PTC PANO ISITICISI	100-250V AC-DC	IP20	188x27x80	KLEMENS	48,61 \$
048 095 000711	150W SLİM PTC PANO ISITICISI	100-250V AC-DC	IP20	228x27x80	KLEMENS	55,56 \$

FANLI PANO ISITICILARI



FANLI PTC ISITICI

FANLI ISITICI

400W PLASTİK FANLI ISITICI

Ürün Kodu	Ürün Tanımı	Besleme	Koruma Sınıfı	Ürün Ölçüsü (AxBxC)(mm)	Bağlantı	FİYAT
048 095 000800	100W FANLI PTC PANO ISITICISI	230V AC 50/60 Hz	IP20	170x89x60	KLEMENS	69,44 \$
048 095 000801	150W FANLI PTC PANO ISITICISI	230V AC 50/60 Hz	IP20	210x89x60	KLEMENS	97,22 \$
048 095 000802	250W FANLI REZİSTANS PANO ISITICISI	230V AC 50/60 Hz	IP20	152x110x80	KLEMENS	104,17 \$
048 095 000803	500W FANLI REZİSTANS PANO ISITICISI	230V AC 50/60 Hz	IP20	182x110x80	KLEMENS	118,06 \$
048 095 000804	750W FANLI REZİSTANS PANO ISITICISI	230V AC 50/60 Hz	IP20	232x110x80	KLEMENS	135,42 \$
048 095 000805	200/300/400W FANLI PTC PANO ISITICISI	230V AC 50/60 Hz	IP20	99x70x67	KABLO	121,53 \$

RS-LRS SERİSİ KUTULU TİP

Ürün Kodu	Model	Güç	Vdc	Amp	Dc Ayarı	Çalışma Sıcaklığı	Boyut	Adet	FİYAT
048 091 001512	RS-15-12	15 W	12 V	0 ~ 1.3 A	10.8 ~ 13.2 V	-20° ~ +70°C	63x51x28	108	16,33 \$
048 091 001524	RS-15-24	15 W	24 V	0 ~ 0.63 A	22 ~ 27.6 V	-20° ~ +70°C	63x51x28	108	17,15 \$
048 091 002512	RS-25-12	25 W	12 V	0 ~ 2.1 A	10.8 ~ 13.2 V	-20° ~ +70°C	78x51x28	60	19,79 \$
048 091 002524	RS-25-24	26 W	24 V	0 ~ 1.1 A	22 ~ 27.6 V	-20° ~ +70°C	78x51x28	60	20,29 \$
048 091 003512	LRS-35-12	36 W	12 V	0 ~ 3 A	10.2 ~ 13.8 V	-30° ~ +70°C	99x82x30	60	25,40 \$
048 091 003524	LRS-35-24	36 W	24 V	0 ~ 1.5 A	21.6 ~ 28.8 V	-30° ~ +70°C	99x82x30	60	24,24 \$
048 091 005012	LRS-50-12	50 W	12 V	0 ~ 4.2 A	10.2 ~ 13.8 V	-30° ~ +70°C	99x82x30	60	24,24 \$
048 091 005024	LRS-50-24	53 W	24 V	0 ~ 2.2 A	21.6 ~ 28.8 V	-30° ~ +70°C	99x82x30	60	22,93 \$
048 091 007512	LRS-75-12	72 W	12 V	0 ~ 6 A	10.2 ~ 13.8 V	-30° ~ +70°C	99x97x30	45	29,19 \$
048 091 007524	LRS-75-24	77 W	24 V	0 ~ 3.2 A	21.6 ~ 28.8 V	-30° ~ +70°C	99x97x30	45	27,38 \$
048 091 010012	LRS-100-12	102 W	12 V	0 ~ 8.5 A	10.2 ~ 13.8 V	-30° ~ +70°C	129x97x30	40	32,66 \$
048 091 010024	LRS-100-24	108 W	24 V	0 ~ 4.5 A	21.6 ~ 28.8 V	-30° ~ +70°C	129x97x30	40	30,84 \$
048 091 015012	LRS-150-12	150 W	12 V	0 ~ 12.5 A	10.2 ~ 13.8 V	-30° ~ +70°C	159x97x30	30	40,57 \$
048 091 015024	LRS-150-24	156 W	24 V	0 ~ 6.5 A	21.6 ~ 28.8 V	-30° ~ +70°C	159x97x30	30	37,93 \$

HDR SERİSİ (RAY MONTAJ)

Ürün Kodu	Model	Güç	Vdc	Amp	Dc Ayarı	Çalışma Sıcaklığı	Boyut	Adet	FİYAT
048 091 201524	HDR-15-24	15 W	24 V	0.63 A	85 ~ 264 V	-30°~+70°C	17.5x90x54.5	160	25,89 \$
048 091 203024	HDR-30-24	36 W	24 V	1.5 A	85 ~ 264 V	-30°~+70°C	35x90x54.5	96	31,34 \$
048 091 206024	HDR-60-24	60 W	24 V	2.5 A	85 ~ 264 V	-30°~+70°C	52.5x90x54.5	60	42,88 \$
048 091 210024	HDR-100-24	93 W	24 V	3.83 A	85 ~ 264 V	-30°~+70°C	70x90x54.5	48	61,35 \$

EDR-NDR SERİSİ

Ürün Kodu	Model	Güç	Vdc	Amp	Dc Ayarı	Çalışma Sıcaklığı	Boyut	Adet	FİYAT
048 091 307524	EDR-75-24	75 W	24 V	3.2 A	90~264 V	-20°~+60°C	32x125x102	28	48,98 \$
048 091 312024	EDR-120-24	120 W	24 V	5.0 A	90~ 264 V	-20°~+60°C	40x125x114	20	52,45 \$
048 091 324024	NDR-240-24	240 W	24 V	10.0 A	90~264 V	-20°~+60°C	63x125x114	12	106,38 \$
048 091 348024	NDR-480-24	480 W	24 V	20.0 A	90~264 V	-20°~+60°C	86x125x129	8	236,02 \$

MDR SERİSİ

Ürün Kodu	Model	Güç	Vdc	Amp	Dc Ayarı	Çalışma Sıcaklığı	Boyut	Adet	FİYAT
048 091 101024	MDR-10-24	10 W	24 V	0.42 A	85~264 V	-20°~+70°C	23x90x100	72	26,72 \$
048 091 102424	MDR-20-24	24 W	24 V	1.0 A	85~264 V	-20°~+70°C	23x90x100	72	30,02 \$
048 091 106024	MDR-60-24	60 W	24 V	2.5 A	85~264 V	-20°~+70°C	40x90x100	42	41,56 \$
048 091 110024	MDR-100-24	96 W	24 V	4.0 A	85~264 V	-10°~+60°C	55x90x100	30	74,38 \$

TRİFAZE SERİSİ

Ürün Kodu	Model	Güç	Vdc	Amp	Verim	AC Girişi	Çalışma Sıcaklığı	Boyut	Adet	FİYAT
048 091 402424	TDR-240-24	240 W	24 V	10.0 A	92%	340~550 V	-30°~+70°C	63x125x113.5	12	187,03 \$
048 091 404824	TDR-480-24	480 W	24 V	20.0 A	PF≥90	340~550 V	-30°~+70°C	86x125x129	8	300,17 \$

SDR SERİSİ

Ürün Kodu	Model	Güç	Vdc	Amp	Verim	AC Girişi	Çalışma Sıcaklığı	Boyut	Adet	FİYAT
048 091 411224	SDR-120-24	120 W	24 V	5.0 A	PF≥93 91%	88~264 V	-25°~+70°C	40x125x114	1	131,28 \$
048 091 412424	SDR-240-24	240 W	24 V	10.0 A	PF≥93 94%	88~264 V	-25°~+70°C	63x125x114	1	220,68 \$

WDR SERİSİ (Tek Faz Ve İki Faz)

Ürün Kodu	Model	Güç	Vdc	Amp	Verim	AC Girişi	Çalışma Sıcaklığı	Boyut	Adet	FİYAT
048 091 421224	WDR-120-24	120 W	24 V	5.0 A	91%	180~550 V	-25°~+70°C	40x125x114	1	158,33 \$



LED BANT ARMATÜRLER ve BUTON SIVIÇLER (PANO İÇİN)

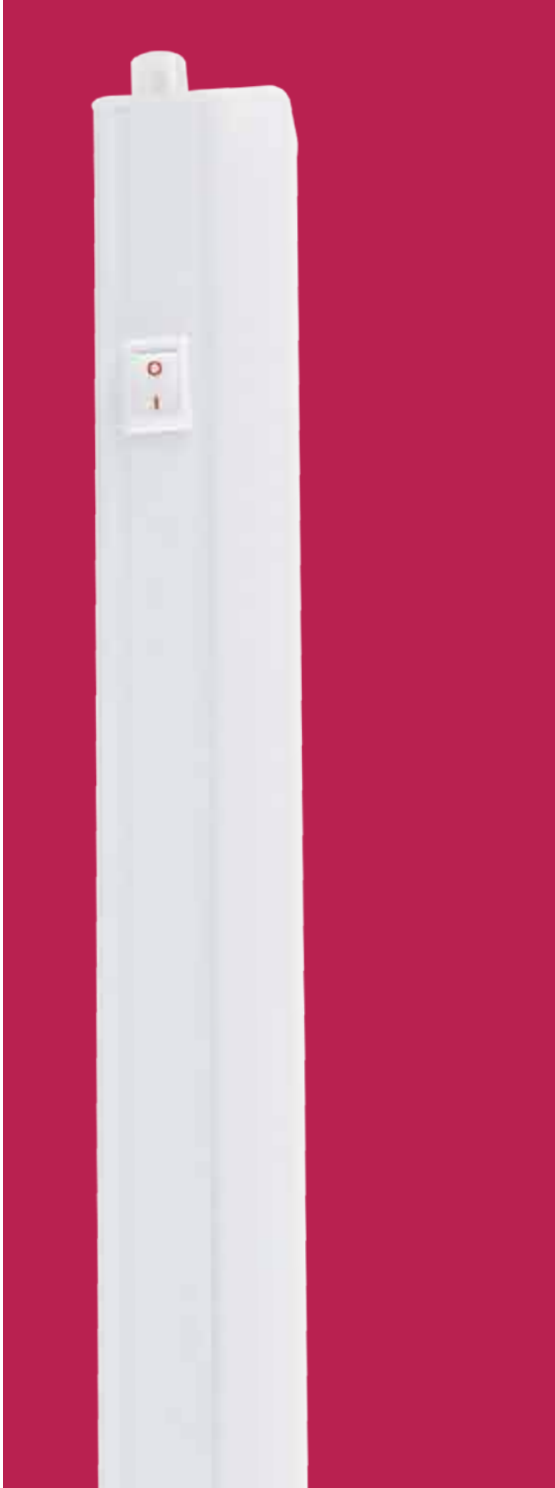

LED Bant Armatürler

CE 30.000 hr IP20

4 W	Kod	Işık Akısı	Fiyat
	016 038 702000	3000 K 360 lm	7,17 USD
	016 038 702001	6500 K 380 lm	7,17 USD

Gerilim : 220 V
Güç : 4 W
Koli Miktarı : 30 Ad.

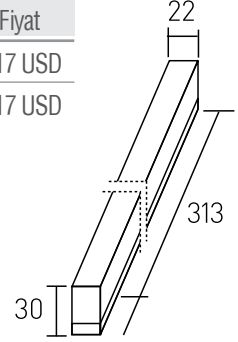

7,5 W	Kod	Renk	Işık Akısı	Fiyat
	016 038 702002	3000 K	630 lm	9,03 USD
	016 038 702003	6500 K	675 lm	9,03 USD

Gerilim : 220 V
Güç : 7,5 W
Koli Miktarı : 30 Ad.

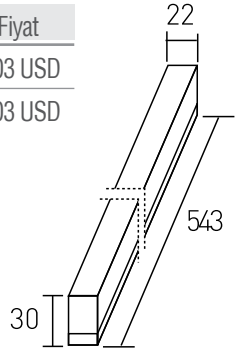

11 W	Kod	Renk	Işık Akısı	Fiyat
	016 038 702004	3000 K	950 lm	11,27 USD
	016 038 702005	6500 K	1000 lm	11,27 USD

Gerilim : 220 V
Güç : 11 W
Koli Miktarı : 30 Ad.

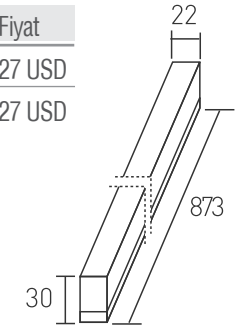

14 W	Kod	Renk	Işık Akısı	Fiyat
	016 038 702006	3000 K	1200 lm	13,32 USD
	016 038 702007	6500 K	1300 lm	13,32 USD

Gerilim : 220 V
Güç : 14 W
Koli Miktarı : 30 Ad.

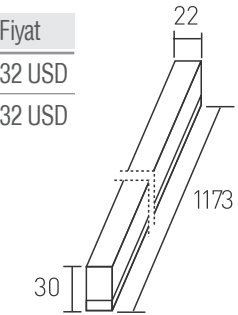

BUTON SIVIÇ

ÜRÜN KODU	ÜRÜN KODU	ÜRÜN KODU
010 104 000063	010 104 000193	010 104 000194
ÜRÜN ADI	ÜRÜN ADI	ÜRÜN ADI
MS-1010 1NO	MS-1011 1NK	MS-1012 1NA+1NK
AMBALAJ ADET / KOLİ	AMBALAJ ADET / KOLİ	AMBALAJ ADET / KOLİ
50	50	50
FİYAT	FİYAT	FİYAT
11,50 TL	11,50 TL	19,04 TL

YENİ
ÜRÜNLERİMİZ

TERMAL YAZICI VE RİBON ÇEŞİTLERİ

014 101 100501	Masaüstü, 203 dpi, Termal Transfer, Yazıcı	1	939,53 €
014 101 100502	110x300 Siyah Ribon (300 Metre) Tüm Etiketler için	1	79,72 €
014 101 100503	80x300 Siyah Ribon (300 Metre) Tüm Etiketler için	1	55,52 €
014 101 100504	55x300 Siyah Ribon (300 Metre) Tüm Etiketler için	1	37,01 €
014 101 100505	35x300 Siyah Ribon (300 Metre) Tüm Etiketler için	1	25,62 €



KALIN PANO ETİKETLERİ

014 101 100101	27X08 Kalın Pano Etiketi, Gümüş	1000	0,107 €
014 101 100102	27X08 Kalın Pano Etiketi, Beyaz	1000	0,107 €
014 101 100103	27X12 Kalın Pano Etiketi, Gümüş	1000	0,141 €
014 101 100104	27X12 Kalın Pano Etiketi, Beyaz	1000	0,141 €
014 101 100105	27X15 Kalın Pano Etiketi, Gümüş	800	0,167 €
014 101 100106	27X15 Kalın Pano Etiketi, Beyaz	800	0,167 €
014 101 100107	27X18 Kalın Pano Etiketi, Gümüş	600	0,193 €
014 101 100108	27X18 Kalın Pano Etiketi, Beyaz	600	0,193 €
014 101 100109	35X18 Kalın Pano Etiketi, Gümüş	600	0,232 €
014 101 100110	35X18 Kalın Pano Etiketi, Beyaz	600	0,232 €
014 101 100111	45X15 Kalın Pano Etiketi, Gümüş	800	0,244 €
014 101 100112	45X15 Kalın Pano Etiketi, Beyaz	800	0,244 €
014 101 100113	60X30 Kalın Pano Etiketi, Gümüş	400	0,565 €
014 101 100114	60X30 Kalın Pano Etiketi, Beyaz	400	0,565 €
014 101 100115	90X40 Kalın Pano Etiketi, Gümüş	150	1,143 €
014 101 100116	90X40 Kalın Pano Etiketi, Beyaz	150	1,143 €
014 101 100117	30X40 Kalın Pano Buton Etiketi, Gümüş (Delik Çapı 24mm)	400	0,424 €
014 101 100118	30X40 Kalın Pano Buton Etiketi, Beyaz (Delik Çapı 24mm)	400	0,424 €
014 101 100119	30X50 Kalın Pano Buton Etiketi, Gümüş (Delik Çapı 24mm)	300	0,527 €
014 101 100120	30X50 Kalın Pano Buton Etiketi, Beyaz (Delik Çapı 24mm)	300	0,527 €
014 101 100121	45X45 Kalın Pano Buton Etiketi, Gümüş (Delik Çapı 24mm)	300	0,642 €
014 101 100122	45X45 Kalın Pano Buton Etiketi, Beyaz (Delik Çapı 24mm)	300	0,642 €

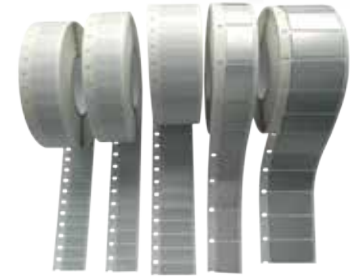

GENEL ÇOK AMAÇLI ETİKET

014 101 100201	27X12,5 Genel Amaçlı Pano Etiketi, Gümüş	2500	0,005 €
014 101 100202	27X15 Genel Amaçlı Pano Etiketi, Gümüş	2500	0,006 €
014 101 100203	27X18 Genel Amaçlı Pano Etiketi, Gümüş	2500	0,007 €
014 101 100204	35X18 Genel Amaçlı Pano Etiketi, Gümüş	2500	0,008 €
014 101 100205	45X15 Genel Amaçlı Pano Etiketi, Gümüş	2500	0,009 €
014 101 100206	70X30 Genel Amaçlı Pano Etiketi, Gümüş	250	0,025 €
014 101 100207	90X40 Genel Amaçlı Pano Etiketi	250	0,041 €



SARI ÇOK AMAÇLI ETİKET

014 101 100301	12 x 9 Sarı Çok Amaçlı Etiket	5000	0,004 €
014 101 100302	15 x 6 Sarı Çok Amaçlı Etiket	5000	0,003 €
014 101 100303	15 x 9 Sarı Çok Amaçlı Etiket	5000	0,003 €
014 101 100304	17 x 10 Sarı Çok Amaçlı Etiket	5000	0,003 €
014 101 100305	18 x 8 Sarı Çok Amaçlı Etiket	5000	0,003 €

F1 F1 F1

K8 K8

Q1-L3 Q1-L3 Q1-L3

K1 K2

ROZET İÇİNE KONAN ETİKET

014 101 100401	27X12 Sert Vinil, Rozet İçine Konan Etiket	500	0,08 €
014 101 100402	27X15 Sert Vinil, Rozet İçine Konan Etiket	500	0,08 €
014 101 100403	27X18 Sert Vinil, Rozet İçine Konan Etiket	500	0,08 €



RAY KLEMENSLER (VİDALI)

KOD	AÇIKLAMA	ADET	FİYAT
010 094 000025	2.5 MM RAY KLEMENSİ	100	2,75
010 094 000004	4 MM RAY KLEMENSİ	100	3,00
010 094 000006	6 MM RAY KLEMENSİ	100	4,62
010 094 000010	10 MM RAY KLEMENSİ	100	5,94
010 094 000016	16 MM RAY KLEMENSİ	30	10,59
010 094 000035	35 MM RAY KLEMENSİ	20	17,19
010 094 010001	KLEMENS DURDURUCU	100	2,59

RAY KLEMENSLER (TOPRAKLAMALI)

KOD	AÇIKLAMA	ADET	FİYAT
010 094 010003	2,5 MM TOPRAKLAMALI RAY KLEMENSİ	100	9,38
010 094 010008	4 MM TOPRAKLAMALI RAY KLEMENSİ	100	10,94
010 094 010004	6 MM TOPRAKLAMALI RAY KLEMENSİ	100	15,63
010 094 010009	10 MM TOPRAKLAMALI RAY KLEMENSİ	100	17,19
010 094 010005	16 MM TOPRAKLAMALI RAY KLEMENSİ	30	25,00
010 094 010010	35 MM TOPRAKLAMALI RAY KLEMENSİ	20	31,25

YAY BASKILI RAY KLEMENSLER

KOD	AÇIKLAMA	ADET	FİYAT
010 094 010011	2.5 MM RAY KLEMENS (YAY BASKILI)	100	2,81
010 094 010012	4 MM RAY KLEMENS (YAY BASKILI)	100	3,13
010 094 010013	6 MM RAY KLEMENS (YAY BASKILI)	100	5,10
010 094 010014	10 MM RAY KLEMENS (YAY BASKILI)	100	6,56

SİGORTALI RAY KLEMENSLER

KOD	AÇIKLAMA	ADET	FİYAT
010 094 000051	SİGORTALI RAY KLEMENS	75 ad.	17,19

DEKAFİX

KOD	AÇIKLAMA	ADET	FİYAT
010 094 010006	YAZILI DEKAFİX (1 ADET FİYATI)	500	0,16
010 094 010007	YAZISIZ DEKAFİX (1 ADET FİYATI)	500	0,12

PANO TOPRAKLAMA KLEMENSLERİ (6X8mm kesit 63 AMP.)

KOD	AÇIKLAMA	L	B	H	ADET	FİYAT
014 102 006304	4 DELİK PANO TOPRAKLAMA KLEMENS	6	8	33	1500	2,35
014 102 006305	5 DELİK PANO TOPRAKLAMA KLEMENS	6	8	38	1500	2,51
014 102 006306	6 DELİK PANO TOPRAKLAMA KLEMENS	6	8	45	1250	3,29
014 102 006307	7 DELİK PANO TOPRAKLAMA KLEMENS	6	8	50	1000	3,44
014 102 006309	9 DELİK PANO TOPRAKLAMA KLEMENS	6	8	62	1000	3,76
014 102 006310	10 DELİK PANO TOPRAKLAMA KLEMENS	6	8	68	750	4,07
014 102 006312	12 DELİK PANO TOPRAKLAMA KLEMENS	6	8	80	750	4,93

PANO TOPRAKLAMA KLEMENSLERİ AYAKLI (6,5X9mm kesit 80 amp.)

KOD	AÇIKLAMA	L	B	H	ADET	FİYAT
014 102 008006	6 DELİK AYAKLI DAĞITIM ÜNİTESİ	85	70	22	200	6,03
014 102 008010	10 DELİK AYAKLI DAĞITIM ÜNİTESİ	108	95	22	150	7,75
014 102 008012	12 DELİK AYAKLI DAĞITIM ÜNİTESİ	120	106	22	150	8,61
014 102 008015	15 DELİK AYAKLI DAĞITIM ÜNİTESİ	138	124	22	125	10,41
014 102 008020	20 DELİK AYAKLI DAĞITIM ÜNİTESİ	165	152	22	100	13,54

125 A. 1 KUTUP DAĞITIM ÜNİTESİ

KOD	AÇIKLAMA	CİNS	L	B	H	ADET	FİYAT
014 102 112507	125 A. 1 KUTUP DAĞITIM ÜNİTESİ	2+5	76	44	42	70	13,01
014 102 112510	125 A. 1 KUTUP DAĞITIM ÜNİTESİ	2+8	100	44	42	60	15,53
014 102 112512	125 A. 1 KUTUP DAĞITIM ÜNİTESİ	2+10	115	44	42	55	18,19
014 102 112515	125 A. 1 KUTUP DAĞITIM ÜNİTESİ	2+13	135	44	42	45	20,70
014 102 112520	125 A. 1 KUTUP DAĞITIM ÜNİTESİ	2+18	170	44	42	35	28,99
014 102 112522	125 A. 1 KUTUP DAĞITIM ÜNİTESİ	2+20	185	44	42	30	32,10

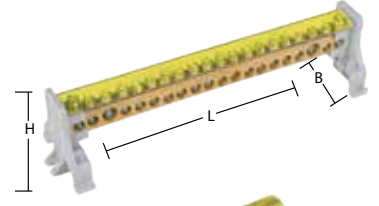

125 A. 2 KUTUP DAĞITIM ÜNİTESİ

KOD	AÇIKLAMA	CİNS	L	B	H	ADET	FİYAT
014 102 212507	125 A. 2 KUTUP DAĞITIM ÜNİTESİ	2+5	81	90	50	20	27,14
014 102 212510	125 A. 2 KUTUP DAĞITIM ÜNİTESİ	2+8	103	90	50	16	30,47
014 102 212512	125 A. 2 KUTUP DAĞITIM ÜNİTESİ	2+10	118	90	50	12	33,57
014 102 212515	125 A. 2 KUTUP DAĞITIM ÜNİTESİ	2+13	142	90	50	10	44,00
014 102 212520	125 A. 2 KUTUP DAĞITIM ÜNİTESİ	2+18	178	90	50	8	56,57

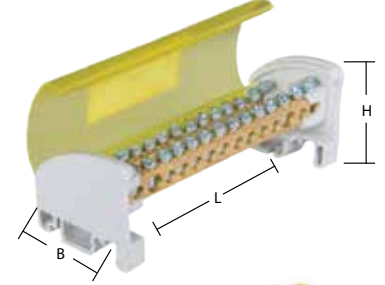

125 A. 4 KUTUP DAĞITIM ÜNİTESİ

KOD	AÇIKLAMA	CİNS	L	B	H	ADET	FİYAT
014 102 412507	125 A. 4 KUTUP DAĞITIM ÜNİTESİ	2+5	60	80	75	10	54,50
014 102 412510	125 A. 4 KUTUP DAĞITIM ÜNİTESİ	2+8	83	80	75	8	57,68
014 102 412512	125 A. 4 KUTUP DAĞITIM ÜNİTESİ	2+10	97	80	75	6	65,96
014 102 412515	125 A. 4 KUTUP DAĞITIM ÜNİTESİ	2+13	120	80	75	5	80,75
014 102 412520	125 A. 4 KUTUP DAĞITIM ÜNİTESİ	2+18	155	80	75	4	105,89
014 102 412522	125 A. 4 KUTUP DAĞITIM ÜNİTESİ	2+20	170	80	75	4	113,36
014 102 412525	125 A. 4 KUTUP DAĞITIM ÜNİTESİ	2+23	191	80	75	4	131,99

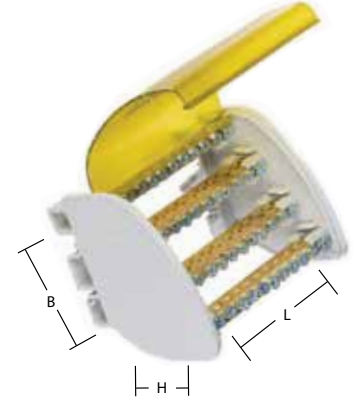

3 KUTUP 10X15 KESİT 160 AMP. DAĞITICI ÜNİTELER

KOD	AÇIKLAMA	CİNS	L	B	H	ADET	FİYAT
014 102 316007	160 A. 3 KUTUP DAĞITIM ÜNİTESİ	2+5	105	130	55	12	94,34
014 102 316010	160 A. 3 KUTUP DAĞITIM ÜNİTESİ	2+8	145	130	55	8	137,56
014 102 316012	160 A. 3 KUTUP DAĞITIM ÜNİTESİ	2+10	165	130	55	8	165,98
014 102 316015	160 A. 3 KUTUP DAĞITIM ÜNİTESİ	2+13	200	130	55	6	203,56
014 102 316020	160 A. 3 KUTUP DAĞITIM ÜNİTESİ	2+18	255	130	55	4	277,16
014 102 316022	160 A. 3 KUTUP DAĞITIM ÜNİTESİ	2+20	275	130	55	4	305,35

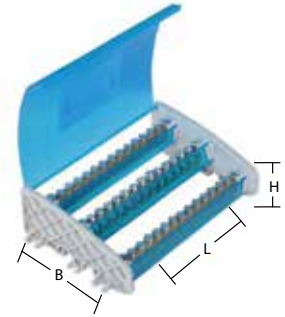

4 KUTUP 10X15 KESİT 160 AMP. DAĞITICI ÜNİTELER

KOD	AÇIKLAMA	CİNS	L	B	H	ADET	FİYAT
014 102 416007	160 A. 4 KUTUP DAĞITIM ÜNİTESİ	2+5	105	144	55	12	106,48
014 102 416010	160 A. 4 KUTUP DAĞITIM ÜNİTESİ	2+8	145	144	55	8	155,02
014 102 416012	160 A. 4 KUTUP DAĞITIM ÜNİTESİ	2+10	165	144	55	8	184,15
014 102 416015	160 A. 4 KUTUP DAĞITIM ÜNİTESİ	2+13	200	144	55	6	228,62
014 102 416020	160 A. 4 KUTUP DAĞITIM ÜNİTESİ	2+18	255	144	55	4	305,35
014 102 416022	160 A. 4 KUTUP DAĞITIM ÜNİTESİ	2+20	275	144	55	4	310,04

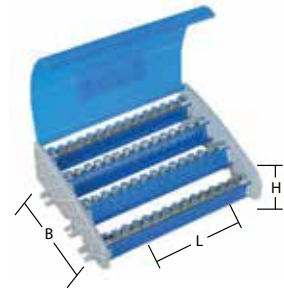

5 KUTUP 10X15 KESİT 160 AMP. DAĞITICI ÜNİTELER

KOD	AÇIKLAMA	CİNS	L	B	H	ADET	FİYAT
014 102 516007	160 A. 5 KUTUP DAĞITIM ÜNİTESİ	2+5	105	151	95	8	127,62
014 102 516010	160 A. 5 KUTUP DAĞITIM ÜNİTESİ	2+8	145	151	95	4	183,99
014 102 516012	160 A. 5 KUTUP DAĞITIM ÜNİTESİ	2+10	165	151	95	4	219,22
014 102 516015	160 A. 5 KUTUP DAĞITIM ÜNİTESİ	2+13	200	151	95	4	274,03
014 102 516020	160 A. 5 KUTUP DAĞITIM ÜNİTESİ	2+18	255	151	95	4	366,42
014 102 516022	160 A. 5 KUTUP DAĞITIM ÜNİTESİ	2+20	275	151	95	4	399,30

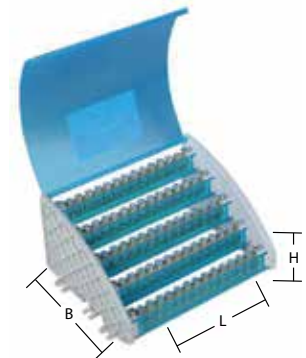

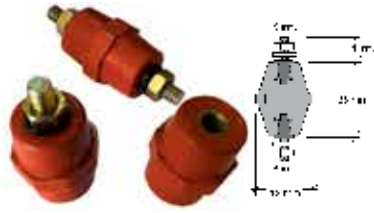

MİNİ BOY MESNET İZOLATÖRLERİ

KOD	AÇIKLAMA	ADET	FİYAT
049 123 010001	BMI-M 5/2C MİNİ İZOLATÖR	300 ad.	2,15
049 123 010002	BMI-M 5/1C+1S MİNİ İZOLATÖR	300 ad.	2,48
049 123 010003	BMI-M 5/2S MİNİ İZOLATÖR	300 ad.	2,82



ORTA BOY KONİK MESNET İZOLATÖRLERİ

KOD	AÇIKLAMA	ADET	FİYAT
049 123 020001	BMI-M 6/2C ORTA KONİK İZOLATÖR	100 ad.	3,16
049 123 020002	BMI-M 6/1C+1S ORTA KONİK İZOLATÖR	100 ad.	3,61
049 123 020003	BMI-M 6/2S ORTA KONİK İZOLATÖR	100 ad.	3,95

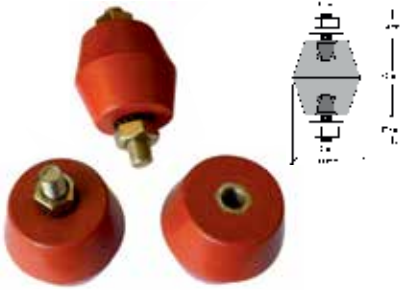

BÜYÜK BOY MESNET İZOLATÖRLERİ

KOD	AÇIKLAMA	ADET	FİYAT
049 123 030001	BMI-M 8/2C BÜYÜK BOY KONİK İZOLATÖR	40 ad.	4,52
049 123 030002	BMI-M 8/1C+1S BÜYÜK BOY KONİK İZOLATÖR	40 ad.	4,89
049 123 030003	BMI-M 8/2S BÜYÜK BOY KONİK İZOLATÖR	40 ad.	5,38
049 123 030004	BMI-M 10/2C BÜYÜK BOY KONİK İZOLATÖR	40 ad.	6,78
049 123 030005	BMI-M 10/1C+1S BÜYÜK BOY KONİK İZOLATÖR	40 ad.	7,00
049 123 030006	BMI-M 10/2S BÜYÜK BOY KONİK İZOLATÖR	40 ad.	7,80



EŞ POTANSİYEL BARALAR (İZOLATÖR AYAKLI)

KOD	AÇIKLAMA	ADET	FİYAT
049 123 060001	1-GİRİŞ 7-ÇIKIŞ EŞ POTANSİYEL BARA	100 ad.	69,35
049 123 060002	1-GİRİŞ 10-ÇIKIŞ EŞ POTANSİYEL BARA	75 ad.	87,81
049 123 060003	1-GİRİŞ 14-ÇIKIŞ EŞ POTANSİYEL BARA	50 ad.	119,06



BARA TUTUCU

KOD	AÇIKLAMA	ADET	FİYAT
049 123 050001	BMS (M8) BARA TUTUCU	50 ad.	6,45

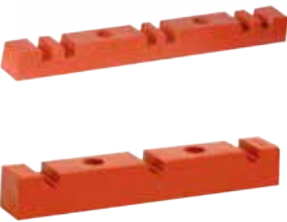

TARAK İZOLATÖRLER

KOD	AÇIKLAMA	ADET	FİYAT
049 123 040001	3X1 F TARAK İZOLATÖR (2ADET TAKIM)	20 tkm.	14,91
049 123 040002	3X2 F TARAK İZOLATÖR (2ADET TAKIM)	20 tkm.	20,78
049 123 040003	3X1 F+N TARAK İZOLATÖR (2ADET TAKIM)	20 tkm.	22,13
049 123 040005	3X2 F+N TARAK İZOLATÖR (2ADET TAKIM)	4 tkm.	29,36

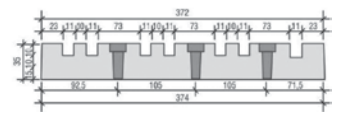
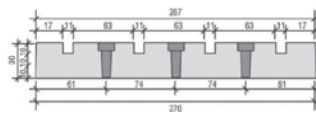
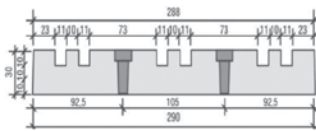
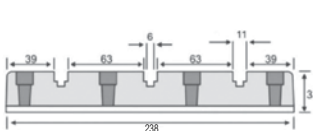

TOPRAKLAMA BARASI ve MESNEDİ

KOD	AÇIKLAMA	ADET	FİYAT
034 025 040001	TOPRAKLAMA BARASI 1 mt. (1mm)	50 ad.	40,93
034 025 100001	TOPRAKLAMA BARASI MESNEDİ	40 ad.	0,84

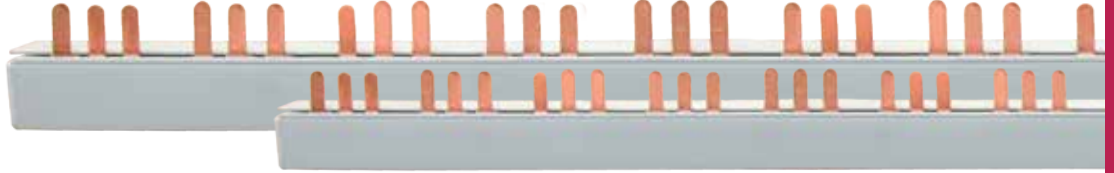

TRİFAZE BARALAR

KOD	AÇIKLAMA	ADET	FİYAT
034 025 040004	TRİFAZE MÜŞTEREK BARA İĞNE UÇLU 53 CM	24 ad.	40,76
034 025 040006	TRİFAZE MÜŞTEREK BARA İĞNE UÇLU 106 CM	24 ad.	81,52



MONOFAZE BARA

KOD	AÇIKLAMA	ADET	FİYAT
034 025 040002	MONOFAZE MÜŞTEREK BARA İĞNE UÇLU 106 CM	50 ad.	29,52

BORU GEÇME TOPRAKLAMA ÇUBUĞU

KOD	AÇIKLAMA	ADET	FİYAT
091 025 011610	TOP ÇUBUĞU BORU GEÇMELİ 16 MM 1 MT	10 ad.	102,18
091 025 011615	TOP ÇUBUĞU BORU GEÇMELİ 16 MM 1,5 MT	10 ad.	106,88
091 025 012010	TOP ÇUBUĞU BORU GEÇMELİ 20 MM 1 MT	5 ad.	150,58
091 025 012015	TOP ÇUBUĞU BORU GEÇMELİ 20 MM 1,5 MT	5 ad.	161,33

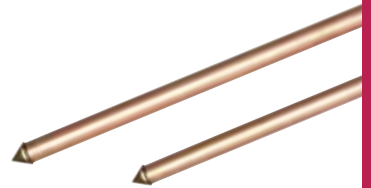

RAYLAR

KOD	AÇIKLAMA	ADET	FİYAT
001 025 020100 00 00	KLEMENS RAYI(1M)	25 mt.	12,45
001 025 000100 00 00	W OTOMAT RAYI(1M)	50 mt.	6,25
001 025 000033 00 00	W OTOMAT RAYI(33CM)	50 ad.	2,09
001 025 900100 00 00	W OTOMAT RAYI(DELİKLİ)(1M)	50 mt.	5,94

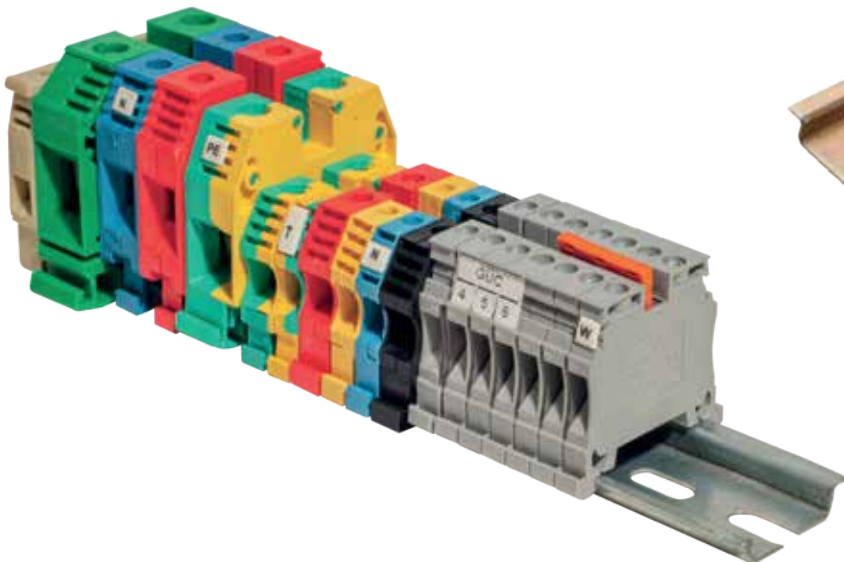
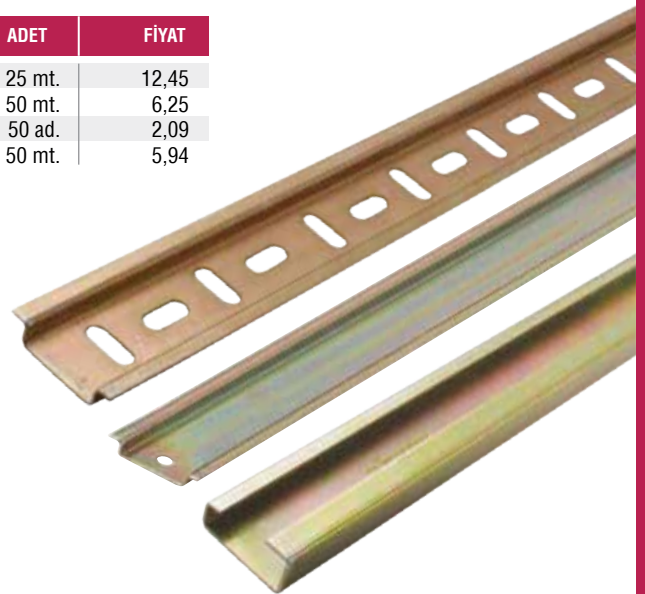



Kod	Açıklama / Stok Cinsi	Amb. (Kutu)	Amb. Birimi	FİYAT
İZOLELİ TEK GİRİŞLİ YÜKSÜK				
014 100 010508	ITY-0508 İZO.TEK GİRİŞ. YÜKSÜK 0,50 MM	1000 ad.		0,046
014 100 017508	ITY-7508 İZO.TEK GİRİŞ. YÜKSÜK 0,75 MM	1000 ad.		0,046
014 100 011008	ITY-1008 İZO.TEK GİRİŞ. YÜKSÜK 1,00 MM	1000 ad.		0,046
014 100 011508	ITY-1508 İZO.TEK GİRİŞ. YÜKSÜK 1,50 MM	1000 ad.		0,052
014 100 012508	ITY-2508 İZO.TEK GİRİŞ. YÜKSÜK 2,50 MM	500 ad.		0,065
014 100 014009	ITY-4009 İZO.TEK GİRİŞ. YÜKSÜK 4,00 MM	500 ad.		0,113
014 100 016012	ITY-6012 İZO.TEK GİRİŞ. YÜKSÜK 6,00 MM	250 ad.		0,148
014 100 011012	ITY-1012 İZO.TEK GİRİŞ. YÜKSÜK 10,00 MM	100 ad.		0,188
014 100 011612	ITY-1612 İZO.TEK GİRİŞ. YÜKSÜK 16,00 MM	100 ad.		0,269
014 100 012516	ITY-2516 İZO.TEK GİRİŞ. YÜKSÜK 25,00 MM	50 ad.		0,524
014 100 013516	ITY-3516 İZO.TEK GİRİŞ. YÜKSÜK 35,00 MM	50 ad.		0,632
014 100 015020	ITY-5020 İZO.TEK GİRİŞ. YÜKSÜK 50,00 MM	25 ad.		1,210
İZOLELİ ÇİFT GİRİŞLİ YÜKSÜK				
014 100 020508	ICY-0508 İZO.ÇİFT GİRİŞ. YÜKSÜK 2X0,5 MM	1000 ad.		0,090
014 100 027508	ICY-7508 İZO.ÇİFT GİRİŞ. YÜKSÜK 2X0,75MM	500 ad.		0,090
014 100 021008	ICY-1008 İZO.ÇİFT GİRİŞ. YÜKSÜK 2X1 MM	500 ad.		0,101
014 100 021508	ICY-1508 İZO.ÇİFT GİRİŞ. YÜKSÜK 2X1,5 MM	500 ad.		0,121
014 100 022510	ICY-2510 İZO.ÇİFT GİRİŞ. YÜKSÜK 2X2,5 MM	250 ad.		0,177
014 100 024012	ICY-4012 İZO.ÇİFT GİRİŞ. YÜKSÜK 2X4 MM	200 ad.		0,229
014 100 026014	ICY-6014 İZO.ÇİFT GİRİŞ. YÜKSÜK 2X6 MM	100 ad.		0,309
İZOLELİ YUVARLAK TİP PAPUÇ				
014 100 030154	IYP-1,5-4 İZO.YUV.TİP PAP. 0,5-1,5MM(M4)	200 ad.		0,208
014 100 030155	IYP-1,5-5 İZO.YUV.TİP PAP. 0,5-1,5MM(M5)	200 ad.		0,215
014 100 030156	IYP-1,5-6 İZO.YUV.TİP PAP. 0,5-1,5MM(M6)	200 ad.		0,336
014 100 030158	IYP-1,5-8 İZO.YUV.TİP PAP. 0,5-1,5MM(M8)	200 ad.		0,350
014 100 030254	IYP-2,5-4 İZO.YUV.TİP PAP. 1,5-2,5MM(M4)	200 ad.		0,262
014 100 030255	IYP-2,5-5 İZO.YUV.TİP PAP. 1,5-2,5MM(M5)	200 ad.		0,269
014 100 030256	IYP-2,5-6 İZO.YUV.TİP PAP. 1,5-2,5MM(M6)	200 ad.		0,370
014 100 030258	IYP-2,5-8 İZO.YUV.TİP PAP. 1,5-2,5MM(M8)	200 ad.		0,376
014 100 036004	IYP-6-4 İZO.YUV.TİP PAP. 4-6MM(M4)	100 ad.		0,538
014 100 036005	IYP-6-5 İZO.YUV.TİP PAP. 4-6 MM(M5)	100 ad.		0,551
014 100 036006	IYP-6-6 İZO.YUV.TİP PAP. 4-6MM(M6)	100 ad.		0,618
014 100 036008	IYP-6-8 İZO.YUV.TİP PAP. 4-6MM(M8)	100 ad.		0,807
İZOLELİ ÇATAL TİP PAPUÇ				
014 100 040154	ICP-1,5-4 İZO.ÇTL.TİP PAP. 0,5-1,5MM(M4)	200 ad.		0,188
014 100 040155	ICP-1,5-5 İZO.ÇTL.TİP PAP. 0,5-1,5MM(M5)	200 ad.		0,215
014 100 040156	ICP-1,5-6 İZO.ÇTL.TİP PAP. 0,5-1,5MM(M6)	200 ad.		0,235
014 100 040254	ICP-2,5-4 İZO.ÇTL.TİP PAP. 0,5-1,5MM(M4)	200 ad.		0,222
014 100 040255	ICP-2,5-5 İZO.ÇTL.TİP PAP. 0,5-1,5MM(M5)	200 ad.		0,229
014 100 040256	ICP-2,5-6 İZO.ÇTL.TİP PAP. 0,5-1,5MM(M6)	200 ad.		0,296
014 100 046004	ICP-6-4 İZO.ÇTL.TİP PAP. 4-6 MM(M4)	100 ad.		0,471
014 100 046005	ICP-6-5 İZO.ÇTL.TİP PAP. 4-6 MM(M5)	100 ad.		0,484
014 100 046006	ICP-6-6 İZO.ÇTL.TİP PAP. 4-6 MM(M6)	100 ad.		0,645
İZOLELİ İĞNE TİP TERMİNAL				
014 100 050015	IIT-1,5 İZOLELİ İĞNE TİP TERM.0,5-1,5MM	200 ad.		0,242
014 100 050025	IIT-2,5 İZOLELİ İĞNE TİP TERM.1,5-2,5MM	200 ad.		0,282
014 100 050040	IIT-4 İZOLELİ İĞNE TİP TERM.4-6MM	100 ad.		0,672
İZOLELİ EK MUF				
014 100 070015	IEM-1,5 İZOLELİ EK MUF 0,5-1,5 MM	200 ad.		0,309
014 100 070025	IEM-2,5 İZOLELİ EK MUF 1,5-2,5 MM	200 ad.		0,336
014 100 070040	IEM-4 İZOLELİ EK MUF 4-6 MM	100 ad.		0,538
İZOLELİ FASTON ERKEK TERMİNAL				
014 100 060015	IFE-1,5 İZO. FASTON ERK. TERM. 1,5 MM	200 ad.		0,336
014 100 060025	IFE-2,5 İZO. FASTON ERK. TERM. 2,5 MM	200 ad.		0,350
014 100 060040	IFE-4 İZO. FASTON ERK. TERM. 4 MM	200 ad.		0,403
İZOLELİ FASTON DIŞI TERMİNAL				
014 100 080510	IDT-0,5-1 İZO. FASTON DIŞI TERM. 0,5-1MM	200 ad.		0,390
014 100 081525	IDT-1,5-2,5 İZO. FASTON DIŞI TERM. 1,5-2,5MM	200 ad.		0,390
014 100 084060	IDT-4-6 İZO. FASTON DIŞI TERM. 4-6 MM	200 ad.		0,471
TAM İZOLELİ DIŞI TERMİNAL				
014 100 090510	TDT-0,5-1 TAM İZO.DIŞI TERM. 0,5-1 MM	100 ad.		0,511
014 100 091525	TDT-1,5-2,5 TAM İZO.DIŞI TERM.1,5-2,5 MM	100 ad.		0,511
014 100 094060	TDT-4-6 TAM İZO.DIŞI TERM. 4-6 MM	100 ad.		0,551
YUVARLAK DIŞI TERMİNAL				
014 100 100510	YDT-0,5-1 YUV. DIŞI TERM. 0,5-1 MM	200 ad.		0,645
014 100 101525	YDT-1,5-2,5 YUV. DIŞI TERM. 1,5-2,5 MM	100 ad.		0,713
014 100 104060	YDT-4-6 YUV. DIŞI TERM. 4-6 MM	100 ad.		0,941
YUVARLAK ERKEK TERMİNAL				
014 100 110510	YET-0,5-1 YUV. ERKEK TERM. 0,5-1 MM	200 ad.		0,538
014 100 111525	YET-1,5-2,5 YUV. ERKEK TERM.1,5-2,5 MM	200 ad.		0,632
014 100 114060	YET-4-6 YUV. ERKEK TERM. 4-6 MM	200 ad.		0,834
FASTON TİP TERMİNALLER İZOLESİZ				
065 100 140003	TSF-1-D 6,3 FASTON TİP TERMİNAL	300 ad.		0,175
065 100 140002	TSF-1-D MİNİ 4,8 FASTON TİP TERMİNAL	500 ad.		0,134
065 100 140001	TSF-1-D GUMUŞ FASTON TİP TERMİNAL	300 ad.		0,672
065 100 140004	TSF-1-E FASTON TİP TERMİNAL	300 ad.		0,161

EKO KABLO PABUÇLARI

KOD	AÇIKLAMA	CİVATA	D3	D2	D1	L	A	ADET	FİYAT
123 037 000016	16-06 EKO TİP KABLO PABUCU	M6	6,5	5,8	7,4	30	12	500	0,854
123 037 000025	25-08 EKO TİP KABLO PABUCU	M8	8,5	7	9,2	40	14	350	1,708
123 037 000035	35-08 EKO TİP KABLO PABUCU	M8	8,5	8,2	10,7	44	15,3	200	2,277
123 037 000050	50-10 EKO TİP KABLO PABUCU	M10	10,5	10,2	12,8	52	20	150	2,846
123 037 000070	70-10 EKO TİP KABLO PABUCU	M10	10,5	11,7	14,7	55	22	100	4,696
123 037 000095	95-12 EKO TİP KABLO PABUCU	M12	13	13,6	16,7	59	26	70	5,408
123 037 000120	120-12 EKO TİP KABLO PABUCU	M12	13	15,5	19	70	29	50	7,685
123 037 000150	150-12 EKO TİP KABLO PABUCU	M12	13	16,7	21	77	32	40	12,239
123 037 000185	185-16 EKO TİP KABLO PABUCU	M16	17	18,8	23	85	35	30	14,658
123 037 000240	240-16 EKO TİP KABLO PABUCU	M16	17	21,2	26	90	38,5	24	21,347

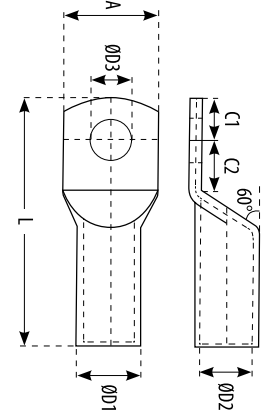

STANDART KABLO PABUÇLARI

KOD	AÇIKLAMA	CİVATA	D3	D2	D1	L	A	ADET	FİYAT
123 037 500010	10-05 STANDART TİP KABLO PABUCU	M5	5,2	4,7	6,5	27,5	10,5	800	0,925
123 037 500011	10-06 STANDART TİP KABLO PABUCU	M6	6,5	4,7	6,5	27,5	10,5	800	0,912
123 037 500012	10-08 STANDART TİP KABLO PABUCU	M8	8,5	4,7	6,5	27,5	10,5	800	1,007
123 037 500016	16-06 STANDART TİP KABLO PABUCU	M6	6,5	5,8	7,4	30	12	500	1,225
123 037 500017	16-08 STANDART TİP KABLO PABUCU	M8	8,5	5,8	7,8	30	12	500	1,361
123 037 500024	25-06 STANDART TİP KABLO PABUCU	M6	6,5	7	9,2	40	14	350	2,314
123 037 500025	25-08 STANDART TİP KABLO PABUCU	M8	8,5	7	9,2	40	14	350	2,178
123 037 500026	25-10 STANDART TİP KABLO PABUCU	M10	10,5	7	9,5	40	14	350	2,314
123 037 500034	35-06 STANDART TİP KABLO PABUCU	M6	6,5	8,2	10,7	44	15,3	200	3,131
123 037 500035	35-08 STANDART TİP KABLO PABUCU	M8	8,5	8,2	10,7	44	15,3	200	2,995
123 037 500036	35-10 STANDART TİP KABLO PABUCU	M10	10,5	8,2	10,7	44	15,3	200	3,063
123 037 500037	35-12 STANDART TİP KABLO PABUCU	M12	13	8,2	10,7	44	15,3	200	3,131
123 037 500049	50-08 STANDART TİP KABLO PABUCU	M8	8,5	10,2	12,8	52	20	150	4,628
123 037 500050	50-10 STANDART TİP KABLO PABUCU	M10	10,5	10,2	12,8	52	20	150	4,492
123 037 500051	50-12 STANDART TİP KABLO PABUCU	M12	13	10,2	12,8	52	20	150	4,628
123 037 500069	70-08 STANDART TİP KABLO PABUCU	M8	8,5	11,7	14,7	55	22	100	6,398
123 037 500070	70-10 STANDART TİP KABLO PABUCU	M10	10,5	11,7	14,7	55	22	100	6,126
123 037 500071	70-12 STANDART TİP KABLO PABUCU	M12	13	11,7	14,7	55	22	100	6,398
123 037 500093	95-08 STANDART TİP KABLO PABUCU	M8	8,5	13,6	16,7	59	26	70	7,759
123 037 500094	95-10 STANDART TİP KABLO PABUCU	M10	10,5	13,6	16,7	59	26	70	7,419
123 037 500095	95-12 STANDART TİP KABLO PABUCU	M12	13	13,6	16,7	59	26	70	7,419
123 037 500119	120-10 STANDART TİP KABLO PABUCU	M10	10,5	15,5	19	70	29	50	10,618
123 037 500120	120-12 STANDART TİP KABLO PABUCU	M12	13	15,5	19	70	29	50	10,618
123 037 500149	150-10 STANDART TİP KABLO PABUCU	M10	10,5	16,7	21	77	32	40	17,288
123 037 500150	150-12 STANDART TİP KABLO PABUCU	M12	13	16,7	21	77	32	40	17,288
123 037 500183	185-10 STANDART TİP KABLO PABUCU	M10	10,5	18,8	23	85	35	30	19,738
123 037 500184	185-12 STANDART TİP KABLO PABUCU	M12	13	18,8	23	85	35	30	19,738
123 037 500185	185-16 STANDART TİP KABLO PABUCU	M16	17	18,8	23	85	35	30	19,738
123 037 500238	240-10 STANDART TİP KABLO PABUCU	M10	10,5	21,2	26	90	38,5	24	27,906
123 037 500239	240-12 STANDART TİP KABLO PABUCU	M12	13	21,2	26	90	38,5	24	27,906
123 037 500240	240-16 STANDART TİP KABLO PABUCU	M16	17	21,2	26	90	38,5	24	27,906
123 037 500299	300-12 STANDART TİP KABLO PABUCU	M12	13	23,5	28,6	100	43	20	34,712
123 037 500300	300-16 STANDART TİP KABLO PABUCU	M16	17	23,5	28,6	100	43	20	34,712
123 037 500400	400-12 STANDART TİP KABLO PABUCU	M12	13	26,8	32,8	108	48	12	57,173
123 037 500401	400-16 STANDART TİP KABLO PABUCU	M16	17	26,8	32,8	108	48	12	57,173
123 037 500402	400-20 STANDART TİP KABLO PABUCU	M20	21	26,8	32,8	108	48	12	57,173



BORU TİP SIKMALI EK MUFLAR

KOD	AÇIKLAMA	D2	D1	L	ADET	FİYAT
123 037 300016	16 MM2 BORU TİP SIKMALI EK MUFU	5,8	7,4	30	350	1,067
123 037 300025	25 MM2 BORU TİP SIKMALI EK MUFU	7,2	9,2	40	350	1,850
123 037 300035	35 MM2 BORU TİP SIKMALI EK MUFU	8,5	11	44	200	2,562
123 037 300050	50 MM2 BORU TİP SIKMALI EK MUFU	10	13	52	150	3,416
123 037 300070	70 MM2 BORU TİP SIKMALI EK MUFU	11,5	14,7	55	100	5,835
123 037 300095	95 MM2 BORU TİP SIKMALI EK MUFU	13,5	16,7	59	70	7,116
123 037 300120	120 MM2 BORU TİP SIKMALI EK MUFU	15,6	19	70	50	8,539
123 037 300150	150 MM2 BORU TİP SIKMALI EK MUFU	17	21	77	40	15,085
123 037 300185	185 MM2 BORU TİP SIKMALI EK MUFU	19	23	85	30	17,931
123 037 300240	240 MM2 BORU TİP SIKMALI EK MUFU	21	26	90	24	26,470



KABLO SOYUCU VE SIYIRICILAR

Kablo Soyucu

No. 4 - 16 / 8 - 28

Çalışma aralığı
4 - 16 mm veya 8 - 28mm Ø



Ürün Kodu	mm	g	Ømm	Fiyat
104 050 050116	140	84	4 - 16	21,01 €
104 050 050227	140	92	8 - 28	21,01 €



4-16mm Ø yuvarlak tüm bilinen kabloların güvenli ve hızlı şekilde soyulması için uygundur.
8-28mm Ø yuvarlak tüm bilinen kabloların güvenli ve hızlı şekilde soyulması için uygundur.

Kablo Soyucu

No. 4 - 28 H

Kancalı bıçak
Çalışma aralığı 4 - 28 mm Ø



Ürün Kodu	mm	g	Ømm	Fiyat
104 050 054328	185	98	4 - 28	21,64 €



4-28mm Ø yuvarlak tüm bilinen kabloların güvenli ve hızlı şekilde soyulması için uygundur.

Coax Sıyırıcı

No. 1 F Plus

F Konnektör için
Çalışma aralığı 6,0 - 8,0 mm Ø



Ürün Kodu	mm	g	Ømm	Fiyat
104 052 000001	125	47	6 - 8	28,07 €



Tek bir işlemle koaksiyel kabloların hızlı bir şekilde soyulması ve sıyırılması işlemine uygundur.
Entegre ek fonksiyonf-tipi vidalı tapaları açma işlemi sağlar. Ayrıca entegre 6 geni kullanarak f konnektörü monte edebilir ve sökebilir.

Combi Coax Sıyırıcı

No. 3

Çalışma aralığı 4,8 - 7,5 mm Ø



Ürün Kodu	mm	g	Ømm	Fiyat
104 052 000003	125	55	4,8 - 7,5	33,45 \$



Tüm yaygın 4,8 - 7,5mm dış çaplı koaksiyel kabloların kademeli olarak sıyırılmasını sağlar.
Aynı zamanda 3x0,75mm², 10mm² ve 16mm² gibi esnek kablolar için uygundur.
Aletin ergonomik şekli hızlı bir sıyırma işlemine imkan verir. Kesim derinliği gerekli değildir.
İyi erişilebilen yan kesimler entegre edilmiştir.

Quadro Sıyırıcı

No. 16

Çalışma aralığı 8 - 13 mm Ø



Ürün Kodu	mm	g	mm ²	Ømm	Fiyat
104 052 000016	125	53	0,5 - 6 (20 - 10 AWG)	8 - 13	40,23 €



Yuvarlak kesim-boyuna kesit- sıyırma- kesme çapları 8 ile 13mm arasındaki tüm yaygın yuvarlak kabloların sıyırılmasını sağlar. Gövdeye entegre optimize edilmiş kablo kanalı sayesinde hızlı ve kolay uzunlamasına kesim imkanı sağlar. 0,5, 0,75, 1, 1,5, 2,5, 4 ve 6mm² arasındaki tüm esnek ve büyük iletkenler için entegre sıyırma aralığı vardır.
Geri çekilebilir kancalı bıçak, her pozisyonda sabitlenir ve kolayca değiştirilir

YENİ
ÜRÜNLERİMİZ

KABLO SOYUCU VE SIYIRICILAR

Kablo Sıyırma Pensesi

No. 5

Pensenin kilitlemesi ile yerden tasarruf sağlanır



0,2- 6mm²'lik yaygın olan masif ve esnek tüm iletkenler için otomatik sıyırma pensesidir. Ayarlanabilir 5-12mm'lik boyuna tesbit parçası, gerektiğinde çıkartılabilir. Max.2mm çapına kadar iyi erişebilen yan kesiciler entegre edilmiştir.

Ürün Kodu	mm	g	mm ²	Fiyat
104 051 000005	170	107	0,2 - 6 (24 - 10 AWG)	42,16 €

Kablo Sıyırma Pensesi

No. 7 Magic

Çok yönlü kablo soyma ve izolasyon çıkarma aleti



Tüm yaygın yuvarlak ve düz kablolar için otomatik sıyırma pensesidir. Çok çeşitli kablo türleri ve çaplarına göre hassas ayar (5 kat) yapılabilmektedir. Optik uzunluk ölçüsü 8-24mm, 5/16 -1". max. 3mmØ'a kadar yan kesiciler entegre edilmiştir.

Ürün Kodu	mm	g	mm ²	Fiyat
104 051 000007	170	217	0,5 - 16 (20 - 6 AWG) 0,5 - 10 (20 - 8 AWG)	102,38 €

Duo-Crimp

No. 300

Sadece bir alet ile sıyırma ve krimpleme



Sadece bir alet ile profesyonel sıyırma ve kıvrma imkanı sağlar. Sıyırma: 0,5-6mm²'lik iletkenin kolay şekilde sıyırılması için uygundur. Kılıfların preslenmesi: 2 pres alanı sunmaktadır: 05-2,5mm² ve 4-6mm².

Ürün Kodu	mm	g	mm ²	Fiyat
104 051 000300	160	116	0,5 - 6 (20 - 10 AWG)	104,03 €

Kablo Sıyırıcı

No. 25

Rahat uzunlamasına ve dairesel kesim için



Kaplama kalınlığı 5mm'ye kadar olan kabloların sıyırılması içindir. Kesme derinliği 0 ile 5mm arasında kademeli olarak ayarlanabilir. Alet kablo dış kılıfının güvenli bir şekilde uzunlamasına ve dairesel kesim yapılmasını sağlar. Dış izolasyonunun kesimi küçük kolun hareketi ile eş zamanlı olarak dişlerin yalıtım üzerine bastırarak gerçekleşir.

Ürün Kodu	mm	g	Fiyat
104 052 000025	210	163	236,76 €

10282 Soyma aparatı

8 - 28mm

Tüm yuvarlak kablo kılıfları soyma

Ürün Kodu	Fiyat
129 087 000355	15,06 €





Kod	Açıklama / Stok Cinsi	Amb. (Kutu)	Amb. Birimi	FİYAT
MEKANİK SKP SIKMA PENSELERİ				
014 101 000650	JY-0650A MEKANİK SKP SIKMA PENSESİ(6-50)	1 ad.		76,63 \$
014 101 000620	JY-06120 MEKANİK SKP SIKMA PENSESİ(6-20)	1 ad.		155,96 \$
014 101 025150	JY-25150 MEKANİK SKP SIKMA PENSESİ(25-150)	1 ad.		161,87 \$
014 101 070240	JY-70240 MEKANİK SKP SIKMA PENSESİ(70-240)	1 ad.		236,70 \$
HİDROLİK SKP SIKMA PENSELERİ				
014 101 004070	YQK-70 HİDROLİK SKP SIKMA PENSESİ (4-70)	1 ad.		161,33 \$
014 101 010120	YYQ-120 HİDROLİK SKP SIKMA PENSESİ (10-120)	1 ad.		174,78 \$
014 101 016240	YQK-240 HİDROLİK SKP SIKMA PENSESİ (16-240)	1 ad.		201,67 \$
014 101 016300	YQK-300 HİDROLİK SKP SIKMA PENSESİ (16-300)	1 ad.		215,11 \$
YÜKSÜK VE İZOLELİ KABLO UCU SIKMA PENSELERİ				
014 101 005056	YAC-5 YÜKSÜK SIKMA PENSESİ(0,5-6)	1 ad.		68,30 \$
014 101 006616	YAC-6 YÜKSÜK SIKMA PENSESİ(6-16)	1 ad.		68,30 \$
014 101 008056	YAC-8 YÜKSÜK SIKMA PENSESİ(0,5-6)(İZOLESİZ KABLO UCU)	1 ad.		84,16 \$
014 101 001056	YYT-1 İZOLELİ KABLO UCU SIKMA PENSESİ(0,5-6)	1 ad.		60,23 \$
014 101 011014	YYT-11 İZOLESİZ KABLO UCU SIKMA PENSESİ(1-4)	1 ad.		68,30 \$
MUTLUSAN KONTROL KALEMLERİ				
104 119 000001	JUMBO DÜZ KONTROL KALEMİ	24 ad.		3,42
104 119 000002	JUMBO YILDIZ KONTROL KALEMİ	12 ad.		3,70
104 119 000003	KOMBO DÜZ KONTROL KALEMİ	12 ad.		3,70
104 119 000004	KOMBO YILDIZ KONTROL KALEMİ	12 ad.		3,99
104 119 500001	LUX DÜZ KONTROL KALEMİ	12 ad.		4,56
104 119 500002	LUX YILDIZ KONTROL KALEMİ	12 ad.		4,84
VIP-TEC KOMBİNE PENSELER				
105 101 210160	VT210160 VIP-TEC KOMBİNE PENSE 160MM	6 ad.		96,80
105 101 210180	VT210180 VIP-TEC KOMBİNE PENSE 180MM	6 ad.		105,34
105 101 215160	VT215160 VIP-TEC YAN KESKİ 160MM	6 ad.		102,49
105 119 210309	VT210309 VIP-TEC MULTIBAG TORN.-PENSE TAKIMI (9 PRÇ)	1 ad.		455,53
VIP-TEC TORNAVİDALAR				
105 101 610031	VT6100/31 VIP-TEC DÜZ UÇLU TORNAVİDA 3.0X75MM	12 ad.		8,07
105 101 610042	VT6100/42 VIP-TEC DÜZ UÇLU TORNAVİDA 4.0X100MM	12 ad.		13,44
105 101 610052	VT6100/52 VIP-TEC DÜZ UÇLU TORNAVİDA 5.5X100MM	12 ad.		15,60
105 101 620031	VT6200/31 VIP-TEC YILDIZ UÇLU TORNAVİDA PH0X75MM	12 ad.		8,07
105 101 620042	VT6200/42 VIP-TEC YILDIZ UÇLU TORNAVİDA PH1X100MM	12 ad.		13,44
105 101 620062	VT6200/62 VIP-TEC YILDIZ UÇLU TORNAVİDA PH2X100MM	12 ad.		17,48
105 101 607000	VT6000/7ST1 VIP-TEC ART TORNAVİDA SETİ (7 PRÇ)	1 ad.		104,87
105 119 006190	VT6190 VIP-TEC DÜZ UÇLU KONTROL KALEMİ 3.5MM	24 ad.		9,95
105 119 006191	VT6191 VIP-TEC YILDIZ UÇLU KONTROL KALEMİ PH0	24 ad.		9,95
105 119 006192	VT6192 VIP-TEC CEP KONTROL KALEMİ 4.0MM	24 ad.		9,95
105 119 006193	VT6193 VIP-TEC DÜZ UÇLU KONTROL KALEMİ 3.5MM	24 ad.		9,95
VIPTEC 1000V İZOLELİ ALETLER				
105 101 201309	VT201309 VIP-TEC 1000V İZOLELİ PENSE-TORN. ÇANTA (9 PRÇ)	1 ad.		591,56
105 101 810032	VT8100/32 VIP-TEC 1000V İZOLELİ DÜZ UÇLU TORN. 3.0X100MM	12 ad.		17,48
105 101 810042	VT8100/42 VIP-TEC 1000V İZOLELİ DÜZ UÇLU TORN. 4.0X100MM	12 ad.		22,86
105 101 810053	VT8100/53 VIP-TEC 1000V İZOLELİ DÜZ UÇLU TORN. 5.5X125MM	12 ad.		26,89
105 101 820030	VT8200/30 VIP-TEC 1000V İZOLELİ YILDIZ UÇLU TORN. PH0X60MM	12 ad.		17,48
105 101 820041	VT8200/41 VIP-TEC 1000V İZOLELİ YILDIZ UÇLU TORN. PH1X80MM	12 ad.		22,86
105 101 820062	VT8200/62 VIP-TEC 1000V İZOLELİ YILDIZ UÇLU TORN. PH2X100MM	12 ad.		26,89
105 101 205180	VT205180 VIP-TEC 1000V İZOLELİ KOMBİNE PENSE 180MM	6 ad.		123,69
105 101 206160	VT206160 VIP-TEC 1000V İZOLELİ YAN KESKİ 160MM	6 ad.		118,31
VIPTEC METAL TAKIM ÇANTASI				
105 101 105051	VT895105D-51 ELEKTRİKÇİ TİP METAL TAKIM ÇANTASI (51 PRÇ)	1 ad.		2.393,11



KOD	AÇIKLAMA	ADET	FİYAT
105 101 896023	VT875102 VIP-TEC PROF. MAKET BİÇAĞI (KÜÇÜK) PLASTİK GÖVDE	36	6,55 TL



KOD	AÇIKLAMA	ADET	FİYAT
105 101 896024	VT875112 VIP-TEC PROF. MAKET BİÇAĞI (KÜÇÜK) METAL GÖVDE	36	9,96 TL



KOD	AÇIKLAMA	ADET	FİYAT
105 101 896028	84 PARÇA MAKET BİÇAĞI SETİ (METAL STAND)	1	885,00 TL



KOD	AÇIKLAMA	ADET	FİYAT
105 101 896025	VT875105 VIP-TEC MAKET BİÇAĞI (BÜYÜK) PLASTİK GÖVDE	36	7,97 TL



KOD	AÇIKLAMA	ADET	FİYAT
105 101 896026	VT875111 VIP-TEC MAKET BİÇAĞI (BÜYÜK) METAL GÖVDE	36	15,66 TL



KOD	AÇIKLAMA	ADET	FİYAT
105 101 896027	VT875000 VIP-TEC (BÜYÜK) MAKET BİÇAĞI YEDEĞİ	100	1,00 TL

YENİ



swiss

OTOMASYONUN YENİ YÜZÜ



SWISS SERİSİ PLASTİK YAYLI BUTONLAR



ÜRÜN KODU
010 104 000003
ÜRÜN ADI
SW-AA42 22MM PLS.
YAYLI BUTON
STOP
AMBALAJ ADET / KOLİ
10
FİYAT
11,68 TL



ÜRÜN KODU
010 104 000004
ÜRÜN ADI
SW-AA31 22MM PLS.
YAYLI BUTON
START
AMBALAJ ADET / KOLİ
10
FİYAT
11,68 TL



ÜRÜN KODU
010 104 000005
ÜRÜN ADI
SW-AA51 22MM PLS.
YAYLI BUTON
START
AMBALAJ ADET / KOLİ
10
FİYAT
11,68 TL



ÜRÜN KODU
010 104 000006
ÜRÜN ADI
SW-AA61 22MM PLS.
YAYLI BUTON
START
AMBALAJ ADET / KOLİ
10
FİYAT
11,68 TL



ÜRÜN KODU
010 104 000007
ÜRÜN ADI
SW-AA21 22MM PLS.
YAYLI BUTON
START
AMBALAJ ADET / KOLİ
10
FİYAT
11,68 TL



ÜRÜN KODU
010 104 000008
ÜRÜN ADI
SW-AA11 22MM PLS.
YAYLI BUTON
START
AMBALAJ ADET / KOLİ
10
FİYAT
11,68 TL

SWISS SERİSİ PLASTİK İŞARETLİ YAYLI BUTONLAR



ÜRÜN KODU
010 104 000009
ÜRÜN ADI
SW-AA4322 22MM
PLASTİK YAYLI BUTON
STOP
AMBALAJ ADET / KOLİ
10
FİYAT
12,87 TL



ÜRÜN KODU
010 104 000010
ÜRÜN ADI
SW-AA3361 22MM
PLASTİK YAYLI BUTON
START
AMBALAJ ADET / KOLİ
10
FİYAT
12,87 TL



ÜRÜN KODU
010 104 000011
ÜRÜN ADI
SW-AA3351 22MM
PLASTİK YAYLI BUTON
START
AMBALAJ ADET / KOLİ
10
FİYAT
12,87 TL



ÜRÜN KODU
010 104 000012
ÜRÜN ADI
SW-AA3341 22MM
PLASTİK YAYLI BUTON
START
AMBALAJ ADET / KOLİ
10
FİYAT
12,87 TL



ÜRÜN KODU
010 104 000013
ÜRÜN ADI
SW-AA3371 22MM
PLASTİK YAYLI BUTON
START
AMBALAJ ADET / KOLİ
10
FİYAT
12,87 TL



ÜRÜN KODU
010 104 000014
ÜRÜN ADI
SW-AA3381 22MM
PLASTİK YAYLI BUTON
START
AMBALAJ ADET / KOLİ
10
FİYAT
12,87 TL

YENİ
ÜRÜNLERİMİZ

SWISS SERİSİ PLASTİK YAYLI İKİZ BUTONLAR



ÜRÜN KODU
010 104 000015
ÜRÜN ADI
SW-AL7325 22 MM
PLASTİK İKİZ BUTON
(1NO/1NC)
AMBALAJ ADET / KOLİ
10
FİYAT
22,47 TL



ÜRÜN KODU
010 104 000016
ÜRÜN ADI
SW-AL7181 22 MM
PLASTİK ALARM-LAM-
BA İKİZ BUTON (1NO/1-
NO)
AMBALAJ ADET / KOLİ
10
FİYAT
24,69 TL



ÜRÜN KODU
010 104 000017
ÜRÜN ADI
SW-AL4252 22 MM
PLASTİK YUKARI AŞAĞI
OKLU TERS YÖNLÜ İKİZ
BUTON (1NO/1NO)
AMBALAJ ADET / KOLİ
10
FİYAT
24,69 TL



ÜRÜN KODU
010 104 000018
ÜRÜN ADI
SW-AL6171 22 MM
PLASTİK ALARM ORTAK
OKLU İKİZ BUTON
(1NO/1NO)
AMBALAJ ADET / KOLİ
10
FİYAT
24,69 TL



ÜRÜN KODU
010 104 000019
ÜRÜN ADI
SW-AL6181 22 MM
PLASTİK LAMBA ORTAK
OKLU İKİZ BUTON
(1NO/1NO)
AMBALAJ ADET / KOLİ
10
FİYAT
24,69 TL



ÜRÜN KODU
010 104 000020
ÜRÜN ADI
SW-AL7425 22 MM
PLASTİK İŞARETLİ
İKİZ BUTON
(1NO/1NC)
AMBALAJ ADET / KOLİ
10
FİYAT
24,69 TL



ÜRÜN KODU
010 104 000021
ÜRÜN ADI
SW-AL7525 22 MM
PLASTİK YAZILI
İKİZ BUTON
(1NO/1NC)
AMBALAJ ADET / KOLİ
10
FİYAT
24,69 TL



ÜRÜN KODU
010 104 000022
ÜRÜN ADI
SW-AL4151 22 MM
PLASTİK YUKARI AŞAĞI
OKLU BUTON
(1NO/1NO)
AMBALAJ ADET / KOLİ
10
FİYAT
24,69 TL



ÜRÜN KODU
010 104 000023
ÜRÜN ADI
SW-AL7465L 22 MM
PLASTİK İKİZ BUTON
(1NO/1NC) LEDLİ
220 VAC/DC
AMBALAJ ADET / KOLİ
10
FİYAT
36,69 TL



ÜRÜN KODU
010 104 000024
ÜRÜN ADI
SW-AL7465-24L 22 MM
PLASTİK İKİZ BUTON
(1NO/1NC) LEDLİ
24 VAC/DC
AMBALAJ ADET / KOLİ
10
FİYAT
36,69 TL

swiss

SWISS SERİSİ PLASTİK KAYICI VE KALICI MANDAL BUTONLAR



ÜRÜN KODU
010 104 000025
ÜRÜN ADI
SW-AD21 PLASTİK
KALICI 0-1 MANDAL
BUTON (1NO)
AMBALAJ ADET / KOLİ
10
FİYAT
14,03 TL



ÜRÜN KODU
010 104 000026
ÜRÜN ADI
SW-AD41 PLASTİK
KAYICI 0-1 MANDAL
BUTON (1NO)
AMBALAJ ADET / KOLİ
10
FİYAT
15,64 TL



ÜRÜN KODU
010 104 000027
ÜRÜN ADI
SW-AD33 PLASTİK
KALICI 2-0-1 MANDAL
BUTON (1NO+1NO)
AMBALAJ ADET / KOLİ
10
FİYAT
20,09 TL



ÜRÜN KODU
010 104 000028
ÜRÜN ADI
SW-AD53 PLASTİK
KAYICI 2-0-1 MANDAL
BUTON (1NO+1NO)
AMBALAJ ADET / KOLİ
10
FİYAT
22,43 TL

SWISS SERİSİ PLASTİK ANAHTARLI KAYICI ve KALICI MANDAL BUTONLAR



ÜRÜN KODU
010 104 000029
ÜRÜN ADI
SW-AG21 PLASTİK
KALICI 0-1 ANAHTARLI
MANDAL BUTON (1NO)
AMBALAJ ADET / KOLİ
10
FİYAT
31,63 TL



ÜRÜN KODU
010 104 000030
ÜRÜN ADI
SW-AG41 PLASTİK
KAYICI 0-1 ANAHTARLI
MANDAL BUTON (1NO)
AMBALAJ ADET / KOLİ
10
FİYAT
35,22 TL



ÜRÜN KODU
010 104 000031
ÜRÜN ADI
SW-AG33 PLS. KALICI
2-0-1 ANH.MANDAL
BUTON (1NO+1NO)
AMBALAJ ADET / KOLİ
10
FİYAT
37,95 TL



ÜRÜN KODU
010 104 000032
ÜRÜN ADI
SW-AG53 PLS. KAYICI
2-0-1 ANH.MANDAL
BUTON (1NO+1NO)
AMBALAJ ADET / KOLİ
10
FİYAT
41,55 TL

SWISS SERİSİ PLASTİK KAYICI MANTAR BUTONLAR



ÜRÜN KODU
010 104 000037
ÜRÜN ADI
SW-AC42 22 MM
PLASTİK KAYICI
MANTAR BUTON(1NC)
AMBALAJ ADET / KOLİ
10
FİYAT
15,27 TL



ÜRÜN KODU
010 104 000038
ÜRÜN ADI
SW-AC31 22 MM
PLASTİK KAYICI
MANTAR BUTON(1NO)
AMBALAJ ADET / KOLİ
10
FİYAT
15,27 TL



ÜRÜN KODU
010 104 000039
ÜRÜN ADI
SW-AC51 22 MM
PLASTİK KAYICI
MANTAR BUTON(1NO)
AMBALAJ ADET / KOLİ
10
FİYAT
15,27 TL

swiss

YENİ
ÜRÜNLERİMİZ

SWISS SERİSİ PLASTİK MANTAR ACİL STOP BUTONLAR



ÜRÜN KODU
010 104 000033
ÜRÜN ADI
SW-AS142 40 MM KAFA
PLASTİK ANAHTARLI
MANTAR BUTON (1NC)
ACİL STOP
AMBALAJ ADET / KOLİ
10
FİYAT
41,40 TL



ÜRÜN KODU
010 104 000034
ÜRÜN ADI
SW-AS542E 40 MM
KAFA PLASTİK MANTAR
BUTON (1NC) ACİL
STOP ETİKETLİ
AMBALAJ ADET / KOLİ
10
FİYAT
19,55 TL



ÜRÜN KODU
010 104 000035
ÜRÜN ADI
SW-AS542 40 MM KAFA
PLASTİK MANTAR
BUTON (1NC) ACİL
STOP
AMBALAJ ADET / KOLİ
10
FİYAT
17,71 TL



ÜRÜN KODU
010 104 000036
ÜRÜN ADI
SW-AS442 30 MM KAFA
PLASTİK MANTAR
BUTON (1NC) ACİL
STOP
AMBALAJ ADET / KOLİ
10
FİYAT
17,88 TL

YAYLI BUTON YEDEK KONTAKLARI VE KILIFI



ÜRÜN KODU
010 104 000060
ÜRÜN ADI
SW-BE101
KONTAK BLOK (NO)
AMBALAJ ADET / KOLİ
50
FİYAT
6,90 TL



ÜRÜN KODU
010 104 000061
ÜRÜN ADI
SW-BE102
KONTAK BLOĞU (NC)
AMBALAJ ADET / KOLİ
50
FİYAT
6,90 TL



ÜRÜN KODU
010 104 000062
ÜRÜN ADI
SW-BE103
IŞIK SOKETİ 10x30
110-240VAC
AMBALAJ ADET / KOLİ
50
FİYAT
17,25 TL

BUTON AKSESUARLARI

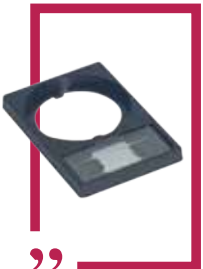

ÜRÜN KODU
010 104 000091
ÜRÜN ADI
SW-BR1
PLASTİK BUTON ROZETİ
(26 x 8 MM CAMLI)
AMBALAJ ADET / KOLİ
100
FİYAT
2,52 TL

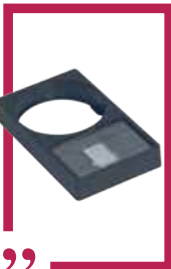

ÜRÜN KODU
010 104 000092
ÜRÜN ADI
SW-BR2
PLASTİK BUTON ROZETİ
(26 x 18 MM CAMLI)
AMBALAJ ADET / KOLİ
100
FİYAT
3,00 TL

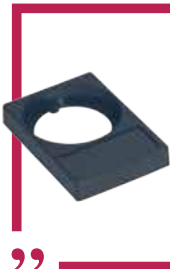

ÜRÜN KODU
010 104 000093
ÜRÜN ADI
SW-SIE-R
PLASTİK BUTON ROZETİ
(27 x 12 MM CAMSIZ)
AMBALAJ ADET / KOLİ
100
FİYAT
2,16 TL



ÜRÜN KODU
010 093 000002
ÜRÜN ADI
SW-BRY
PLASTİK YAZILI BUTON
ROZETİ
AMBALAJ ADET / KOLİ
100
FİYAT
1,40 TL



ÜRÜN KODU
010 093 000001
ÜRÜN ADI
SW-AP2 IP67 BUTON
KORUMA KILIFI (YAYLI
BUTONLAR İÇİN)
AMBALAJ ADET / KOLİ
10
FİYAT
3,80 TL



ÜRÜN KODU
010 104 000099
ÜRÜN ADI
SW-AP4 IP67 İKİZ
BUTON KORUMA KILIFI
(YAYLI BUTONLAR İÇİN)
AMBALAJ ADET / KOLİ
10
FİYAT
3,80 TL

swiss

SWISS SERİSİ PLASTİK LEDLİ, IŞIKLI, YAYLI BUTONLAR



ÜRÜN KODU
010 104 000040
ÜRÜN ADI
SW-AW3475
22 MM LEDLİ IŞIKLI
YAYLI BUTON STOP
(110-240)VAC
AMBALAJ ADET / KOLİ
10
FİYAT
28,23 TL



ÜRÜN KODU
010 104 000041
ÜRÜN ADI
SW-AW3475-24
22 MM LEDLİ IŞIKLI
YAYLI BUTON STOP
(10-30)VAC-DC
AMBALAJ ADET / KOLİ
10
FİYAT
28,23 TL



ÜRÜN KODU
010 104 000042
ÜRÜN ADI
SW-AW3375
22 MM LEDLİ IŞIKLI
YAYLI BUTON START
(110-240)VAC
AMBALAJ ADET / KOLİ
10
FİYAT
28,23 TL



ÜRÜN KODU
010 104 000043
ÜRÜN ADI
SW-AW3375-24
22 MM LEDLİ IŞIKLI
YAYLI BUTON START
(10-30)VAC-DC
AMBALAJ ADET / KOLİ
10
FİYAT
28,23 TL



ÜRÜN KODU
010 104 000044
ÜRÜN ADI
SW-AW3575
22 MM LEDLİ IŞIKLI
YAYLI BUTON START
(110-240)VAC
AMBALAJ ADET / KOLİ
10
FİYAT
28,23 TL



ÜRÜN KODU
010 104 000045
ÜRÜN ADI
SW-AW3575-24
22 MM LEDLİ IŞIKLI
YAYLI BUTON START
(10-30)VAC-DC
AMBALAJ ADET / KOLİ
10
FİYAT
28,23 TL



ÜRÜN KODU
010 104 000046
ÜRÜN ADI
SW-AW3675
22 MM LEDLİ IŞIKLI
YAYLI BUTON START
(110-240)VAC
AMBALAJ ADET / KOLİ
10
FİYAT
28,23 TL



ÜRÜN KODU
010 104 000047
ÜRÜN ADI
SW-AW3675-24
22 MM LEDLİ IŞIKLI
YAYLI BUTON START
(10-30)VAC-DC
AMBALAJ ADET / KOLİ
10
FİYAT
28,23 TL

SWISS SERİSİ 0-1 PLASTİK LEDLİ IŞIKLI KALICI MANDAL BUTONLAR



ÜRÜN KODU
010 104 000048
ÜRÜN ADI
SW-AK123L
0-1 LEDLİ IŞIKLI KALICI
MANDAL BUTON (1NO)
110-240VAC
AMBALAJ ADET / KOLİ
10
FİYAT
31,05 TL



ÜRÜN KODU
010 104 000049
ÜRÜN ADI
SW-AK124L
0-1 LEDLİ IŞIKLI KALICI
MANDAL BUTON (1NC)
110-240VAC
AMBALAJ ADET / KOLİ
10
FİYAT
31,05 TL



ÜRÜN KODU
010 104 000050
ÜRÜN ADI
SW-AK125L
0-1 LEDLİ IŞIKLI KALICI
MANDAL BUTON (1NO)
110-240VAC
AMBALAJ ADET / KOLİ
10
FİYAT
31,05 TL



ÜRÜN KODU
010 104 000051
ÜRÜN ADI
SW-AK123-24L
0-1 LEDLİ IŞIKLI KALICI
MANDAL BUTON(1NO)
10-30VAC-DC
AMBALAJ ADET / KOLİ
10
FİYAT
31,05 TL



ÜRÜN KODU
010 104 000052
ÜRÜN ADI
SW-AK124-24L
0-1 LEDLİ IŞIKLI KALICI
MANDAL BUTON(1NC)
10-30VAC-DC
AMBALAJ ADET / KOLİ
10
FİYAT
31,05 TL



ÜRÜN KODU
010 104 000053
ÜRÜN ADI
SW-AK125-24L
0-1 LEDLİ IŞIKLI KALICI
MANDAL BUTON(1NO)
10-30VAC-DC
AMBALAJ ADET / KOLİ
10
FİYAT
31,05 TL

swiss

YENİ
ÜRÜNLERİMİZ

SWISS SERİSİ 1-0-2 PLASTİK LEDLİ IŞIKLI KALICI MANDAL BUTONLAR



ÜRÜN KODU
010 104 000054
ÜRÜN ADI
SW-AK323L 1-0-2
PLASTİK LEDLİ KALICI
MANDAL BUTON(2NO)
110-240VAC
AMBALAJ ADET / KOLİ
10
FİYAT
37,38 TL



ÜRÜN KODU
010 104 000055
ÜRÜN ADI
SW-AK324L 1-0-2
PLASTİK LEDLİ KALICI
MANDAL BUTON (2NC)
110-240VAC
AMBALAJ ADET / KOLİ
10
FİYAT
37,38 TL



ÜRÜN KODU
010 104 000056
ÜRÜN ADI
SW-AK325L 1-0-2
PLASTİK LEDLİ KALICI
MANDAL BUTON (2NO)
110-240VAC
AMBALAJ ADET / KOLİ
10
FİYAT
37,38 TL



ÜRÜN KODU
010 104 000057
ÜRÜN ADI
SW-AK323-24L 1-0-2
PLASTİK LEDLİ KALICI
MANDAL BUTON(2NO)
10-24VAC-DC
AMBALAJ ADET / KOLİ
10
FİYAT
37,38 TL



ÜRÜN KODU
010 104 000058
ÜRÜN ADI
SW-AK324-24L 1-0-2
PLASTİK LEDLİ KALICI
MANDAL BUTON(2NC)
10-24VAC-DC
AMBALAJ ADET / KOLİ
10
FİYAT
37,38 TL



ÜRÜN KODU
010 104 000059
ÜRÜN ADI
SW-AK325-24L 1-0-2
PLASTİK LEDLİ KALICI
MANDAL BUTON(2NO)
10-24VAC-DC
AMBALAJ ADET / KOLİ
10
FİYAT
37,38 TL

ACIL STOP ETİKETLERİ



ÜRÜN KODU
010 104 000095
ÜRÜN ADI
SW-ER60TE Ø60 MM
PLASTİK ACIL DURDURMA
+ EMERGENCY ROZETİ
(KALIN TİP) LAZER BASKI
AMBALAJ ADET / KOLİ
100
FİYAT
3,28 TL



ÜRÜN KODU
010 104 000096
ÜRÜN ADI
SW-ER60EN-Y Ø60 MM
PLASTİK EMERGENCY
ROZETİ - (İNCE TİP)
LAZER BASKI
AMBALAJ ADET / KOLİ
100
FİYAT
2,30 TL



ÜRÜN KODU
010 093 000003
ÜRÜN ADI
ACIL DURDURMA
ETİKETİ
AMBALAJ ADET / KOLİ
100
FİYAT
4,66 TL



ÜRÜN KODU
010 090 050008
ÜRÜN ADI
SW-AKKM
EMNİYET BASMA
DÜĞMESİ MUHAFAZA
AMBALAJ ADET / KOLİ
10
FİYAT
2,70 TL

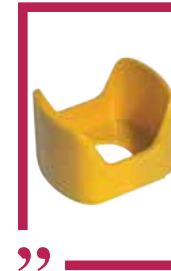

ÜRÜN KODU
010 104 000101
ÜRÜN ADI
SW-AKK
ACIL STOP KORUMA
KAPAĞI
AMBALAJ ADET / KOLİ
10
FİYAT
3,70 TL



ÜRÜN KODU
010 104 000102
ÜRÜN ADI
SW-AKKY
ACIL STOP KORUMA
KAPAĞI - YENİ-
AMBALAJ ADET / KOLİ
10
FİYAT
3,96 TL



ÜRÜN KODU
010 104 000103
ÜRÜN ADI
SW-ASKK ACIL STOP
KORUMA KAPAĞI
(YARIM AY ŞEKLİNDE)
AMBALAJ ADET / KOLİ
10
FİYAT
7,92 TL



ÜRÜN KODU
010 104 000104
ÜRÜN ADI
SW-MKKY MANDAL
BUTON KORUMA
KAPAĞI - YENİ-
AMBALAJ ADET / KOLİ
10
FİYAT
3,17 TL

swiss

SWISS SERİSİ METAL KAPLAMALI YAYLI BUTONLAR



ÜRÜN KODU
010 104 000064
ÜRÜN ADI
SW-BA42
22 MM YAYLI BUTON
STOP (1NC)
AMBALAJ ADET / KOLİ
10
FİYAT
12,87 TL



ÜRÜN KODU
010 104 000065
ÜRÜN ADI
SW-BA31
22 MM YAYLI BUTON
START (1NO)
AMBALAJ ADET / KOLİ
10
FİYAT
12,87 TL



ÜRÜN KODU
010 104 000066
ÜRÜN ADI
SW-BA51
22 MM YAYLI BUTON
START (1NO)
AMBALAJ ADET / KOLİ
10
FİYAT
12,87 TL



ÜRÜN KODU
010 104 000067
ÜRÜN ADI
SW-BA11
22 MM YAYLI BUTON
START (1NO)
AMBALAJ ADET / KOLİ
10
FİYAT
12,87 TL



ÜRÜN KODU
010 104 000068
ÜRÜN ADI
SW-BA61
22 MM YAYLI BUTON
START (1NO)
AMBALAJ ADET / KOLİ
10
FİYAT
12,87 TL



ÜRÜN KODU
010 104 000069
ÜRÜN ADI
SW-BA21
22 MM YAYLI BUTON
START (1NO)
AMBALAJ ADET / KOLİ
10
FİYAT
12,87 TL

SWISS SERİSİ METAL KAPLAMALI İŞARETLİ YAYLI BUTONLAR



ÜRÜN KODU
010 104 000071
ÜRÜN ADI
SW-BA4322
22 MM İŞARETLİ YAYLI
BUTON STOP (1NC)
AMBALAJ ADET / KOLİ
10
FİYAT
14,15 TL



ÜRÜN KODU
010 104 000072
ÜRÜN ADI
SW-BA3351
22 MM İŞARETLİ YAYLI
BUTON START (1NO)
AMBALAJ ADET / KOLİ
10
FİYAT
14,15 TL



ÜRÜN KODU
010 104 000073
ÜRÜN ADI
SW-BA3341
22 MM İŞARETLİ YAYLI
BUTON START (1NO)
AMBALAJ ADET / KOLİ
10
FİYAT
14,15 TL



ÜRÜN KODU
010 104 000074
ÜRÜN ADI
SW-BA3361
22 MM İŞARETLİ YAYLI
BUTON START (1NO)
AMBALAJ ADET / KOLİ
10
FİYAT
14,15 TL



ÜRÜN KODU
010 104 000075
ÜRÜN ADI
SW-BA3371
22 MM İŞARETLİ YAYLI
BUTON START (1NO)
AMBALAJ ADET / KOLİ
10
FİYAT
14,15 TL



ÜRÜN KODU
010 104 000076
ÜRÜN ADI
SW-BA3381
22 MM İŞARETLİ YAYLI
BUTON START (1NO)
AMBALAJ ADET / KOLİ
10
FİYAT
14,15 TL

SWISS SERİSİ METAL KAPLAMALI İKİZ BUTONLARI



ÜRÜN KODU
010 104 000077
ÜRÜN ADI
SW-BL7325
22 MM PLASTİK İKİZ
BUTON (1NO-1NC)
AMBALAJ ADET / KOLİ
10
FİYAT
26,37 TL



ÜRÜN KODU
010 104 000078
ÜRÜN ADI
SW-BL7425 22 MM
PLASTİK İŞARETLİ İKİZ
BUTON (1NO-1NC)
AMBALAJ ADET / KOLİ
10
FİYAT
28,75 TL



ÜRÜN KODU
010 104 000079
ÜRÜN ADI
SW-BL7525 22 MM
PLASTİK YAZILI İKİZ
BUTON (1NO-1NC)
AMBALAJ ADET / KOLİ
10
FİYAT
28,75 TL

swiss

YENİ
ÜRÜNLERİMİZ

SWISS SERİSİ METAL KAPLAMALI İKİZ BUTONLARI



ÜRÜN KODU
010 104 000080
ÜRÜN ADI
SW-BL4151 22 MM
PLASTİK YUKARI-AŞAĞI
OKLU İKİZ BUTON
(1NO-1NO)
AMBALAJ ADET / KOLİ
10
FİYAT
28,75 TL



ÜRÜN KODU
010 104 000081
ÜRÜN ADI
SW-BL4252 22 MM
PLASTİK YUKARI-AŞAĞI
TERS YÖNLÜ İKİZ
BUTON (1NO-1NO)
AMBALAJ ADET / KOLİ
10
FİYAT
28,75 TL



ÜRÜN KODU
010 104 000082
ÜRÜN ADI
SW-BL6171 22 MM
PLASTİK ALARM ORTAK
OKLU İKİZ BUTON
(1NO-1NO)
AMBALAJ ADET / KOLİ
10
FİYAT
28,75 TL



ÜRÜN KODU
010 104 000083
ÜRÜN ADI
SW-BL7181 22 MM
PLASTİK ALARM-LAMBDA
İKİZ BUTON
(1NO-1NO)
AMBALAJ ADET / KOLİ
10
FİYAT
28,75 TL



ÜRÜN KODU
010 104 000084
ÜRÜN ADI
SW-BL6181 22 MM
PLASTİK LAMBA-ORTAK
OKLU İKİZ BUTON
(1NO-1NO)
AMBALAJ ADET / KOLİ
10
FİYAT
28,75 TL



ÜRÜN KODU
010 104 000085
ÜRÜN ADI
SW-BL7465L 22 MM
PLASTİK İKİZ BUTON
LEDLİ 220VAC
AMBALAJ ADET / KOLİ
10
FİYAT
41,33 TL



ÜRÜN KODU
010 104 000086
ÜRÜN ADI
SW-BL7465-24L 22 MM
PLASTİK İKİZ BUTON
LEDLİ 24VAC/DC
AMBALAJ ADET / KOLİ
10
FİYAT
41,33 TL

SWISS SERİSİ METAL KAPLAMALI KAYICI ve KALICI MANDAL BUTONLAR



ÜRÜN KODU
010 104 000087
ÜRÜN ADI
SW-BD21
0-1 KALICI MANDAL
BUTON (1NO)
AMBALAJ ADET / KOLİ
10
FİYAT
15,27 TL



ÜRÜN KODU
010 104 000088
ÜRÜN ADI
SW-BD41
0-1 KAYICI MANDAL
BUTON (1NO)
AMBALAJ ADET / KOLİ
10
FİYAT
17,79 TL



ÜRÜN KODU
010 104 000089
ÜRÜN ADI
SW-BD33
1-0-2 KALICI MANDAL
BUTON (1NO-1NO)
AMBALAJ ADET / KOLİ
10
FİYAT
22,10 TL



ÜRÜN KODU
010 104 000090
ÜRÜN ADI
SW-BD53
1-0-2 KAYICI MANDAL
BUTON (1NO-1NO)
AMBALAJ ADET / KOLİ
10
FİYAT
24,62 TL

swiss

SWISS SERİSİ METAL KAPLAMALI LEDLİ İŞIKLI YAYLI BUTONLAR



ÜRÜN KODU
010 104 000160
ÜRÜN ADI
SW-BW3475
22MM LEDLİ İŞIKLI
YAYLI BUTON STOP
(110-240)VAC
AMBALAJ ADET / KOLİ
10
FİYAT
31,05 TL



ÜRÜN KODU
010 104 000161
ÜRÜN ADI
SW-BW3475-24L
22MM LEDLİ İŞIKLI
YAYLI BUTON STOP
(10-30)VAC-DC
AMBALAJ ADET / KOLİ
10
FİYAT
31,05 TL



ÜRÜN KODU
010 104 000162
ÜRÜN ADI
SW-BW3375
22MM LEDLİ İŞIKLI
YAYLI BUTON START
(110-240)VAC
AMBALAJ ADET / KOLİ
10
FİYAT
31,05 TL



ÜRÜN KODU
010 104 000163
ÜRÜN ADI
SW-BW3375-24L
22MM LEDLİ İŞIKLI
YAYLI BUTON START
(10-30)VAC-DC
AMBALAJ ADET / KOLİ
10
FİYAT
31,05 TL



ÜRÜN KODU
010 104 000164
ÜRÜN ADI
SW-BW3575
22MM LEDLİ İŞIKLI
YAYLI BUTON START
(110-240)VAC
AMBALAJ ADET / KOLİ
10
FİYAT
31,05 TL



ÜRÜN KODU
010 104 000165
ÜRÜN ADI
SW-BW3575-24L
22MM LEDLİ İŞIKLI
YAYLI BUTON START
(10-30)VAC-DC
AMBALAJ ADET / KOLİ
10
FİYAT
31,05 TL



ÜRÜN KODU
010 104 000166
ÜRÜN ADI
SW-BW3675
22MM LEDLİ İŞIKLI
YAYLI BUTON START
(110-240)VAC
AMBALAJ ADET / KOLİ
10
FİYAT
31,05 TL



ÜRÜN KODU
010 104 000167
ÜRÜN ADI
SW-BW3675-24L
22MM LEDLİ İŞIKLI
YAYLI BUTON START
(10-30)VAC-DC
AMBALAJ ADET / KOLİ
10
FİYAT
31,05 TL

SWISS SERİSİ METAL KAPLAMALI 0-1 LEDLİ KALICI MANDAL BUTONLAR



ÜRÜN KODU
010 104 000168
ÜRÜN ADI
SW-BK123L
0-1 LEDLİ İŞIKLI KALICI
MANDAL BUTON (1NO)
110-240VAC
AMBALAJ ADET / KOLİ
10
FİYAT
33,35 TL



ÜRÜN KODU
010 104 000169
ÜRÜN ADI
SW-BK124L
0-1 LEDLİ İŞIKLI KALICI
MANDAL BUTON (1NC)
110-240VAC
AMBALAJ ADET / KOLİ
10
FİYAT
33,35 TL



ÜRÜN KODU
010 104 000170
ÜRÜN ADI
SW-BK125L
0-1 LEDLİ İŞIKLI KALICI
MANDAL BUTON (1NO)
110-240VAC
AMBALAJ ADET / KOLİ
10
FİYAT
33,35 TL



ÜRÜN KODU
010 104 000171
ÜRÜN ADI
SW-BK123-24L 0-1
LEDLİ İŞIKLI KALICI
MANDAL BUTON(1NO)
10-30VAC-DC
AMBALAJ ADET / KOLİ
10
FİYAT
33,35 TL



ÜRÜN KODU
010 104 000172
ÜRÜN ADI
SW-BK124-24L 0-1
LEDLİ İŞIKLI KALICI
MANDAL BUTON(1NC)
10-30VAC-DC
AMBALAJ ADET / KOLİ
10
FİYAT
33,35 TL



ÜRÜN KODU
010 104 000173
ÜRÜN ADI
SW-BK125-24L 0-1
LEDLİ İŞIKLI KALICI
MANDAL BUTON(1NO)
10-30VAC-DC
AMBALAJ ADET / KOLİ
10
FİYAT
33,35 TL

swiss

YENİ
ÜRÜNLERİMİZ

SWISS SERİSİ METAL KAPLAMALI 0-1-2 LEDLİ KALICI MANDAL BUTONLAR



ÜRÜN KODU
010 104 000174
ÜRÜN ADI
SW-BK323L 1-0-2
PLASTİK LEDLİ KALICI
MANDAL BUTON(2NO)
110-240VAC
AMBALAJ ADET / KOLİ
10
FİYAT
39,68 TL



ÜRÜN KODU
010 104 000175
ÜRÜN ADI
SW-BK324L 1-0-2
PLASTİK LEDLİ KALICI
MANDAL BUTON (2NC)
110-240VAC
AMBALAJ ADET / KOLİ
10
FİYAT
39,68 TL



ÜRÜN KODU
010 104 000176
ÜRÜN ADI
SW-BK325L 1-0-2
PLASTİK LEDLİ KALICI
MANDAL BUTON (2NO)
110-240VAC
AMBALAJ ADET / KOLİ
10
FİYAT
39,68 TL



ÜRÜN KODU
010 104 000177
ÜRÜN ADI
SW-BK323-24L 1-0-2
PLASTİK LEDLİ KALICI
MANDAL BUTON(2NO)
10-24VAC-DC
AMBALAJ ADET / KOLİ
10
FİYAT
39,68 TL



ÜRÜN KODU
010 104 000178
ÜRÜN ADI
SW-BK324-24L 1-0-2
PLASTİK LEDLİ KALICI
MANDAL BUTON(2NC)
10-24VAC-DC
AMBALAJ ADET / KOLİ
10
FİYAT
39,68 TL



ÜRÜN KODU
010 104 000179
ÜRÜN ADI
SW-BK325-24L 1-0-2
PLASTİK LEDLİ KALICI
MANDAL BUTON(2NO)
10-24VAC-DC
AMBALAJ ADET / KOLİ
10
FİYAT
39,68 TL

POTANSİYOMETRE



ÜRÜN KODU
010 104 000001
ÜRÜN ADI
MS22-5K
POTANS 5K
AMBALAJ ADET / KOLİ
15
FİYAT
50,00 TL



ÜRÜN KODU
010 104 000002
ÜRÜN ADI
MS22-10K
POTANS 10K
AMBALAJ ADET / KOLİ
15
FİYAT
50,00 TL

VOLTMETRE ve AMPERMETRE



ÜRÜN KODU
999 999 995000
ÜRÜN ADI
22mm Voltmetre Plastik
LED Göstergeli
12-500V AC
AMBALAJ ADET / KOLİ
10
FİYAT
4,84 \$



ÜRÜN KODU
999 999 995001
ÜRÜN ADI
22mm Ampermetre (Akım
Trafolu) Pls. LED Göş.
1A-100A AC 60-380V AC
AMBALAJ ADET / KOLİ
10
FİYAT
9,11 \$



ÜRÜN KODU
999 999 995002
ÜRÜN ADI
22mm Volt+Ampermetre
(Akım Traf.) Pls LED Göş.
12-500V AC 1A-100A AC
AMBALAJ ADET / KOLİ
10
FİYAT
11,68 \$



swiss

MUTLUSAN SİNYAL ve KUMANDA BUTONLARI



ÜRÜN KODU
010 090 010001
ÜRÜN ADI
10MM KABLolu
SİNYAL ARMATÜRÜ
AMBALAJ ADET / KOLİ
100
FİYAT
2,81 TL



ÜRÜN KODU
010 090 010005
ÜRÜN ADI
14MM SİNYAL
ARMATÜRÜ 12V
AMBALAJ ADET / KOLİ
50
FİYAT
3,53 TL



ÜRÜN KODU
010 090 010006
ÜRÜN ADI
14MM SİNYAL
ARMATÜRÜ 24V
AMBALAJ ADET / KOLİ
50
FİYAT
3,53 TL



ÜRÜN KODU
010 090 010007
ÜRÜN ADI
14MM SİNYAL
ARMATÜRÜ 220V
AMBALAJ ADET / KOLİ
50
FİYAT
3,53 TL



ÜRÜN KODU
010 090 010008
ÜRÜN ADI
22MM SİNYAL
ARMATÜRÜ 12V
AMBALAJ ADET / KOLİ
24
FİYAT
3,88 TL



ÜRÜN KODU
010 090 010009
ÜRÜN ADI
22MM SİNYAL
ARMATÜRÜ 24V
AMBALAJ ADET / KOLİ
24
FİYAT
3,88 TL



ÜRÜN KODU
010 090 010010
ÜRÜN ADI
22MM SİNYAL
ARMATÜRÜ 220V
AMBALAJ ADET / KOLİ
24
FİYAT
3,88 TL



ÜRÜN KODU
010 090 010004
ÜRÜN ADI
22MM SİNYAL ARM.
220V LEDLİ
AMBALAJ ADET / KOLİ
24
FİYAT
5,75 TL



ÜRÜN KODU
010 090 070002
ÜRÜN ADI
22MM SİNYAL ARM.
24V LEDLİ
AMBALAJ ADET / KOLİ
24
FİYAT
5,75 TL



ÜRÜN KODU
010 090 010002
ÜRÜN ADI
BA9S DUYLU LEDLİ
22MM SİN. ARM. 220V
AMBALAJ ADET / KOLİ
24
FİYAT
9,36 TL



ÜRÜN KODU
010 111 070001
ÜRÜN ADI
BUZZER 220 VOLT
LEDLİ
AMBALAJ ADET / KOLİ
24
FİYAT
25,00 TL



ÜRÜN KODU
010 111 070002
ÜRÜN ADI
BUZZER 24 VOLT
LEDLİ
AMBALAJ ADET / KOLİ
24
FİYAT
25,00 TL



ÜRÜN KODU
010 111 070003
ÜRÜN ADI
BUZZER
220 VOLT
AMBALAJ ADET / KOLİ
24
FİYAT
21,88 TL



ÜRÜN KODU
010 111 070004
ÜRÜN ADI
BUZZER
24 VOLT
AMBALAJ ADET / KOLİ
24
FİYAT
21,88 TL



ÜRÜN KODU
010 090 050003
ÜRÜN ADI
BA9S LEDLİ YAYLI
İŞIKLI START BUTONU
AMBALAJ ADET / KOLİ
20
FİYAT
26,45 TL



ÜRÜN KODU
010 090 030003
ÜRÜN ADI
BA9S LEDLİ İŞIKLI
SEÇİCİ BUTON 0-1
AMBALAJ ADET / KOLİ
12
FİYAT
29,56 TL



ÜRÜN KODU
010 090 030004
ÜRÜN ADI
BA9S LEDLİ İŞIKLI
SEÇİCİ BUTON 11-0-1
AMBALAJ ADET / KOLİ
12
FİYAT
35,79 TL



ÜRÜN KODU
010 090 050005
ÜRÜN ADI
BA9S LEDLİ YAYLI
İŞIKLI STOP BUTONU
AMBALAJ ADET / KOLİ
20
FİYAT
26,45 TL

YENİ
ÜRÜNLERİMİZ

KUTULU MONTAJLI ÜRÜNLER



ÜRÜN KODU
010 104 000120
ÜRÜN ADI
MS-KK31
1'Lİ KUTULU START
BUTONU (1NO)
AMBALAJ ADET / KOLİ
20
FİYAT
21,10 TL



ÜRÜN KODU
010 104 000121
ÜRÜN ADI
MS-KK42
1'Lİ KUTULU STOP
BUTONU (1NC)
AMBALAJ ADET / KOLİ
20
FİYAT
21,10 TL



ÜRÜN KODU
010 104 000122
ÜRÜN ADI
MS-KK51
1'Lİ KUTULU START
BUTONU (1NO)
AMBALAJ ADET / KOLİ
20
FİYAT
21,10 TL



ÜRÜN KODU
010 104 000123
ÜRÜN ADI
MS-BX71
1'Lİ KUTULU ALARM
BUTONU (1NO)
AMBALAJ ADET / KOLİ
20
FİYAT
22,19 TL



ÜRÜN KODU
010 104 000124
ÜRÜN ADI
MS-BX81 1'Lİ
KUTULU AYDINLATMA
BUTONU (1NO)
AMBALAJ ADET / KOLİ
20
FİYAT
22,19 TL



ÜRÜN KODU
010 104 000125
ÜRÜN ADI
MS-KK7325
1'Lİ KUTULU İKİZ
BUTON (1NO+1NC)
AMBALAJ ADET / KOLİ
20
FİYAT
30,47 TL



ÜRÜN KODU
010 104 000126
ÜRÜN ADI
MS-KK4151 1'Lİ
KUTULU İŞARETLİ İKİZ
BUTON (1NO+1NO)
AMBALAJ ADET / KOLİ
20
FİYAT
32,41 TL



ÜRÜN KODU
010 104 000127
ÜRÜN ADI
MS-KBZ 1'Lİ KUTULU
KABİN ALTI İKAZ
LAMBASI BUZZERLİ
AMBALAJ ADET / KOLİ
20
FİYAT
34,70 TL



ÜRÜN KODU
010 090 050009
ÜRÜN ADI
MS-BX542 1'Lİ
KUTULU ACİL STOP
BUTONU (1NC)
AMBALAJ ADET / KOLİ
18
FİYAT
27,88 TL



ÜRÜN KODU
010 104 000129
ÜRÜN ADI
MS-BX542E 1'Lİ
KUTULU EMERGENCY
STOP BUTONU (1NC)
AMBALAJ ADET / KOLİ
18
FİYAT
29,50 TL



ÜRÜN KODU
010 104 000130
ÜRÜN ADI
MŞ-BX542ASP 1'Lİ KUT.
MÜHÜRLÜ TİP KOR.
ACİL STOP BUT. (1NC)
AMBALAJ ADET / KOLİ
12
FİYAT
46,88 TL



ÜRÜN KODU
010 104 000131
ÜRÜN ADI
MS-BYP3K 1'Lİ
KUTULU 3 KADEME
BY-PASS ANAHTARI
AMBALAJ ADET / KOLİ
12
FİYAT
78,13 TL



ÜRÜN KODU
010 104 000132
ÜRÜN ADI
MS-BY4K 1'Lİ
KUTULU 4 KADEME
BY-PASS ANAHTARLI
AMBALAJ ADET / KOLİ
12
FİYAT
87,50 TL



ÜRÜN KODU
010 104 000133
ÜRÜN ADI
MS-KANT 1'Lİ
KUTULU KAYICI RESET
ANAHTARI
AMBALAJ ADET / KOLİ
18
FİYAT
33,45 TL

swiss

EKO SERİSİ KUMANDA KUTULARI

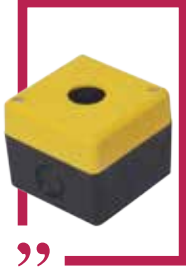

ÜRÜN KODU
010 104 000105
ÜRÜN ADI
EKO101S
EKO 1'li BOŞ
KUMANDA KUTUSU
AMBALAJ ADET / KOLİ
90
FİYAT
5,59 TL



ÜRÜN KODU
010 104 000106
ÜRÜN ADI
EKO201S
EKO 1'li KORUMALI BOŞ
KUMANDA KUTUSU
AMBALAJ ADET / KOLİ
50
FİYAT
6,56 TL



ÜRÜN KODU
010 104 000107
ÜRÜN ADI
EKO301S EKO 1'li ACİL
STOP ETİ.(KOR.) YAZILI
KUMANDA KUTUSU
AMBALAJ ADET / KOLİ
50
FİYAT
25,00 TL



ÜRÜN KODU
010 104 000156
ÜRÜN ADI
EKO401S
EKO 1'li ACİL STOPLU
KUMANDA KUTUSU
AMBALAJ ADET / KOLİ
50
FİYAT
22,88 TL

BOŞ KUMANDA KUTULARI



ÜRÜN KODU
010 091 010001
ÜRÜN ADI
1'Lİ ETANJ
BUTON KUTUSU
EUROBOX
AMBALAJ ADET / KOLİ
24
FİYAT
10,89 TL



ÜRÜN KODU
010 091 010002
ÜRÜN ADI
2'Lİ ETANJ
BUTON KUTUSU
EUROBOX
AMBALAJ ADET / KOLİ
18
FİYAT
14,47 TL



ÜRÜN KODU
010 091 010003
ÜRÜN ADI
3'LÜ ETANJ
BUTON KUTUSU
EUROBOX
AMBALAJ ADET / KOLİ
12
FİYAT
18,36 TL



ÜRÜN KODU
010 091 010004
ÜRÜN ADI
4'LÜ ETANJ
BUTON KUTUSU
EUROBOX
AMBALAJ ADET / KOLİ
10
FİYAT
21,47 TL



ÜRÜN KODU
010 104 000114
ÜRÜN ADI
SW-BX05SB 5'Lİ ETANJ
BUTON KUTUSU
EUROBOX
AMBALAJ ADET / KOLİ
8
FİYAT
26,00 TL



ÜRÜN KODU
010 104 000115
ÜRÜN ADI
SW-BX06SB 6'Lİ ETANJ
BUTON KUTUSU
EUROBOX
AMBALAJ ADET / KOLİ
8
FİYAT
31,00 TL



ÜRÜN KODU
010 104 000116
ÜRÜN ADI
SW-BX07SB 7'Lİ ETANJ
BUTON KUTUSU
EUROBOX
AMBALAJ ADET / KOLİ
6
FİYAT
37,20 TL



ÜRÜN KODU
010 104 000117
ÜRÜN ADI
SW-BX08SB 8'Lİ ETANJ
BUTON KUTUSU
EUROBOX
AMBALAJ ADET / KOLİ
6
FİYAT
43,50 TL



ÜRÜN KODU
010 104 000118
ÜRÜN ADI
SW-BX09SB 9'LU ETANJ
BUTON KUTUSU
EUROBOX
AMBALAJ ADET / KOLİ
1
FİYAT
49,80 TL



ÜRÜN KODU
010 104 000119
ÜRÜN ADI
SW-BX10S 10'LU ETANJ
BUTON KUTUSU
EUROBOX
AMBALAJ ADET / KOLİ
1
FİYAT
55,95 TL

YENİ
ÜRÜNLERİMİZ

KUTULU AÇ-KAPA PANO ŞALTERLERİ



ÜRÜN KODU
010 103 000075
ÜRÜN ADI
0-1 / 10A
AÇ-KAPA KUTULU
PAKO ŞALTER
AMBALAJ ADET / KOLİ
3
FİYAT
43,75 TL



ÜRÜN KODU
010 103 000054
ÜRÜN ADI
0-1 / 16A
AÇ-KAPA KUTULU PAKO
ŞALTER
AMBALAJ ADET / KOLİ
3
FİYAT
51,56 TL



ÜRÜN KODU
010 103 000055
ÜRÜN ADI
0-1 / 25A
AÇ-KAPA KUTULU PAKO
ŞALTER
AMBALAJ ADET / KOLİ
3
FİYAT
65,63 TL



ÜRÜN KODU
010 103 000056
ÜRÜN ADI
0-1 / 3X10A
AÇ-KAPA KUTULU
PAKO ŞALTER
AMBALAJ ADET / KOLİ
3
FİYAT
62,50 TL



ÜRÜN KODU
010 103 000057
ÜRÜN ADI
0-1 / 3X16A
AÇ-KAPA KUTULU PAKO
ŞALTER
AMBALAJ ADET / KOLİ
3
FİYAT
75,00 TL



ÜRÜN KODU
010 103 000058
ÜRÜN ADI
0-1 / 3X25A
AÇ-KAPA KUTULU PAKO
ŞALTER
AMBALAJ ADET / KOLİ
3
FİYAT
93,75 TL

LİFT KUMANDA BUTONU - ÇİFT KONTAKLI



ÜRÜN KODU
010 104 000150
ÜRÜN ADI
MLK-2 TEK HIZLI - 2'Lİ
LİFT KUMANDA - ÇİFT
KONTAKLI - 10A
AMBALAJ ADET / KOLİ
3
FİYAT
65,63 TL



ÜRÜN KODU
010 104 000151
ÜRÜN ADI
MLK-3 TEK HIZLI - 3'LÜ
LİFT KUMANDA - ÇİFT
KONTAKLI - 10A
AMBALAJ ADET / KOLİ
3
FİYAT
87,50 TL



ÜRÜN KODU
010 104 000152
ÜRÜN ADI
MLK-4 TEK HIZLI - 4'LÜ
LİFT KUMANDA - ÇİFT
KONTAKLI - 10A
AMBALAJ ADET / KOLİ
3
FİYAT
109,38 TL



ÜRÜN KODU
010 104 000153
ÜRÜN ADI
MLK-2M TEK HIZLI
2'Lİ LİFT KUMANDA
MIKNATISLI - 10A
AMBALAJ ADET / KOLİ
3
FİYAT
81,25 TL



ÜRÜN KODU
010 104 000154
ÜRÜN ADI
MLK-3M TEK HIZLI
2'Lİ LİFT KUMANDA
MIKNATISLI - 10A
AMBALAJ ADET / KOLİ
3
FİYAT
101,56 TL



ÜRÜN KODU
010 104 000155
ÜRÜN ADI
MLK-4M TEK HIZLI
4'LÜ LİFT KUMANDA
MIKNATISLI - 10A
AMBALAJ ADET / KOLİ
3
FİYAT
125,00 TL

VİNÇ KUTULARI



ÜRÜN KODU
010 092 000001
ÜRÜN ADI
İKİLİ VİNÇ KUTUSU
(TEK HIZLI)
AMBALAJ ADET / KOLİ
1
FİYAT
115,63 TL



ÜRÜN KODU
010 092 000003
ÜRÜN ADI
DÜRTLÜ VİNÇ KUTUSU
(TEK HIZLI)
AMBALAJ ADET / KOLİ
3
FİYAT
156,25 TL

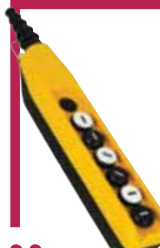

ÜRÜN KODU
010 092 000005
ÜRÜN ADI
ALTILI VİNÇ KUTUSU
(TEK HIZLI)
AMBALAJ ADET / KOLİ
3
FİYAT
203,13 TL



ÜRÜN KODU
010 092 000002
ÜRÜN ADI
ÜÇLÜ VİNÇ KUTUSU
(TEK HIZLI)
AMBALAJ ADET / KOLİ
1
FİYAT
131,25 TL



ÜRÜN KODU
010 092 000004
ÜRÜN ADI
BEŞLİ VİNÇ KUTUSU
(TEK HIZLI)
AMBALAJ ADET / KOLİ
1
FİYAT
171,88 TL



ÜRÜN KODU
010 092 000006
ÜRÜN ADI
YEDİLİ VİNÇ KUTUSU
(TEK HIZLI)
AMBALAJ ADET / KOLİ
F
FİYAT
218,75 TL

ASANSÖR KUYUDİBİ SETLERİ VE KUMANDALARI



ÜRÜN KODU
010 104 000134
ÜRÜN ADI
MS-KYD02
2 Lİ ASANSÖR KUYUDİBİ
BUTON 220 V 16A TOP.
PRİZ+ACİL STOP BUTON
AMBALAJ ADET / KOLİ
9
FİYAT
40,94 TL



ÜRÜN KODU
010 104 000135
ÜRÜN ADI
MS-KYD03
ACİL STOP BUTON + SEÇİCİ
BUT. (2NO) 220V 16A TOP.
PANO PRİZİ
AMBALAJ ADET / KOLİ
6
FİYAT
62,50 TL



ÜRÜN KODU
010 104 000136
ÜRÜN ADI
MS-KYD04
6'LI ACİL STOP BUT. +2 AD.
OKLU BUT. (1NO) 1 İKİZ BUT.
(2NO) 1SEÇ. BUT. (2NO)
AMBALAJ ADET / KOLİ
5
FİYAT
105,00 TL



ÜRÜN KODU
010 104 000137
ÜRÜN ADI
MS-KYD05 ACİL STOP BUTON
+ 2 OKLU BUT. ORTAK OKLU
(1NO) SEÇ. BUTON
(2NO-1NC)
AMBALAJ ADET / KOLİ
4
FİYAT
93,53 TL



ÜRÜN KODU
010 104 000138
ÜRÜN ADI
MS-KYD06 ACİL STOP+ 2
OKLU BUT. (2NO) 1 ORTAK
BUT. (1NO) ALARM BUT. +
SEÇ. BUT. (2NO-1NC)
AMBALAJ ADET / KOLİ
2
FİYAT
105,00 TL



ÜRÜN KODU
010 104 000139
ÜRÜN ADI
KY2-ALR (KORUMALI ACİL
STOP (1NC) NO KONTAKLI
ALARM BUTONU
KOMBİNASYON
AMBALAJ ADET / KOLİ
10
FİYAT
40,94 TL



ÜRÜN KODU
010 104 000140
ÜRÜN ADI
MS-KY5-24 KOR. ACİL STOP
BUT. (1NC)LAMB.VAVİEN
(1NO)24V KATTA LED (1NO)
ALARM BUT. 16A KAP. PRİZ
AMBALAJ ADET / KOLİ
4
FİYAT
106,97 TL



ÜRÜN KODU
010 104 000141
ÜRÜN ADI
MS-KY3 KORUMALI ACİL
STOP+ ALARM BUTONU+
16A KAPAKLI PRİZ KOMBİ-
NASYON
AMBALAJ ADET / KOLİ
5
FİYAT
59,07 TL



ÜRÜN KODU
010 104 000142
ÜRÜN ADI
MS-KY3ES5012
KORUMALI ACİL STOP+
ALARM + 9VOLT PİLLİ 130dB
KOMBİNASYON
AMBALAJ ADET / KOLİ
5
FİYAT
96,81 TL



ÜRÜN KODU
010 104 000143
ÜRÜN ADI
MS-KY4ES5012 KORUMALI
ACİL STOP+ 9VOLT PİLLİ
130dB ALARM VE 16A KAP.
PRİZ KOMBİNASYON
AMBALAJ ADET / KOLİ
4
FİYAT
106,97 TL



ÜRÜN KODU
010 091 020001
ÜRÜN ADI
MS-LV4 YUKARI (1NO)
AŞAĞI(1NO) 0-1 REVİZYON
(1NO) ACİL STOP (1NC) EL
TERMINALİ(EL KUMANDA)
AMBALAJ ADET / KOLİ
6
FİYAT
75,47 TL



ÜRÜN KODU
010 104 000145
ÜRÜN ADI
MS-LV5P YUK. (1NO)ORTAK
(1NO) AŞAĞI(1NO) 0-1 REVİZ.
(1NO) ACİL STOP (1NC) 16A
KAP. PRİZLİ EL TERMINALİ
AMBALAJ ADET / KOLİ
4
FİYAT
106,97 TL



ÜRÜN KODU
010 104 000146
ÜRÜN ADI
MS3BY-BG53P 3KD.BYPASLI
LAMB BUTON (1NO) 24V
KATTA LEDLİ REG.AÇMA(1NO)
16A KAP. PRİZ KOMBİNASYON
AMBALAJ ADET / KOLİ
4
FİYAT
146,00 TL



ÜRÜN KODU
010 104 000147
ÜRÜN ADI
MS9-BX07 YUKARI (1NO)
AŞAĞI(1NO) ORTAK(1NO) 24V
KATTA LEDİ KORU. ACİL STOP
(1NC)ALR. (1NO) LAM. (1NO)
KORU. 0-1 REV. (1NO) 16A
AMBALAJ ADET / KOLİ
1
FİYAT
156,25 TL



ÜRÜN KODU
010 104 000148
ÜRÜN ADI
MS102-ED21 3BY 3KD.BYP
REG.KİL.(1NO) REG.AÇ(1NO)
24V KATTA LED FREN AÇMA
(1NO)KOR.0-1SET RESET (1NO)
AMBALAJ ADET / KOLİ
4
FİYAT
162,44 TL



ÜRÜN KODU
010 104 000149
ÜRÜN ADI
MS201-ED21 REG.AÇ KAPA
(2NO) 24V KATTA LED LAMB
BUTON(1NO) FREN AÇMA1
(1NO) FREN AÇMA2 (1NO)
KORUMALI SET RESET(2NO)
AMBALAJ ADET / KOLİ
4
FİYAT
108,28 TL



ÜRÜN KODU
010 091 020028
ÜRÜN ADI
5 Lİ KORUMALI REVİZYON
KUTUSU
ACİL STOP BUT.+2 ADET
OKLU BUT.+1 ORT. KULL.
BUTON+SEÇİCİ BUTON
AMBALAJ ADET / KOLİ
2
FİYAT
87,52 TL



ÜRÜN KODU
010 091 020029
ÜRÜN ADI
6 Lİ KORUMALI REVİZYON
KUTUSU
ACİL STOP BUT.+2AD. OKLU
BUT.+1OR. KULL. BUT. +
SEÇİCİ BUT.+ALARM BUT.
AMBALAJ ADET / KOLİ
2
FİYAT
97,25 TL

KOMBİNASYON PANOLARI

ÜRÜN KODU
010 104 000180
ÜRÜN ADI
MK-325-2
3/25 A. 1 ADET ÖN+1X16
A 2 ADET YAN
AMBALAJ ADET / KOLİ
9
FİYAT
110,22 TL



ÜRÜN KODU
010 104 000181
ÜRÜN ADI
MK-516-1
5X16 A 1 ADET ÖN
+1X16 A 1 ADET YAN
AMBALAJ ADET / KOLİ
6
FİYAT
77,97 TL



ÜRÜN KODU
010 104 000182
ÜRÜN ADI
MK-516-2
5X16 A 1 ADET ÖN+1X16
A 2 ADET YAN
AMBALAJ ADET / KOLİ
5
FİYAT
127,53 TL



ÜRÜN KODU
010 104 000183
ÜRÜN ADI
MK-532-1
5X32 A 1 ADET ÖN +
1X16 A 1 ADET YAN
AMBALAJ ADET / KOLİ
4
FİYAT
84,94 TL



ÜRÜN KODU
010 104 000184
ÜRÜN ADI
MK-532-2
5X32 A 1 ADET ÖN +
1X16 A 2 ADET YAN
AMBALAJ ADET / KOLİ
2
FİYAT
139,31 TL



ÜRÜN KODU
010 104 000185
ÜRÜN ADI
MK-2325-2
3/25 A. 2 ADET ÖN +
1X16 A 2 ADET YAN
AMBALAJ ADET / KOLİ
10
FİYAT
158,88 TL



ÜRÜN KODU
010 104 000186
ÜRÜN ADI
MK-2516-2
5X16 A. 2 ADET ÖN +
1X16 A 2 ADET YAN
AMBALAJ ADET / KOLİ
4
FİYAT
189,13 TL



ÜRÜN KODU
010 104 000187
ÜRÜN ADI
MK-2516-4
5X16 A. 2 ADET ÖN +
1X16 A 4 ADET YAN
AMBALAJ ADET / KOLİ
5
FİYAT
206,25 TL



ÜRÜN KODU
010 104 000188
ÜRÜN ADI
MK-2532-2
5X32 A. 2 ADET ÖN +
1X16 A 2 ADET YAN
AMBALAJ ADET / KOLİ
5
FİYAT
220,31 TL



ÜRÜN KODU
010 104 000189
ÜRÜN ADI
MK-2532-4
5X32 A. 2 ADET ÖN +
1X16 A 4 ADET YAN
AMBALAJ ADET / KOLİ
4
FİYAT
237,97 TL



ÜRÜN KODU
010 104 000190
ÜRÜN ADI
MK-5164-4
5X16 A. 4 ADET ÖN +
1X16 A 4 ADET YAN
AMBALAJ ADET / KOLİ
6
FİYAT
307,5 TL



ÜRÜN KODU
010 104 000191
ÜRÜN ADI
MK-5324-4
5X32 A. 4 ADET ÖN +
1X16 A 4 ADET YAN
AMBALAJ ADET / KOLİ
4
FİYAT
350,63 TL



ÜRÜN KODU
010 104 000192
ÜRÜN ADI
MK-51632-4 5X16 A.
2 AD. ÖN +5X32 A 2 AD.
ÖN +1X16 4 AD. YAN
AMBALAJ ADET / KOLİ
2
FİYAT
340,00 TL

KOMBİNASYON KUTULARI

ÜRÜN KODU
001 046 075130 00 17
ÜRÜN ADI
1-Lİ KOMBİNASYON KUT.
(BOŞ)(215X130)GRİ
AMBALAJ ADET / KOLİ
1/10
FİYAT
47,79 TL



ÜRÜN KODU
001 046 070220 00 17
ÜRÜN ADI
2-Lİ KOMBİNASYON KUT.
(BOŞ)(290X220)GRİ
AMBALAJ ADET / KOLİ
1/4
FİYAT
59,03 TL

TERMOPLASTİK BUATLAR VE KOMBİNASYON KUTULARI

 <p>ÜRÜN KODU 001 046 000101 00 00 ÜRÜN ADI 85X85 KARE ANTİGRON BUAT AMBALAJ ADET / KOLİ 10/108 FİYAT 3,447 TL</p>	<p>IP65</p>  <p>ÜRÜN KODU 001 046 071827 00 17 ÜRÜN ADI 180X270X100 (14ÇIKIŞ) TERMOPLASTİK BUAT AMBALAJ ADET / KOLİ 2/8 FİYAT 34,392 TL</p>	<p>IP65</p>  <p>ÜRÜN KODU 001 046 076131 00 17 ÜRÜN ADI 138X226X131 TERMOPLASTİK BUAT AMBALAJ ADET / KOLİ 1/8 FİYAT 27,957 TL</p>
<p>IP40</p>  <p>ÜRÜN KODU 001 046 078080 00 17 ÜRÜN ADI 80X80X48 (7ÇIKIŞLI) TERMOPLASTİK BUAT AMBALAJ ADET / KOLİ 18/108 FİYAT 4,037 TL</p>	<p>IP65</p>  <p>ÜRÜN KODU 001 046 078226 00 17 ÜRÜN ADI 138X226X127 KOMBİNASYON KUTUSU AMBALAJ ADET / KOLİ 1/8 FİYAT 32,965 TL</p>	<p>IP65</p>  <p>ÜRÜN KODU 001 046 072698 00 44 ÜRÜN ADI 138X226X98 (ŞEFFAF) TERMOPLASTİK BUAT AMBALAJ ADET / KOLİ 1/8 FİYAT 29,343 TL</p>
<p>IP40</p>  <p>ÜRÜN KODU 001 046 078585 00 17 ÜRÜN ADI 85X85X48 TERMOPLASTİK BUAT AMBALAJ ADET / KOLİ 18/108 FİYAT 4,181 TL</p>	<p>IP65</p>  <p>ÜRÜN KODU 001 046 075311 00 17 ÜRÜN ADI 225X311X132 KOMBİNASYON KUTUSU AMBALAJ ADET / KOLİ 1/4 FİYAT 52,572 TL</p>	<p>IP65</p>  <p>ÜRÜN KODU 001 046 076131 00 44 ÜRÜN ADI 138X226X131 (ŞEFFAF) TERMOPLASTİK BUAT AMBALAJ ADET / KOLİ 1/8 FİYAT 33,123 TL</p>
<p>IP40</p>  <p>ÜRÜN KODU 001 046 070090 00 17 ÜRÜN ADI Ø90 TERMOPLASTİK BUAT AMBALAJ ADET / KOLİ 18/108 FİYAT 6,525 TL</p>	<p>IP65</p>  <p>ÜRÜN KODU 001 046 071199 00 17 ÜRÜN ADI 225X311X99 TERMOPLASTİK BUAT AMBALAJ ADET / KOLİ 1/4 FİYAT 39,730 TL</p>	<p>IP65</p>  <p>ÜRÜN KODU 001 046 071199 00 44 ÜRÜN ADI 225X311X99 (ŞEFFAF) TERMOPLASTİK BUAT AMBALAJ ADET / KOLİ 1/4 FİYAT 48,652 TL</p>
<p>IP65</p>  <p>ÜRÜN KODU 001 046 071010 00 17 ÜRÜN ADI 110X110X74 (8 ÇIKIŞLI) TERMOPLASTİK BUAT AMBALAJ ADET / KOLİ 10/40 FİYAT 9,820 TL</p>	<p>IP65</p>  <p>ÜRÜN KODU 001 046 071130 00 17 ÜRÜN ADI 225X311X130 TERMOPLASTİK BUAT AMBALAJ ADET / KOLİ 1/4 FİYAT 43,457 TL</p>	<p>IP65</p>  <p>ÜRÜN KODU 001 046 071130 00 44 ÜRÜN ADI 225X311X130 (ŞEFFAF) TERMOPLASTİK BUAT AMBALAJ ADET / KOLİ 1/4 FİYAT 50,429 TL</p>
<p>IP65</p>  <p>ÜRÜN KODU 001 046 071118 00 17 ÜRÜN ADI 110X180X77 (10ÇIKIŞ) TERMOPLASTİK BUAT AMBALAJ ADET / KOLİ 5/30 FİYAT 16,614 TL</p>	<p>IP65</p>  <p>ÜRÜN KODU 001 046 072698 00 17 ÜRÜN ADI 138X226X98 TERMOPLASTİK BUAT AMBALAJ ADET / KOLİ 1/8 FİYAT 24,781 TL</p>	

ALEV YAYMAYAN TERMOPLASTİK BUATLAR VE KOMBİNASYON KUTULARI
IP40

ÜRÜN KODU
001 046 098080 00 17
ÜRÜN ADI
80X80X48 (7ÇIKIŞLI)
TERMOPLASTİK BUAT
(GRİ) (A. YAYMAYAN)
AMBALAJ ADET / KOLİ
18/108
FİYAT
6,942 TL

IP65

ÜRÜN KODU
001 046 098226 00 17
ÜRÜN ADI
138X226X127
KOMBİNASYON KUTUSU
(A. YAYMAYAN)
AMBALAJ ADET / KOLİ
1/8
FİYAT
49,030 TL

IP65

ÜRÜN KODU
001 046 092698 00 44
ÜRÜN ADI
138X226X98 (ŞEFFAF)
TERMOPLASTİK BUAT
(A. YAYMAYAN)
AMBALAJ ADET / KOLİ
1/8
FİYAT
43,190 TL

IP40

ÜRÜN KODU
001 046 098585 00 17
ÜRÜN ADI
85X85X48
TERMOPLASTİK BUAT
(GRİ) (A. YAYMAYAN)
AMBALAJ ADET / KOLİ
18/108
FİYAT
6,894 TL

IP65

ÜRÜN KODU
001 046 095311 00 17
ÜRÜN ADI
225X311X132
KOMBİNASYON KUTUSU
(A. YAYMAYAN)
AMBALAJ ADET / KOLİ
1/4
FİYAT
80,008 TL

IP65

ÜRÜN KODU
001 046 096131 00 44
ÜRÜN ADI
138X226X131 (ŞEFFAF)
TERMOPLASTİK BUAT
(A. YAYMAYAN)
AMBALAJ ADET / KOLİ
1/8
FİYAT
45,488 TL

IP40

ÜRÜN KODU
001 046 090090 00 17
ÜRÜN ADI
Ø90
TERMOPLASTİK BUAT
(GRİ) (A. YAYMAYAN)
AMBALAJ ADET / KOLİ
18/108
FİYAT
7,056 TL

IP65

ÜRÜN KODU
001 046 091199 00 17
ÜRÜN ADI
225X311X99
TERMOPLASTİK BUAT
(A. YAYMAYAN)
AMBALAJ ADET / KOLİ
1/4
FİYAT
64,226 TL

IP65

ÜRÜN KODU
001 046 091199 00 44
ÜRÜN ADI
225X311X99 (ŞEFFAF)
TERMOPLASTİK BUAT
(A. YAYMAYAN)
AMBALAJ ADET / KOLİ
1/4
FİYAT
63,270 TL

IP65

ÜRÜN KODU
001 046 091010 00 17
ÜRÜN ADI
110X110X74 (8ÇIKIŞLI)
TERMOPLASTİK BUAT
(A. YAYMAYAN)
AMBALAJ ADET / KOLİ
10/40
FİYAT
18,565 TL

IP65

ÜRÜN KODU
001 046 091130 00 17
ÜRÜN ADI
225X311X130
TERMOPLASTİK BUAT
(A. YAYMAYAN)
AMBALAJ ADET / KOLİ
1/4
FİYAT
71,288 TL

IP65

ÜRÜN KODU
001 046 091130 00 44
ÜRÜN ADI
225X311X130 (ŞEFFAF)
TERMOPLASTİK BUAT
(A. YAYMAYAN)
AMBALAJ ADET / KOLİ
1/4
FİYAT
63,146 TL

IP65

ÜRÜN KODU
001 046 091118 00 17
ÜRÜN ADI
110X180X77 (10 ÇIK.)
TERMOPLASTİK BUAT
(GRİ) (A. YAYMAYAN)
AMBALAJ ADET / KOLİ
5/30
FİYAT
31,964 TL

IP65

ÜRÜN KODU
001 046 092698 00 17
ÜRÜN ADI
138X226X98
TERMOPLASTİK BUAT
(A. YAYMAYAN)
AMBALAJ ADET / KOLİ
1/8
FİYAT
35,798 TL

IP65

ÜRÜN KODU
001 046 091827 00 17
ÜRÜN ADI
180X270X100 (14ÇIK.)
TERMOPLASTİK BUAT
(A. YAYMAYAN)(GRİ)
AMBALAJ ADET / KOLİ
2/8
FİYAT
71,343 TL

IP65

ÜRÜN KODU
001 046 096131 00 17
ÜRÜN ADI
138X226X131
TERMOPLASTİK BUAT
(A. YAYMAYAN)
AMBALAJ ADET / KOLİ
1/8
FİYAT
43,190 TL



**SANAYİ
TİPİ
ÜRÜNLER**



MUTLUSAN SANAYİ FİŞ-PRİZ GRUBU (MONOFAZE 1X16 A.)

 <p>ÜRÜN KODU 010 083 300027 ÜRÜN ADI MUT-27 1X16 A. MONO. TOP. ERKEK FİŞ(EĞİK) AMBALAJ ADET / KOLİ 50/400 FİYAT 7,78 TL</p>	 <p>ÜRÜN KODU 010 083 300028 ÜRÜN ADI MUT-28 1X16 A. MONO. TOP. ERKEK FİŞ(DÜZ) AMBALAJ ADET / KOLİ 50/400 FİYAT 7,78 TL</p>	 <p>ÜRÜN KODU 010 083 300029 ÜRÜN ADI MUT-29 1X16 A. MONO. TOPRAKLI DİŞİ FİŞ AMBALAJ ADET / KOLİ 30/240 FİYAT 13,54 TL</p>
 <p>ÜRÜN KODU 010 083 500296 ÜRÜN ADI MUT-296 1X16 A. MONO. TOP. DUVAR PRİZ AMBALAJ ADET / KOLİ 24/192 FİYAT 21,75 TL</p>	 <p>ÜRÜN KODU 010 083 500293 ÜRÜN ADI MUT-293 1X16 A. MONO. 3'LÜ GRUP PRİZ AMBALAJ ADET / KOLİ 12/96 FİYAT 30,63 TL</p>	 <p>ÜRÜN KODU 010 083 500294 ÜRÜN ADI MUT-294 1X16 A. MONO. 4'LÜ GRUP PRİZ AMBALAJ ADET / KOLİ 10/80 FİYAT 42,20 TL</p>
 <p>ÜRÜN KODU 010 083 501292 ÜRÜN ADI MUT-292A 1X16 A. MONO. 2'Lİ GR. PRİZ ANH. AMBALAJ ADET / KOLİ 12/96 FİYAT 46,68 TL</p>	 <p>ÜRÜN KODU 010 083 501293 ÜRÜN ADI MUT-293A 1X16 A. MONO. 3'LÜ GR. PRİZ ANH. AMBALAJ ADET / KOLİ 10/80 FİYAT 59,38 TL</p>	 <p>ÜRÜN KODU 010 083 500292 ÜRÜN ADI MUT-292 1X16 A. MONO. 2'Lİ GRUP PRİZ AMBALAJ ADET / KOLİ 12/96 FİYAT 27,05 TL</p>

MUTLUSAN SANAYİ FİŞ-PRİZ GRUBU (TRİFAZE 3X25 A.)

 <p>ÜRÜN KODU 010 083 400030 ÜRÜN ADI MUT-30 3X25 TRİFAZE ERKEK FİŞ AMBALAJ ADET / KOLİ 30/240 FİYAT 15,559 TL</p>	 <p>ÜRÜN KODU 010 083 400031 ÜRÜN ADI MUT-31 3X25 TRİFAZE DİŞİ FİŞ (SEYYAR) AMBALAJ ADET / KOLİ 25/200 FİYAT 24,894 TL</p>	 <p>ÜRÜN KODU 010 083 600315 ÜRÜN ADI MUT-315 3X25 TRİFAZE DUVAR PRİZİ AMBALAJ ADET / KOLİ 24/192 FİYAT 31,118 TL</p>
 <p>ÜRÜN KODU 010 083 600311 ÜRÜN ADI MUT-311 1 TRİFAZE 1 MONOFAZE GRUP PRİZ AMBALAJ ADET / KOLİ 10/80 FİYAT 51,344 TL</p>	 <p>ÜRÜN KODU 010 083 600312 ÜRÜN ADI MUT-312 TRİFAZE 2'Lİ GRUP PRİZ AMBALAJ ADET / KOLİ 10/80 FİYAT 56,012 TL</p>	 <p>ÜRÜN KODU 010 083 600313 ÜRÜN ADI MUT-313 TRİFAZE 3'LÜ GRUP PRİZ AMBALAJ ADET / KOLİ 10/80 FİYAT 65,347 TL</p>
 <p>ÜRÜN KODU 010 083 600316 ÜRÜN ADI MUT-316 2 TRİFAZE+1 MONOFAZE GRUP PRİZ AMBALAJ ADET / KOLİ 10/80 FİYAT 65,347 TL</p>	 <p>ÜRÜN KODU 010 083 600317 ÜRÜN ADI MUT-317 1 TRİFAZE+2 MONOFAZE GRUP PRİZ AMBALAJ ADET / KOLİ 10/80 FİYAT 65,347 TL</p>	

MUTLUSAN SANAYİ FİŞ-PRİZ GRUBU (TRİFAZE 3X16 A.)

CE  **ÜRÜN KODU**
010 083 400060
ÜRÜN ADI
MUT-60 3X16 TRİFAZE
ERKEK FİŞ
AMBALAJ ADET / KOLİ
30/240
FİYAT
28,006 TL

CE  **ÜRÜN KODU**
010 083 400061
ÜRÜN ADI
MUT-61 3X16 TRİFAZE
SEYYAR DIŞI FİŞ
AMBALAJ ADET / KOLİ
25/200
FİYAT
34,229 TL

CE  **ÜRÜN KODU**
010 083 400062
ÜRÜN ADI
MUT-62 3X16 TRİFAZE
DUVAR PRİZİ
AMBALAJ ADET / KOLİ
20/160
FİYAT
43,565 TL

MUTLUSAN SANAYİ FİŞ-PRİZ GRUBU (TRİFAZE 3X32 A.)

CE  **ÜRÜN KODU**
010 083 400070
ÜRÜN ADI
MUT-70 3X32 TRİFAZE
ERKEK FİŞ
AMBALAJ ADET / KOLİ
20/160
FİYAT
42,009 TL

CE  **ÜRÜN KODU**
010 083 400071
ÜRÜN ADI
MUT-71 3X32 TRİFAZE
SEYYAR DIŞI FİŞ
AMBALAJ ADET / KOLİ
15/120
FİYAT
46,676 TL

CE  **ÜRÜN KODU**
010 083 400072
ÜRÜN ADI
MUT-72 3X32 TRİFAZE
DUVAR PRİZİ
AMBALAJ ADET / KOLİ
20/160
FİYAT
62,235 TL

MUTLUSAN CEE NORM SANAYİ TİPİ FİŞ ve PRİZLER

CE  **ÜRÜN KODU**
010 083 000516
ÜRÜN ADI
MUT-101 CEE NORM
5X16 A DÜZ FİŞ
AMBALAJ ADET / KOLİ
16/128
FİYAT
34,69 TL

CE  **ÜRÜN KODU**
010 083 000532
ÜRÜN ADI
MUT-201 CEE NORM
5X32 A DÜZ FİŞ
AMBALAJ ADET / KOLİ
15/120
FİYAT
46,19 TL

CE  **ÜRÜN KODU**
010 083 010516
ÜRÜN ADI
MUT-102 CEE NORM
5X16 A UZATMA PRİZİ
AMBALAJ ADET / KOLİ
15/120
FİYAT
45,72 TL

CE  **ÜRÜN KODU**
010 083 010532
ÜRÜN ADI
MUT-202 CEE NORM
5X32 A UZATMA PRİZİ
AMBALAJ ADET / KOLİ
14/112
FİYAT
56,56 TL

CE  **ÜRÜN KODU**
010 083 020516
ÜRÜN ADI
MUT-103 CEE NORM
5X16 A MAKİNE PRİZİ
AMBALAJ ADET / KOLİ
20/160
FİYAT
43,75 TL

CE  **ÜRÜN KODU**
010 083 020532
ÜRÜN ADI
MUT-203 CEE NORM
5X32 A MAKİNE PRİZİ
AMBALAJ ADET / KOLİ
14/112
FİYAT
53,90 TL

CE  **ÜRÜN KODU**
010 083 030516
ÜRÜN ADI
MUT-104 CEE NORM
5X16 A DUVAR PRİZİ
AMBALAJ ADET / KOLİ
8/64
FİYAT
59,38 TL

CE  **ÜRÜN KODU**
010 083 030532
ÜRÜN ADI
MUT-204 CEE NORM
5X32 A DUVAR PRİZİ
AMBALAJ ADET / KOLİ
8/64
FİYAT
66,19 TL

MUTLUSAN SANAYİ FİŞ-PRİZ GRUBU (MONOFAZE 1X16 A.)

CE



ÜRÜN KODU
010 083 500298
ÜRÜN ADI
MUT-298 MONOFAZE
TOPRAKLI PANO PRİZİ
AMBALAJ ADET / KOLİ
40/320
FİYAT
9,335 TL

CE



ÜRÜN KODU
010 083 501297
ÜRÜN ADI
MUT-298-U MONOFAZE
UPS TOP. PANO PRİZİ
AMBALAJ ADET / KOLİ
30/240
FİYAT
15,559 TL

CE



ÜRÜN KODU
010 083 500297
ÜRÜN ADI
MUT-297 MONO.DUVVAR
PRİZİ (PLASTİK)
AMBALAJ ADET / KOLİ
30/240
FİYAT
15,559 TL

CE



ÜRÜN KODU
010 083 500299
ÜRÜN ADI
MUT-299 MONO.
MAKİNA PRİZİ
AMBALAJ ADET / KOLİ
20/160
FİYAT
18,671 TL

CE



ÜRÜN KODU
010 083 502910
ÜRÜN ADI
MUT-2910 MONO.
DUVAR PRİZİ
AMBALAJ ADET / KOLİ
15/120
FİYAT
24,894 TL

MUTLUSAN SANAYİ FİŞ-PRİZ GRUBU (TRİFAZE 3X16 A.)

CE



ÜRÜN KODU
010 083 400064
ÜRÜN ADI
MUT-64 3X16 TRİFAZE
MAKİNA PRİZİ (PLS.)
AMBALAJ ADET / KOLİ
20/160
FİYAT
28,006 TL

CE



ÜRÜN KODU
010 083 400063
ÜRÜN ADI
MUT-63 3X16 TRİFAZE
DUVAR PRİZİ (PLS.)
AMBALAJ ADET / KOLİ
12/96
FİYAT
34,229 TL

MUTLUSAN SANAYİ FİŞ-PRİZ GRUBU (TRİFAZE 3X25 A.)

CE



ÜRÜN KODU
010 083 400318
ÜRÜN ADI
MUT-318 3X25 TRİFAZE
MAKİNA PRİZİ (PLASTİK)
AMBALAJ ADET / KOLİ
20/160
FİYAT
24,894 TL

CE



ÜRÜN KODU
010 083 400319
ÜRÜN ADI
MUT-319 3X25 TRİFAZE
DUVAR PRİZİ (PLASTİK)
AMBALAJ ADET / KOLİ
15/120
FİYAT
31,118 TL

MUTLUSAN SANAYİ FİŞ-PRİZ GRUBU (TRİFAZE 3X32 A.)

CE



ÜRÜN KODU
010 083 400074
ÜRÜN ADI
MUT-74 3X32 TRİFAZE
MAKİNA PRİZİ (PLS.)
AMBALAJ ADET / KOLİ
20/160
FİYAT
34,229 TL

CE



ÜRÜN KODU
010 083 400073
ÜRÜN ADI
MUT-73 3X32 TRİFAZE
DUVAR PRİZİ (PLS.)
AMBALAJ ADET / KOLİ
12/96
FİYAT
40,453 TL



Kod	Açıklama / Stok Cinsi	Amb. (Kutu)	Amb. Birimi	FİYAT
-----	-----------------------	-------------	-------------	-------

SİNTAŞ SANAYİ TİPİ FİŞ PRİZLER

019 107 016250	16X25 A.4 KUTUPLU FİŞ-PRİZ	1 ad.	30	82,97
019 107 016252	16X25 A.4 KUTUPLU PRİZ	1 ad.	45	45,50
019 107 016251	16X25 A.4 KUTUPLU FİŞ	1 ad.	60	37,46
019 107 025400	25x40 A.4 KUTUPLU FİŞ-PRİZ	1 ad.	15	104,69
019 107 025402	25x40 A.4 KUTUPLU PRİZ	1 ad.	25	55,61
019 107 025401	25x40 A.4 KUTUPLU FİŞ	1 ad.	35	49,08
019 107 040630	40X63 A.4 KUTUPLU FİŞ-PRİZ	1 ad.	10	127,33
019 107 040632	40X63 A.4 KUTUPLU PRİZ	1 ad.	15	67,07
019 107 040631	40X63 A.4 KUTUPLU FİŞ	1 ad.	25	60,26
019 107 063100	63X100 A.4 KUTUPLU FİŞ-PRİZ	1 ad.	5	206,27
019 107 063102	63X100 A.4 KUTUPLU PRİZ	1 ad.	10	106,41
019 107 063101	63X100 A.4 KUTUPLU FİŞ	1 ad.	15	99,86

SİNTAŞ SANAYİ TİPİ SEYYAR PRİZLER

019 107 016253	16X25 A.4 KUTUPLU SEYYAR PRİZ	1 ad.	45	41,74
019 107 025403	25x40 A.4 KUTUPLU SEYYAR PRİZ	1 ad.	25	55,61
019 107 040633	40X63 A.4 KUTUPLU SEYYAR PRİZ	1 ad.	15	67,07
019 107 063103	63X100 A.4 KUTUPLU SEYYAR PRİZ	1 ad.	10	106,41

ŞALTERLER

041 118 000201	MONOFAZE ŞALTER	1 ad.	100	22,62
041 118 000200	TRİFAZE ŞALTER	1 ad.	50	41,67

SEYYAR EL LAMBASI

005 084 700016	SEYYAR EL LAMBASI (DUYLU-ANAHTARSIZ)	1 ad.	25	26,89
005 084 700017	SEYYAR EL LAMBASI (DUYLU-ANAHTARLI)	1 ad.	25	32,27

SEYYAR EL LAMBALARI (TEL KAFESLİ)

005 084 700003	BALADOZ PLASTİK SAPLI (DUYSUZ)	1 ad.	25	18,68
005 084 700009	BALADOZ PLASTİK SAPLI (PORS.DUYLU-ANAHTARSIZ)	1 ad.	25	24,66
005 084 700004	BALADOZ PLASTİK SAPLI (PORS.DUYLU-ANHTARLI)	1 ad.	25	29,15
005 084 700006	BALADOZ PLASTİK SAPLI (PORS.DUYLU-ANHTARLI) 5MT 2X0,75 KAB.	1 ad.	15	50,68
005 084 700007	BALADOZ PLASTİK SAPLI (PORS.DUYLU-ANHTARLI) 10MT 2X0,75 KAB.	1 ad.	12	66,62
005 084 700010	BALADOZ PLASTİK SAPLI (PORS.DUYLU-ANHTARLI) 15 MT 2X0,75 KAB.	1 ad.	10	82,56
005 084 700011	BALADOZ PLASTİK SAPLI (PORS.DUYLU-ANHTARLI) 20 MT 2X0,75 KAB.	1 ad.	8	98,51
005 084 700012	BALADOZ PLASTİK SAPLI (PORS.DUYLU-ANHTARLI) 25 MT 2X0,75 KAB.	1 ad.	8	114,45

KABLO MAKARALARI (PLASTİK GÖVDE) (KABLOLU-KABLOSUZ)

005 083 700045	MONOFAZE PLASTİK BOŞ MAKARA (4 MONOFAZE PRİZLİ)	1 ad.		72,60
005 083 700120	MONOFAZE PLASTİK MAKARA 20MT 3X1,5 KAB. (4 MONOFAZE PRİZLİ)	1 ad.		242,00
005 083 700130	MONOFAZE PLASTİK MAKARA 30MT 3X1,5 KAB. (4 MONOFAZE PRİZLİ)	1 ad.		313,18
005 083 700140	MONOFAZE PLASTİK MAKARA 40MT 3X1,5 KAB. (4 MONOFAZE PRİZLİ)	1 ad.		398,59
005 083 700150	MONOFAZE PLASTİK MAKARA 50MT 3X1,5 KAB. (4 MONOFAZE PRİZLİ)	1 ad.		484,00
005 083 700046	TRİFAZE PLASTİK BOŞ MAKARA (1 TRİFAZE + 2 MONOFAZE PRİZLİ)	1 ad.		82,56

BASKILI FİŞLİ UZATMA KABLOLARI

005 083 700005	2 UCU (ERKEK-DİŞİ) BASKILI FİŞLİ UZATMA KABLOSU 5MT 3X1 KAB.	1 ad.		54,52
005 083 700010	2 UCU (ERKEK-DİŞİ) BASKILI FİŞLİ UZATMA KABLOSU 10MT 3X1 KAB.	1 ad.		82,56
005 083 700015	2 UCU (ERKEK-DİŞİ) BASKILI FİŞLİ UZATMA KABLOSU 15MT 3X1 KAB.	1 ad.		114,59
005 083 700020	2 UCU (ERKEK-DİŞİ) BASKILI FİŞLİ UZATMA KABLOSU 20MT 3X1 KAB.	1 ad.		145,20
005 083 700025	2 UCU (ERKEK-DİŞİ) BASKILI FİŞLİ UZATMA KABLOSU 25MT 3X1 KAB.	1 ad.		176,94

BASINÇ ŞALTERLERİ VE SU SEVİYE FLATÖRLERİ

011 095 000500	LM5 (1-6 BAR) MONOFAZE BASINÇ ŞALTERİ 1/4	1 ad.		65,49
011 095 000600	LM6 (2-9 BAR) MONOFAZE BASINÇ ŞALTERİ 1/4	1 ad.		70,85
011 095 000601	LM5 (2-9 BAR) MONOFAZE BSN. ŞALTERİ THL. 1/2	1 ad.		74,08
011 095 000100	LM1 (1-5 BAR) BASINÇ ŞALTERİ TAHLİYESİZ 1/2	1 ad.		65,49
011 095 000101	LM1 (1-5 BAR) BASINÇ ŞALTERİ TAHLİYELİ 1/2	1 ad.		70,85
011 095 000200	LM2 (2-8 BAR) BASINÇ ŞALTERİ TAHLİYESİZ 1/2	1 ad.		81,77
011 095 000201	LM2 (2-8 BAR) BASINÇ ŞALTERİ TAHLİYELİ 1/2	1 ad.		88,39
011 095 000300	LM3 (3-11 BAR) BASINÇ ŞALTERİ TAHLİYESİZ1/2	1 ad.		81,77
011 095 000301	LM3 (3-11 BAR) BASINÇ ŞALTERİ TAHLİYELİ 1/2	1 ad.		88,39
011 095 000400	LM4 (4-16 BAR) BASINÇ ŞALTERİ TAHLİYESİZ 1/2	1 ad.		81,77
011 095 000401	LM4 (4-16 BAR) BASINÇ ŞALTERİ TAHLİYELİ 1/2	1 ad.		88,39
011 096 000591	SU SEVİYE FLATÖRÜ (0,6M TTR KABLOLU)	1 ad.		44,37
011 096 000592	SU SEVİYE FLATÖRÜ (1,6M TTR KABLOLU)	1 ad.		56,18
011 096 000593	SU SEVİYE FLATÖRÜ (3M TTR KABLOLU)	1 ad.		64,41
011 096 000590	SU SEVİYE FLATÖRÜ (5M TTR KABLOLU)	1 ad.		80,52
011 096 000594	SU SEVİYE FLATÖRÜ (10M TTR KABLOLU)	1 ad.		146,72
011 096 000595	ATIK SU SEVİYE FLATÖRÜ (3 MT KAUÇUK KABLOLU)	1 ad.		155,67
011 096 000596	ATIK SU SEVİYE FLATÖRÜ (5 MT KAUÇUK KABLOLU)	1 ad.		171,77
011 096 000597	ATIK SU SEVİYE FLATÖRÜ (10 MT KAUÇUK KABLOLU)	1 ad.		236,18
011 096 000598	ATIK SU SEVİYE FLATÖRÜ (15 MT KAUÇUK KABLOLU)	1 ad.		300,60

Kod	Açıklama / Stok Cinsi	Çalışma Şekli	Besleme Gerilimi	Amb. Birimi	FİYAT
-----	-----------------------	---------------	------------------	-------------	-------

T5 SERİSİ 1 KATLI IŞIKLI KOLONLAR

129 087 000278	S-T5-241	SABİT	24V DC	1 ad.	25\$
129 087 000279	S-T5-221	SABİT	220V AC	1 ad.	30\$
129 087 000281	F-T5-241	FLAŞÖRLÜ	24V DC	1 ad.	39\$
129 087 000282	F-T5-221	FLAŞÖRLÜ	220V AC	1 ad.	42\$
129 087 000284	Ç-T5-241	ÇAKAR	24V DC	1 ad.	39\$
129 087 000285	Ç-T5-221	ÇAKAR	220V AC	1 ad.	42\$
129 087 000287	SB-T5-241	SABİT+BUZZER	24V DC	1 ad.	41\$
129 087 000288	SB-T5-221	SABİT+BUZZER	220V AC	1 ad.	46\$
129 087 000290	FB-T5-241	FLAŞÖRLÜ+BUZZER	24V DC	1 ad.	49\$
129 087 000291	FB-T5-221	FLAŞÖRLÜ+BUZZER	220V AC	1 ad.	54\$
129 087 000293	ÇB-T5-241	ÇAKAR+BUZZER	24V DC	1 ad.	49\$
129 087 000294	ÇB-T5-221	ÇAKAR+BUZZER	220V AC	1 ad.	54\$

T5 SERİSİ 2 KATLI IŞIKLI KOLONLAR

129 087 000296	S-T5-242	SABİT	24V DC	1 ad.	36\$
129 087 000297	S-T5-222	SABİT	220V AC	1 ad.	38\$
129 087 000299	F-T5-242	FLAŞÖRLÜ	24V DC	1 ad.	43\$
129 087 000300	F-T5-222	FLAŞÖRLÜ	220V AC	1 ad.	51\$
129 087 000302	SB-T5-242	SABİT+BUZZER	24V DC	1 ad.	47\$
129 087 000303	SB-T5-222	SABİT+BUZZER	220V AC	1 ad.	52\$
129 087 000305	FB-T5-242	FLAŞÖRLÜ+BUZZER	24V DC	1 ad.	53\$
129 087 000306	FB-T5-222	FLAŞÖRLÜ+BUZZER	220V AC	1 ad.	58\$

T5 SERİSİ 3 KATLI IŞIKLI KOLONLAR

129 087 000308	S-T5-243	SABİT	24V DC	1 ad.	38\$
129 087 000309	S-T5-223	SABİT	220V AC	1 ad.	41\$
129 087 000311	F-T5-243	FLAŞÖRLÜ	24V DC	1 ad.	49\$
129 087 000312	F-T5-223	FLAŞÖRLÜ	220V AC	1 ad.	54\$
129 087 000314	SB-T5-243	SABİT+BUZZER	24V DC	1 ad.	59\$
129 087 000315	SB-T5-223	SABİT+BUZZER	220V AC	1 ad.	64\$
129 087 000317	FB-T5-243	FLAŞÖRLÜ+BUZZER	24V DC	1 ad.	64\$
129 087 000318	FB-T5-223	FLAŞÖRLÜ+BUZZER	220V AC	1 ad.	70\$

T5 SERİSİ 4 KATLI IŞIKLI KOLONLAR

129 087 000254	S-T5-244	SABİT	24V DC	1 ad.	43\$
129 087 000255	S-T5-224	SABİT	220V AC	1 ad.	51\$
129 087 000257	F-T5-244	FLAŞÖRLÜ	24V DC	1 ad.	56\$
129 087 000258	F-T5-224	FLAŞÖRLÜ	220V AC	1 ad.	63\$
129 087 000260	SB-T5-244	SABİT+BUZZER	24V DC	1 ad.	66\$
129 087 000261	SB-T5-224	SABİT+BUZZER	220V AC	1 ad.	74\$
129 087 000263	FB-T5-244	FLAŞÖRLÜ+BUZZER	24V DC	1 ad.	74\$
129 087 000264	FB-T5-224	FLAŞÖRLÜ+BUZZER	220V AC	1 ad.	82\$

T5 SERİSİ 5 KATLI IŞIKLI KOLONLAR

129 087 000266	S-T5-245	SABİT	24V DC	1 ad.	47\$
129 087 000267	S-T5-225	SABİT	220V AC	1 ad.	55\$
129 087 000269	F-T5-245	FLAŞÖRLÜ	24V DC	1 ad.	61\$
129 087 000270	F-T5-225	FLAŞÖRLÜ	220V AC	1 ad.	80\$
129 087 000272	SB-T5-245	SABİT+BUZZER	24V DC	1 ad.	72\$
129 087 000273	SB-T5-225	SABİT+BUZZER	220V AC	1 ad.	80\$
129 087 000275	FB-T5-245	FLAŞÖRLÜ+BUZZER	24V DC	1 ad.	82\$
129 087 000276	FB-T5-225	FLAŞÖRLÜ+BUZZER	220V AC	1 ad.	92\$

T7 SERİSİ 1 KATLI IŞIKLI KOLONLAR

129 087 000651	M-T7-241	MULTİ	24V DC	1 ad.	20\$
129 087 000652	M-T7-221	MULTİ	220V AC	1 ad.	25\$
129 087 000653	MB-T7-241	MULTİ+BUZZER	24V DC	1 ad.	30\$
129 087 000654	MB-T7-221	MULTİ+BUZZER	220V AC	1 ad.	35\$

T7 SERİSİ 2 KATLI IŞIKLI KOLONLAR

129 087 000655	M-T7-242	MULTİ	24V DC	1 ad.	30\$
129 087 000656	M-T7-222	MULTİ	220V AC	1 ad.	35\$
129 087 000657	MB-T7-242	MULTİ+BUZZER	24V DC	1 ad.	40\$
129 087 000658	MB-T7-222	MULTİ+BUZZER	220V AC	1 ad.	45\$

T7 SERİSİ 3 KATLI IŞIKLI KOLONLAR

129 087 000659	M-T7-243	MULTİ	24V DC	1 ad.	35\$
129 087 000660	M-T7-223	MULTİ	220V AC	1 ad.	40\$
129 087 000661	MB-T7-243	MULTİ+BUZZER	24V DC	1 ad.	45\$
129 087 000662	MB-T7-223	MULTİ+BUZZER	220V AC	1 ad.	50\$

T7 SERİSİ 4 KATLI IŞIKLI KOLONLAR

129 087 000663	M-T7-244	MULTİ	24V DC	1 ad.	40\$
129 087 000664	M-T7-224	MULTİ	220V AC	1 ad.	45\$
129 087 000665	MB-T7-244	MULTİ+BUZZER	24V DC	1 ad.	50\$
129 087 000666	MB-T7-224	MULTİ+BUZZER	220V AC	1 ad.	55\$

T7 SERİSİ 5 KATLI IŞIKLI KOLONLAR

129 087 000667	M-T7-245	MULTİ	24V DC	1 ad.	45\$
129 087 000668	M-T7-225	MULTİ	220V AC	1 ad.	50\$
129 087 000669	MB-T7-245	MULTİ+BUZZER	24V DC	1 ad.	55\$
129 087 000670	MB-T7-225	MULTİ+BUZZER	220V AC	1 ad.	60\$

T5

Ø50



T7

Ø70



Işıkli kolonlarda kırmızı sabit renktir. Diğer renkler siparişle yapılabilmektedir.

YENİ

multi



Çap	Kod	Açıklama / Stok Cinsi	Çalışma Şekli	Besleme Gerilimi	Amb. Birimi	FİYAT
PRO SERİSİ 1 KATLI IŞIKLI KOLONLAR						
	129 087 000608	PRO-241	SABİT	24 VDC	1 ad.	80\$
	129 087 000609	PRO-241B	SABİT+BUZZER	24 VDC	1 ad.	90\$
PRO SERİSİ 2 KATLI IŞIKLI KOLONLAR						
	129 087 000610	PRO-242	SABİT	24 VDC	1 ad.	90\$
	129 087 000611	PRO-242B	SABİT+BUZZER	24 VDC	1 ad.	100\$
Ø50	PRO SERİSİ 3 KATLI IŞIKLI KOLONLAR					
	129 087 000612	PRO-243	SABİT	24 VDC	1 ad.	100\$
	129 087 000613	PRO-243B	SABİT+BUZZER	24 VDC	1 ad.	110\$
PRO SERİSİ 4 KATLI IŞIKLI KOLONLAR						
	129 087 000614	PRO-244	SABİT	24 VDC	1 ad.	110\$
	129 087 000615	PRO-244B	SABİT+BUZZER	24 VDC	1 ad.	120\$
PRO SERİSİ 5 KATLI IŞIKLI KOLONLAR						
	129 087 000616	PRO-245	SABİT	24 VDC	1 ad.	120\$
	129 087 000617	PRO-245B	SABİT+BUZZER	24 VDC	1 ad.	130\$



Ø50	PRO SERİSİ 1 KATLI RGB METAL MULTİ RENK İKAZ LAMBALARI					
	129 087 000606	PRO-X324	SABİT	24 VDC	1 ad.	120\$
	129 087 000607	PRO-X324B	SABİT+BUZZER	24 VDC	1 ad.	145\$
Ø60	T6 SERİSİ RGB MULTİ RENK İKAZ LAMBALARI					
	129 087 000671	M-T6-243	MULTİ	24V DC	1 ad.	25\$
	129 087 000672	M-T6-223	MULTİ	220V AC	1 ad.	30\$
	129 087 000673	MB-T6-243	MULTİ+BUZZER	24V DC	1 ad.	30\$
	129 087 000674	MB-T6-223	MULTİ+BUZZER	220V AC	1 ad.	35\$
Ø60	R6 SERİSİ RGB MULTİ RENK İKAZ LAMBALARI					
	129 087 000675	M-R6-243	MULTİ	24V DC	1 ad.	25\$
	129 087 000676	M-R6-223	MULTİ	220V AC	1 ad.	30\$
	129 087 000677	MB-R6-243	MULTİ+BUZZER	24V DC	1 ad.	30\$
	129 087 000678	MB-R6-223	MULTİ+BUZZER	220V AC	1 ad.	35\$
Ø70	T7K SERİSİ RGB MULTİ RENK İKAZ LAMBALARI					
	129 087 000679	M-T7K-243	MULTİ	24V DC	1 ad.	25\$
	129 087 000680	M-T7K-223	MULTİ	220V AC	1 ad.	30\$
	129 087 000681	MB-T7K-243	MULTİ+BUZZER	24V DC	1 ad.	30\$
	129 087 000682	MB-T7K-223	MULTİ+BUZZER	220V AC	1 ad.	35\$
Ø70	R7K SERİSİ RGB MULTİ RENK İKAZ LAMBALARI					
	129 087 000683	M-R7K-243	MULTİ	24V DC	1 ad.	25\$
	129 087 000684	M-R7K-223	MULTİ	220V AC	1 ad.	30\$
	129 087 000685	MB-R7K-243	MULTİ+BUZZER	24V DC	1 ad.	30\$
	129 087 000686	MB-R7K-223	MULTİ+BUZZER	220V AC	1 ad.	35\$
Ø70	V7K SERİSİ RGB MULTİ RENK İKAZ LAMBALARI					
	129 087 000687	M-V7K-243	MULTİ	24V DC	1 ad.	25\$
	129 087 000688	M-V7K-223	MULTİ	220V AC	1 ad.	30\$
	129 087 000689	MB-V7K-243	MULTİ+BUZZER	24V DC	1 ad.	30\$
	129 087 000690	MB-V7K-223	MULTİ+BUZZER	220V AC	1 ad.	35\$
Ø70	QH SERİSİ RGB MULTİ RENK İKAZ LAMBALARI					
	129 087 000691	M-QH-X324	MULTİ	24V DC	1 ad.	40\$
	129 087 000692	M-QH-X322	MULTİ	220V AC	1 ad.	45\$
	129 087 000693	MB-QH-X324	MULTİ+BUZZER	24V DC	1 ad.	45\$
	129 087 000694	MB-QH-X322	MULTİ+BUZZER	220V AC	1 ad.	50\$
Ø70	BH SERİSİ RGB MULTİ RENK İKAZ LAMBALARI					
	129 087 000695	M-BH-X324	MULTİ	24V DC	1 ad.	40\$
	129 087 000696	M-BH-X322	MULTİ	220V AC	1 ad.	45\$
	129 087 000697	MB-BH-X324	MULTİ+BUZZER	24V DC	1 ad.	45\$
	129 087 000698	MB-BH-X322	MULTİ+BUZZER	220V AC	1 ad.	50\$

Çap	Kod	Açıklama / Stok Cinsi	Çalışma Şekli	Besleme Gerilimi	Amb. Birimi	FİYAT
Ø60	T6 SERİSİ MULTİ FONKSİYON İKAZ LAMBALARI					
	129 087 000441	M-T6-24K	MULTİ	24V DC	1 ad.	20\$
	129 087 000442	M-T6-22K	MULTİ	220V AC	1 ad.	25\$
	129 087 000443	MB-T6-24K	MULTİ+BUZZER	24V DC	1 ad.	25\$
	129 087 000444	MB-T6-22K	MULTİ+BUZZER	220V AC	1 ad.	30\$
	R6 SERİSİ MULTİ FONKSİYON İKAZ LAMBALARI					
	129 087 000635	M-R6-24K	MULTİ	24V DC	1 ad.	20\$
	129 087 000636	M-R6-22K	MULTİ	220V AC	1 ad.	25\$
	129 087 000637	MB-R6-24K	MULTİ+BUZZER	24V DC	1 ad.	30\$
	129 087 000638	MB-R6-22K	MULTİ+BUZZER	220V AC	1 ad.	35\$
Ø70	F7 SERİSİ 12... 80 V/DC MOBİL UYGULAMA İÇİN İKAZ LAMBALARI					
	129 087 000622	M-F7-24	MULTİ	24 VDC	1 ad.	40\$
	129 087 000623	M-F7-22	MULTİ	220 VAC	1 ad.	45\$
	129 087 000624	MB-F7-24	MULTİ+BUZZER	24 VDC	1 ad.	45\$
	129 087 000625	MB-F7-22	MULTİ+BUZZER	220 VAC	1 ad.	50\$
	T7K SERİSİ MULTİ FONKSİYON İKAZ LAMBALARI					
	129 087 000639	M-T7K-24	MULTİ	24V DC	1 ad.	20\$
	129 087 000640	M-T7K-22	MULTİ	220V AC	1 ad.	25\$
	129 087 000641	MB-T7K-24	MULTİ+BUZZER	24V DC	1 ad.	30\$
	129 087 000642	MB-T7K-22	MULTİ+BUZZER	220V AC	1 ad.	35\$
Ø80	V8 SERİSİ MULTİ FONKSİYON Q84 İKAZ LAMBALARI					
	129 087 000445	M-V8-24K	MULTİ	24V DC	1 ad.	40\$
	129 087 000446	M-V8-22K	MULTİ	220V AC	1 ad.	45\$
	129 087 000447	MB-V8-24K	MULTİ+BUZZER	24V DC	1 ad.	45\$
	129 087 000448	MB-V8-22K	MULTİ+BUZZER	220V AC	1 ad.	50\$
	T8 SERİSİ MULTİ FONKSİYON İKAZ LAMBALARI					
	129 087 000449	M-T8-24K	MULTİ	24V DC	1 ad.	43\$
	129 087 000450	M-T8-22K	MULTİ	220V AC	1 ad.	48\$
	129 087 000451	MB-T8-24K	MULTİ+BUZZER	24V DC	1 ad.	48\$
	129 087 000452	MB-T8-22K	MULTİ+BUZZER	220V AC	1 ad.	53\$
Ø90	VT8 SERİSİ MULTİ FONKSİYON Q84 İKAZ LAMBALARI					
	129 087 000453	M-VT8-24K	MULTİ	24V DC	1 ad.	43\$
	129 087 000454	M-VT8-22K	MULTİ	220V AC	1 ad.	48\$
	129 087 000455	MB-VT8-24K	MULTİ+BUZZER	24V DC	1 ad.	48\$
	129 087 000456	MB-VT8-22K	MULTİ+BUZZER	220V AC	1 ad.	53\$
	T9 SERİSİ MULTİ FONKSİYON İKAZ LAMBALARI					
	129 087 000457	M-T9-24K	MULTİ	24V DC	1 ad.	40\$
	129 087 000458	M-T9-22K	MULTİ	220V AC	1 ad.	45\$
	129 087 000459	MB-T9-24K	MULTİ+BUZZER	24V DC	1 ad.	45\$
	129 087 000460	MB-T9-22K	MULTİ+BUZZER	220V AC	1 ad.	50\$
Ø90	T9 ÖZEL MULTİ FONKSİYON İKAZ İKAZ LAMBALARI					
	007 087 400105	JM-MM9-12	MULTİ JAKLI	12 V	1 ad.	155\$
	007 087 400109	PM-MM9-12	MULTİ PİLLİ	12 V	1 ad.	150\$
	007 087 400110	FT-MM9-24	MULTİ FOTOSELLİ	12 V	1 ad.	145\$
Ø100	T10 SERİSİ MULTİ FONKSİYON İKAZ LAMBALARI					
	129 087 000643	M-T10-24K	MULTİ	24 VDC	1 ad.	45\$
	129 087 000644	M-T10-22K	MULTİ	220 VAC	1 ad.	50\$
	129 087 000645	MB-T10-24K	MULTİ+BUZZER	24 VDC	1 ad.	50\$
	129 087 000646	MB-T10-22K	MULTİ+BUZZER	220 VAC	1 ad.	55\$
Ø120	T12 SERİSİ MULTİ FONKSİYON İKAZ LAMBALARI					
	129 087 000647	M-T12-24K	MULTİ	24 VDC	1 ad.	50\$
	129 087 000648	M-T12-22K	MULTİ	220 VAC	1 ad.	55\$
	129 087 000649	MB-T12-24K	MULTİ+BUZZER	24 VDC	1 ad.	55\$
	129 087 000650	MB-T12-22K	MULTİ+BUZZER	220 VAC	1 ad.	60\$
HEAVY DUTY SERİSİ İKAZ LAMBALARI						
129 087 000618	HD-22B	7 FARKLI SES	12-24 VDC / 220 VAC	1 ad.	155\$	
129 087 000619	HD-22K	MULTİ	12-24 VDC / 220 VAC	1 ad.	120\$	
129 087 000620	HD-22BK	MULTİ IŞIK+7 FARKLI SES	12-24 VDC / 220 VAC	1 ad.	325\$	



T6



R6



F7



T7K



T8



V8



VT8



T9 ÖZEL



T9



T10



T12



HD-22K



HD-22BK



HD-22B

M70 Modüler

mult

M70
Buzzer

M70
Led Lens

M70
Gövde



MB-BH..1

MB-BH..2

MB-BH..3



MB-QH



B-QH



B-BH

Kod	Açıklama / Stok Cinsi	Çalışma Şekli	Besleme Gerilimi	Amb. Birimi	FİYAT
M70 SERİSİ Q70 MODÜLER SİSTEM İKAZ LAMBA LENSLERİ					
129 087 000626	M67M-24	MULTİ	24 VDC	1 ad.	37\$
129 087 000627	M67M-22	MULTİ	220 VAC	1 ad.	45\$
129 087 000628	M67B-24	SÜREKLİ / KESİK KESİK	24 VDC	1 ad.	29\$
129 087 000629	M67B-22	SÜREKLİ / KESİK KESİK	220 VAC	1 ad.	34\$
129 087 000630	T67-G	GÖVDE		1 ad.	23\$

BH SERİSİ MULTİ 105dB 1 KATLI BORULU KORNALAR					
129 087 000401	MB-BH-241	MULTİ	24V DC	1 ad.	40\$
129 087 000403	MB-BH-221	MULTİ	220V AC	1 ad.	45\$

BH SERİSİ MULTİ 105dB 2 KATLI BORULU KORNALAR					
129 087 000405	MB-BH-242	MULTİ	24V DC	1 ad.	60\$
129 087 000407	MB-BH-222	MULTİ	220V AC	1 ad.	70\$

BH SERİSİ MULTİ 105dB 3 KATLI BORULU KORNALAR					
129 087 000409	MB-BH-243	MULTİ	24V DC	1 ad.	70\$
129 087 000411	MB-BH-223	MULTİ	220V AC	1 ad.	80\$

QH SERİSİ MULTİ 105dB 1 KATLI BORULU KORNALAR					
129 087 000400	MB-QH-241	MULTİ	24V DC	1 ad.	40\$
129 087 000402	MB-QH-221	MULTİ	220V AC	1 ad.	45\$

QH SERİSİ MULTİ 105dB 2 KATLI BORULU KORNALAR					
129 087 000404	MB-QH-242	MULTİ	24V DC	1 ad.	60\$
129 087 000406	MB-QH-222	MULTİ	220V AC	1 ad.	70\$

QH SERİSİ MULTİ 105dB 3 KATLI BORULU KORNALAR					
129 087 000408	MB-QH-243	MULTİ	24V DC	1 ad.	70\$
129 087 000410	MB-QH-223	MULTİ	220V AC	1 ad.	80\$

B-B SERİSİ Q 70 BORULU KORNALAR (SÜREKLİ/KESİK KESİK)					
129 087 000230	B-B-24	95dB/30cm	24V	1 ad.	26\$
129 087 000233	B-B-220	95dB/30cm	220V	1 ad.	26\$
129 087 000631	B-BH-24	115dB/30cm	24V	1 ad.	31\$
129 087 000632	B-BH-220	115dB/30cm	220V	1 ad.	31\$

B-Q SERİSİ Q 70 BORULU KORNALAR (SÜREKLİ/KESİK KESİK)					
129 087 000235	B-Q-24	95dB/30cm	24V	1 ad.	26\$
129 087 000238	B-Q-220	95dB/30cm	220V	1 ad.	26\$
129 087 000633	B-QH-24	115dB/30cm	24V	1 ad.	31\$
129 087 000634	B-QH-220	115dB/30cm	220V	1 ad.	31\$

FM SERİSİ BUZZER (SÜREKLİ/KESİK KESİK)					
129 087 000245	FM-12A-905AL70	90dB/30cm	12V	1 ad.	16\$
129 087 000246	FM-12Q-905L70	95dB/60cm	12V	1 ad.	16\$
129 087 000247	FM-24C-905L70	92dB/100cm	24V	1 ad.	16\$
129 087 000248	FM-220A-905AL70	95dB/30cm	220V	1 ad.	18\$
129 087 000249	FM-24C-900L700	92dB/100cm	24V	1 ad.	14\$
129 087 000250	FM-220A-905A	90dB/300cm	220V	1 ad.	18\$
129 087 000251	FM-12A-905A	90dB/30cm	12V	1 ad.	16\$
129 087 000252	FM-12Q-905	90dB/30cm	12V	1 ad.	14\$



FM-24C



FM-12Q

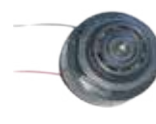

FM-12A

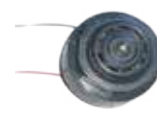

FM-220A



Sürüklenebilir dip sıviç ile 4 farklı modda çalışma

● 8 Farklı Ses Melodisi

● Teknolojisi ile 4 farklı Modda Çalışma

● 0...127 dB Potansiyometre ile Ayarlanabilir Ses Seviyesi

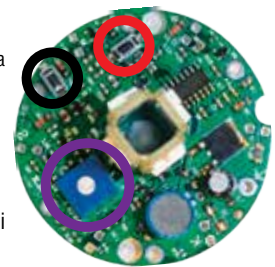

Uçak İkaz Lambaları

Kod	129 087 000600	129 087 000602	129 087 000601	129 087 000603	129 087 000604	129 087 000605
Ürün Adı	ACF-AP	ACF-AD	ACF-BP	ACF-BD	ACF-A2	ACF-B2
Besleme Gerilimi	12, 24 VDC / 110-240 VAC					
Işık Tipi	LEDS					
Sinyal Tipi	Sabit / Flaşör / Çakar					
Renk	Saydam Lens / Işık Kırmızı					
Işık Yoğunluğu	>10 Cd	>10 Cd	>32 Cd	>32 Cd	>10 Cd	>32 Cd
Görüş Açısı	360°					
Lens Materyali	PC					
Gövde Materyali	ABS	Metal	ABS	Metal	Metal	Metal
ICAO Standartı	Annex 14, Volume 1, Chapter 6					
Yedekleme	Opsiyonel					
Kuru Kontak	Opsiyonel					
Gece Gündüz Algılama	✓					
Garanti	2 yıl					
Ağırlık (kg)	0,48	1,1	0,48	1,1	5,3	5,3
Ölçüler (mm)	140x140	140x176	140x140	140x176	140x346x407	140x346x407
Bağlantı Tipi	Kablo					
IP Sınıfı	IP65					
Fiyat	95 \$	115 \$	95 \$	115 \$	260 \$	260 \$



ACF-AP



ACF-AD



ACF-A2

Solar İkaz Lambaları

Kod	007 087 400106	007 087 400107	007 087 400108
Ürün Adı	SLR	SL510	SL512
Güneş Panel Kapasitesi	5W/150 mA	5W	5W
Batarya Kapasitesi	4.8V/200mAh	6V/4.5Ah	6V/4.5Ah
Işık Tipi	LED		
Sinyal Tipi	Flaşör		
Renk	Saydam Lens / Kırmızı Işık		
Işık Yoğunluğu	> 10 Cd	> 10 Cd	> 32 Cd
Görüş Açısı	360°		
Lens Materyali	PC		
Gövde Materyali	ABS		
Şarj Süresi	6 Saat	12 Saat	12 Saat
Çalışma Süresi	12 Saat	48 Saat	36 Saat
Koruma	IP65		
Montaj Tipi	Tabana Montaj		
Ağırlık (kg)	0,41	6,7	6,8
Ölçüler (mm)	98 x 138 x 140	1230 x 255 x 264	1270 x 255 x 264
Fiyat	100 \$	250 \$	350 \$



SLR



SL510

SL512

Uygulama Alanları





Kod	Açıklama / Stok Cinsi	Amb. (Kutu)	Amb. Birimi	FİYAT	
AKILLI KAPI KİLİDİ					
027 112 000010	AKILLI KAPI KİLİDİ	1 ad.		498,24	
027 112 000011	KAPI KONTROL SİSTEMİ 500 HAFIZALI TUŞLU	1 ad.		185,06	
027 112 000012	KAPI KONTROL SİSTEMİ 1000 HAFIZALI KARTLI METAL GÜVDE	1 ad.		270,47	
KAPI VE MERDİVEN OTOMATIĞI					
027 112 000001	GİZLİ KAPI OTOMATIĞI (DOKUNMATİK)	1 ad.	20	86,32	
027 112 000002	GİZLİ KAPI OTOMATIĞI (BASMATIK)	1 ad.	20	86,32	
027 112 000007	ELEK. KİLİTLİ (ANAHTARLI) KAPI OTOMATIĞI	1 ad.	12	166,68	
027 112 000009	ELEKTRİKLI KİLİTLİ KAPI OTOMATIĞI (BİLYELİ)	1 ad.	12	166,68	
027 112 000003	BUTONLU KAPI OTOMATIĞI	1 ad.	30	62,51	
028 112 000004	KAPI OTOMATIĞI (NORMAL)	1 ad.	30	59,53	
027 112 000005	MERDİVEN OTOMATIĞI (RAYLI)	1 ad.	30	50,60	
027 112 000006	MERDİVEN OTOMATIĞI (NORMAL)	1 ad.	30	50,60	
ZİL BUTONU ÇEŞİTLERİ					
037 106 000005	1'Lİ DEKORATİF TİP PLASTİK ZİL BUTONU	1 ad.	40 ad.	4,58	
037 106 020001	1'Lİ ALÜMİNYUM ZİL BUTONU 1.KALİTE	1 ad.		6,85	
037 106 020002	2'Lİ ALÜMİNYUM ZİL BUTONU 1.KALİTE	1 ad.		13,69	
037 106 020003	3'LÜ ALÜMİNYUM ZİL BUTONU 1.KALİTE	1 ad.		20,54	
037 106 020004	4'LÜ ALÜMİNYUM ZİL BUTONU 1.KALİTE	1 ad.		27,38	
037 106 020005	5'Lİ ALÜMİNYUM ZİL BUTONU 1.KALİTE	1 ad.		34,23	
037 106 020006	6'Lİ ALÜMİNYUM ZİL BUTONU 1.KALİTE	1 ad.		41,08	
037 106 020007	7'Lİ ALÜMİNYUM ZİL BUTONU 1.KALİTE	1 ad.		47,92	
037 106 020008	8'Lİ ALÜMİNYUM ZİL BUTONU 1.KALİTE	1 ad.		54,77	
037 106 020009	9'LÜ ALÜMİNYUM ZİL BUTONU 1.KALİTE	1 ad.		61,61	
037 106 020010	10'LÜ ALÜMİNYUM ZİL BUTONU 1.KALİTE	1 ad.		68,46	
ZİLLER VE ZİL TRAFOLARI					
027 105 010012	ZİL TRAFOSU 12 V	€	1 ad.	80	29,76
027 105 010015	ZİL TRAFOSU 15 V	€	1 ad.	40	53,58
028 105 020003	KAMPANA ZİL 220 V	€	1 ad.	24	84,83
028 105 020004	KAMPANA ZİL 12V, 24V, 110V	€	1 ad.	24	101,20
028 105 020000	MUNZAM ZİL ROLÉSİ	€	1 ad.	100	50,60
018 105 000006	KANARYA ZİL (TEK SES)	€	1 ad.	50	16,67
018 105 000007	KANARYA ZİL (ÜÇ SES)	€	1 ad.	50	18,31
018 105 000001	TELEFON ZİLİ (AYARLI)	€	1 ad.	50	20,09
018 105 000002	DİNG DONG ZİL ELEKTRONİK (3 SES)	€	1 ad.	50	22,32
018 105 000003	MEKANİK DİNG DONG ZİL	€	1 ad.	20	80,36
018 105 000004	KONUŞAN ZİL 120 MELODİ	€	1 ad.	30	32,15
DIYAFON MERKEZİ VE ŞUBELERİ					
018 104 000001	DIYAFON MERKEZİ 1'Lİ	€	1 ad.		178,59
018 104 000002	DIYAFON MERKEZİ 2'Lİ	€	1 ad.		187,52
018 104 000003	DIYAFON MERKEZİ 3'LÜ	€	1 ad.		196,45
018 104 000004	DIYAFON MERKEZİ 4'LÜ	€	1 ad.		205,38
018 104 000005	DIYAFON MERKEZİ 5'Lİ	€	1 ad.		214,31
018 104 000099	DIYAFON ŞUBESİ	€	1 ad.		20,84
İTHAL ÜRÜNLERİMİZ					
065 133 001019	10X19 İZOLE BANT - GLOBE	€	10 ad.	500 ad.	0,57 \$
999 999 000081	9V PİLLİ DUMAN DEDEKTÖRÜ	€	1 ad.		16,67 \$
888 038 250027	360 DERECE PİR HAREKET SENSÖRÜ	€	1 ad.		15,45 \$
999 133 011019	ERİYEN BANT	€	1 ad.		2,65 \$
TELEFON DAĞITIM KUTULARI ve AKSESUARLARI					
001 049 001020 00 17	TLF. DĞT. KUTUSU (10 - 20) BOŞ PLS. KLT	€	2 ad.	60	28,29
001 049 201020 00 17	TLF.DĞT.KUTUSU(10-20)BOŞ PLS.(KİLİTLİ) (A. YAYMAYAN)	€	2 ad.	60	34,59
001 049 011020 00 17	TLF. DĞT. KUTUSU (10 - 20) BOŞ KİLİTLİ	€	2 ad.	60	39,52
001 049 211020 00 17	TLF.DĞT.KUTUSU(10-20)BOŞ(KİLİTLİ) (A. YAYMAYAN)	€	2 ad.	60	48,46
001 049 001050 00 17	TLF. DĞT. KUTUSU(10-50) BOŞ PLS.KİLİT	€	1 ad.	28	41,03
001 049 201050 00 17	TLF.DĞT.KUTUSU(10-50)BOŞ PLS.(KİLİTLİ) (A. YAYMAYAN)	€	1 ad.	28	53,79
001 049 011050 00 17	TLF. DĞT. KUTUSU(10-50) KİLİTLİ	€	1 ad.	28	51,72
001 049 211050 00 17	TLF.DĞT.KUTUSU(10-50)(KİLİTLİ) (A. YAYMAYAN)	€	1 ad.	28	56,91
001 024 000001 00 00	ÇATI (1 MODÜL İÇİN)	€	1 ad.	1000	2,62
001 024 000002 00 00	ÇATI (2 MODÜL İÇİN)	€	1 ad.	500	4,96
001 024 000003 00 00	ÇATI (3 MODÜL İÇİN)	€	1 ad.	400	7,55
001 024 000004 00 00	ÇATI (4 MODÜL İÇİN)	€	1 ad.	300	9,91
001 024 000005 00 00	ÇATI (5 MODÜL İÇİN)	€	1 ad.	200	12,23
001 024 000010 00 00	ÇATI (10 MODÜL İÇİN)	€	1 ad.	100	23,42
888 049 050001	KESMESİZ MODÜL	€	10 ad.	250	2,28 \$
888 049 050002	KESMELİ MODÜL	€	10 ad.	250	2,51 \$
888 049 050003	İRTİBATLAMA ALETİ	€	1 ad.	50	13,10 \$
031 049 040001	DAİRE İÇİ TLF.DĞT. KUTUSU (TEK JAKLI)	€	10 ad.	50	0,93 \$
031 049 040002	DAİRE İÇİ TLF.DĞT. KUTUSU (ÇİFT JAKLI)	€	10 ad.	50	1,09 \$
888 049 050005	TELEFON SİRİAL KORDONU	€	1 ad.	100	0,90 \$
888 049 050006	TELEFON KÖKEN KORDON (TEK JAKLI)	€	1 ad.	100	0,74 \$
888 049 050007	TELEFON KÖKEN KORDON (ÇİFT JAKLI)	€	1 ad.	100	0,83 \$
888 101 010012	DATA+TEL. SIKMA PENSESİ 8P6P	€	1 ad.	5	26,19 \$
888 049 050011	VT4001 6P4C PLUG	€	100 ad.	1000	0,04 \$
888 049 050010	VT4003 8P8C PLUG	€	100 ad.	1000	0,09 \$
888 049 050016	VT4006 4P4C SPRAL KORYUCU (FIRDÖNDÜ)	€	1 ad.	100	1,67 \$
FİŞ ÇEŞİTLERİ					
999 999 000186	2 MT. KABLOLU BASKILI TEYP FİŞİ	€	1 ad.		6,32
031 114 020005	TV ERKEK FİŞ	€	100 ad.		1,61
031 114 020006	TV DIŞI FİŞ	€	100 ad.		1,61
031 114 000050	OK-050 F KONNEKTÖR RG-6	€	100 ad.		0,67
031 114 000051	OK-051 F KONNEKTÖR RG-59	€	100 ad.		0,67
031 114 000057	OK-057 F ARA KONNEKTÖR	€	100 ad.		1,08
031 114 000088	OK-88İ JAKLI TELEFON FİŞİ	€	50 ad.		0,81



ÜRÜN KODU
888 038 218000
ÜRÜN ADI
Q218 KABLOSUZ KAPI ZİLİ
LEDLİ 100 MT. 32MELODİ
AMBALAJ ADET / KOLİ
1 ad. / 10
FİYAT
15,158 \$



ÜRÜN KODU
888 038 007000
ÜRÜN ADI
007-D KAPI/PENCERE
ALARMI 2 SESLİ
AMBALAJ ADET / KOLİ
1 ad. / 10
FİYAT
4,894 \$



ÜRÜN KODU
888 038 008000
ÜRÜN ADI
008-C LEDLİ INFAR. PIR. SEN.
ALARM/KAPI ZİL 32M.8MT
AMBALAJ ADET / KOLİ
1 ad. / 10
FİYAT
15,799 \$



ÜRÜN KODU
018 105 114800
ÜRÜN ADI
A-148 KAPI ZİLİ
(32 MELODİLİ)
AMBALAJ ADET / KOLİ
1 ad. / 10
FİYAT
19,448 \$



ÜRÜN KODU
018 105 158100
ÜRÜN ADI
X-581 KAPI ZİLİ
(32 MELODİLİ)
AMBALAJ ADET / KOLİ
1 ad. / 10
FİYAT
19,448 \$



ÜRÜN KODU
018 105 162800
ÜRÜN ADI
WA-628 KAPI ZİLİ
(32 MELODİLİ) BEYAZ
AMBALAJ ADET / KOLİ
1 ad. / 10
FİYAT
21,538 \$



ÜRÜN KODU
018 105 162811
ÜRÜN ADI
WA-628 KAPI ZİLİ
(32 MELODİLİ) SİYAH
AMBALAJ ADET / KOLİ
1 ad. / 10
FİYAT
21,538 \$



ÜRÜN KODU
018 105 163800
ÜRÜN ADI
WA-638 KAPI ZİLİ
(32 MELODİLİ) BEYAZ
AMBALAJ ADET / KOLİ
1 ad. / 10
FİYAT
21,538 \$



ÜRÜN KODU
018 105 163811
ÜRÜN ADI
WA-638 KAPI ZİLİ
(32 MELODİLİ) SİYAH
AMBALAJ ADET / KOLİ
1 ad. / 10
FİYAT
21,538 \$

YANGIN ALGILAMA ve İKAZ SİSTEMLERİ



LEDLİ
FLAŞÖR + DÖNER

2
FONKSİYONLU



YENİ

İKAZ KORNASI

026 112 010001	İKAZ KORNASI 220 V	CE	1 ad.	45 ad.	42,71
028 120 000001	İKAZ BUTONU (KARE)		2 ad.	90 ad.	18,51

ALARM KORNA VE YANGIN İHBAR BUTONU

010 090 050050	RESETLENEBİLİR BUTON	CE	2 ad.		59,53
010 090 050051	RESETLENEBİLİR BUTON (KAPAKLI)		1 ad.		65,48
028 120 010006	ALARM KORNA PLAŞTİK		1 ad.		65,48
028 120 010005	ALARM KORNA DÖKÜM		1 ad.		71,44

DÖNER LAMBA FLAŞÖR SİREN REFKONTAK

001 111 020006 00 00	LEDLİ 2 FONKSİYONLU (FLAŞÖR-DÖNER) İKAZ LAMBASI 220 V		1 ad.		15,63 \$
001 111 020004 00 00	DÖNER LAMBA 220 V AC		1 ad.		157,75
001 111 020001 00 00	DÖNER LAMBA 12 V AC		1 ad.		157,75
001 111 020002 00 00	DÖNER LAMBA 24 V AC		1 ad.		157,75
001 111 030003 00 00	FLAŞÖRLÜ İKAZ LAMBASI 220 V		1 ad.		104,18
026 111 020005	12 V.DC.MIKNATISLI DÖNER LAMBA(OTO TİPİ)		1 ad.		267,88
102 111 000012	LEDLİ FLAŞÖRLÜ ELEKTRONİK SİREN 12V		1 ad.		68,46
102 111 000024	LEDLİ FLAŞÖRLÜ ELEKTRONİK SİREN 24V		1 ad.		68,46
102 111 000220	LEDLİ FLAŞÖRLÜ ELEKTRONİK SİREN 220V		1 ad.		80,36
102 111 000221	LEDLİ FLAŞÖRLÜ ELEKTRONİK SİREN 220V. (YENİ MODEL)		1 ad.		99,00
026 111 000001	UÇAK İKAZ LAMBASI (AMPULLÜ)		1 ad.		223,24
026 111 000002	UÇAK İKAZ LAMBA SEHPASI		1 ad.		163,71
888 111 050004	MS190 MİNİ SİREN (105 db)		1 ad.		17,26 \$
026 111 010001	AS. 1 MOTORLU SİREN (PLS. GÖV.)220V,100W (110 db.)		1 ad.		119,06
026 111 010002	AS. 2 MOTORLU SİREN (PLS. GÖV.)220V,100W (117 db.)		1 ad.		178,59
026 111 010003	AS. 1 MOTORLU SİREN (METAL. GÖV.)220V,100W (115 db.)	CE	1 ad.		193,47
026 111 010004	AS. 2 MOTORLU SİREN (METAL. GÖV.)220V,100W (120 db.)	CE	1 ad.		238,12
026 111 010005	AS.3 MOTORLU SİREN 220V-280W (150 db.)	CE	1 ad.		1.488,24



028 120 000001



888 111 050004



026 112 010001



010 090 010005



010 090 010006



026 111 010003



010 090 050051



026 111 000001



102 111 000220



026 111 000001



102 111 000221



001 111 020006 00 00



Kod	Açıklama / Stok Cinsi	Amb. (Kutu)	Amb. Birimi	FİYAT
-----	-----------------------	-------------	-------------	-------

YANGIN İHBAR KONTROL PANELLERİ STANDART

006 086 601004	EFİRE ECP-1004 4 ZONLU KONTROL PANELİ	1 ad.		220 \$
006 086 601008	EFİRE ECP-1008 8 ZONLU KONTROL PANELİ	1 ad.		240 \$
006 086 601012	EFİRE ECP-1012 12 ZONLU KONTROL PANELİ	1 ad.		270 \$
006 086 601016	EFİRE ECP-1016 16 ZONLU KONTROL PANELİ	1 ad.		320 \$
006 086 601036	EFİRE-EEXP-1 4 ALGILAMA + 1 SONDURME BÖLGEİ PANEL	1 ad.		475 \$
006 086 601040	EFİRE-EEXP-2 4 ALGILAMA + 2 SONDURME BÖLGEİ PANEL	1 ad.		600 \$

YANGIN İHBAR KONTROL TEKRARLAMA PANELLERİ

006 086 001005	EFİRE ECP-RP 4 ZONLU TEKRARLAMA PANELİ	1 ad.		180 \$
006 086 001007	EFİRE ECP-RP 8 ZONLU TEKRARLAMA PANELİ	1 ad.		195 \$
006 086 001012	EFİRE ECP-RP 12 ZONLU TEKRARLAMA PANELİ	1 ad.		210 \$
006 086 001017	EFİRE ECP-RP 16 ZONLU TEKRARLAMA PANELİ	1 ad.		300 \$
006 086 200015	E-NW-485 TEKRARLAMA PANEL NETWORK KARTI	1 ad.		75 \$

KURU VE SIZDIRMAZ TİP BAKIM GEREKTİRMEYEN AKÜLER

006 086 101220	BAT-1220 12V / 2AH. KURU TİP AKÜ	1 ad.		29 \$
006 086 101270	BAT-1270 12V / 7AH. KURU TİP AKÜ	1 ad.		35 \$

YANGIN İHBAR DEDEKTÖRLERİ

006 086 200001	EFİRE EOD OPTİK DUMAN DEDEKTÖRÜ	1 ad.		19 \$
006 086 200005	EFİRE EHD-58 SABİT SICAKLIK DEDEKTÖRÜ-58 C	1 ad.		14 \$
006 086 200006	EFİRE EHD-82 SABİT SICAKLIK DEDEKTÖRÜ-82 C	1 ad.		14 \$
006 086 200002	EFİRE ERD SICAKLIK ARTIŞ HIZI DEDEKTÖRÜ	1 ad.		14 \$
006 086 326225	EFİRE ECD KOMBİNE (DUMAN+İSİ) DEDEKTÖRÜ	1 ad.		26 \$
006 086 200003	EFİRE EDB STANDART DEDEKTÖR SOKETİ	1 ad.		3 \$

YANGIN İHBAR BUTON, SİRENLERİ VE AKSESUARLARI

006 086 300001	EFİRE EYİB YNG.İHB.BUT. VE KASASI 12-24V	1 ad.		12 \$
006 086 401224	AS-1224 ELEKTRONİK SİREN	1 ad.		13 \$
006 086 500009	AS-1224-LED FLAŞORLU ELEKTRONİK SİREN	1 ad.		25 \$
006 086 700009	E-PİL-PARALEL İHBAR LAMBASI	1 ad.		12 \$
999 999 777149	EGD 200-220-LPG GAZ DEDEKTÖRÜ 220V	1 ad.		30 \$
999 999 777164	EGD 200-24-LPG GAZ DEDEKTÖRÜ 12-24V	1 ad.		30 \$
006 086 400220	AS220-ELEKTRONİK SİREN 220V	1 ad.		15 \$
006 086 500010	AS220-LED ELEKTRONİK SİREN 220V	1 ad.		27 \$
006 125 100110	EFİRE EYİB NO/NC-YANGIN İHBAR BUTONU NO/NC ÇIKIŞLI 220V	1 ad.		14 \$
006 125 100120	EFİRE-EFB-6" YANGIN ÇANI	1 ad.		26 \$

ÖZEL AMAÇLI ÜRÜNLER

006 086 700010	DLFB-R-İŞİN TİPİ BEAM DEDEKTÖR 3-100 MT / SD3	1 ad.		810 €
006 086 700011	DLFB30-R-İŞİN TİPİ BEAM DEDEKTÖR 30MT / SD3	1 ad.		690 €
885 325 000138	NB-138-12VDC-SU BASKIN DEDEKTÖRÜ RÖLE ÇIKIŞI / WIZMART	1 ad.		27 \$
885 325 000606	NB-606-4-SİGARA DUMANI ALGILAMA DEDEKTÖRÜ 24V / WIZMART	1 ad.		55 \$
885 326 002000	FS2000E-DAHİLİ ORTAM ALEV DEDEKTÖRÜ / PULNİX	1 ad.		430 \$
885 326 005000	FS5000E-HARİCİ ORTAM ALEV DEDEKTÖRÜ / PULNİX	1 ad.		810 \$
999 999 000581	NFE-MEKANİK DEPREM SENSÖRÜ	1 ad.		400 \$
999 999 001191	SİSLİFT-2 ELEKTRONİK DEPREM SENSÖRÜ	1 ad.		220 \$
006 086 601044	EWLD-1224 SU BASKIN DEDEKTÖRÜ 12-24V	1 ad.		24 \$

ADRESLİ YANGIN İHBAR PANELLERİ VE AKSESUARLARI

006 086 510240	SAYA 1 LOOP ADRESLİ PANEL 240 ADRES	1 ad.		950 €
006 086 530720	SAYA 3 LOOP ADRESLİ PANEL 720 ADRES	1 ad.		1.650 €
006 086 210001	V2100-1 LOOP ADRESLİ PANEL 240 ADRES / VELOX	1 ad.		1.625 \$
006 086 220002	V2200-2 LOOP ADRESLİ PANEL 480 ADRES / VELOX	1 ad.		2.625 \$
006 086 004021	V2000-RP TEKRARLAMA PANELİ 2000 SERİ PANELLER İÇİN	1 ad.		900 \$
006 086 440033	4400-3L-3 LOOP ADRESLİ PANEL-720 ADRES / VELOX	1 ad.		5.658 \$
006 086 004020	4020-TEKRARLAMA PANELİ 4000 SERİ PANELLER İÇİN / VELOX	1 ad.		2.080 \$
006 086 004420	4420-RS 485 PANELLER NETWORK KARTI / VELOX	1 ad.		550 \$
006 086 500001	S-485 SAYA PANELLER İÇİN NETWORK KARTI	1 ad.		400 €
006 086 511000	SAYA-RP SAYA TEKRARLAMA PANELİ	1 ad.		685 €

ADRESLİ YANGIN İHBAR DEDEKTÖRLERİ

888 888 000100	LV100-ADRESLİ DUMAN DEDEKTÖRÜ / VELOX	1 ad.		39 \$
888 888 000350	LV350-ADRESLİ İSİ DEDEKTÖRÜ / VELOX	1 ad.		39 \$
888 888 000200	LV200-ADRESLİ KOMBİNE DEDEKTÖRÜ / VELOX	1 ad.		45 \$
888 888 040900	40900-ADRESLİ DEDEKTÖR SOKETİ / VELOX	1 ad.		4 \$

YANGIN İHBAR BUTON, SİRENLERİ VE MODÜLLER

888 888 040800	40800-ADRESLİ YANGIN İHBAR BUTONU / VELOX	1 ad.		48 \$
888 888 040300	40300-ADRESLİ SİREN / VELOX	1 ad.		91 \$
888 888 040002	40002-2 Lİ ÇIKIŞ RÖLE MODÜLÜ / VELOX	1 ad.		61 \$
888 888 040010	40010-SİREN KONTROL MODÜLÜ (HARİCEN BESLENİR) / VELOX	1 ad.		74 \$
888 888 040100	40100-TEKLİ GİRİŞ İZLEME MODÜLÜ / VELOX	1 ad.		53 \$
888 888 040102	40102-TEKLİ GİRİŞ (İZLEME) 2'Lİ ÇIKIŞ RÖLE MODÜLÜ / VELOX	1 ad.		88 \$
888 888 040110	40110-TEKLİ GİRİŞ (İZLEME) VE SİREN KONTROL MODÜLÜ / VELOX	1 ad.		85 \$
888 888 040500	40500-KONVANSİYONEL ZON MODÜLÜ / VELOX	1 ad.		173 \$

mavigard



Kod	Açıklama / Stok Cinsi	Amb. (Kutu)	Amb. Birimi	FİYAT
MAXLOGIC SERİSİ KONVANSİYONEL YANGIN ALARM SANTRALLERİ				
006 090 005000	ML-2222 KONVANSİYONEL YANGIN ALARM SANTRALI, 2 BÖLGE			239 \$
006 090 005010	ML-2224 KONVANSİYONEL YANGIN ALARM SANTRALI, 4 BÖLGE			257 \$
006 090 005020	ML-2228 KONVANSİYONEL YANGIN ALARM SANTRALI, 8 BÖLGE			294 \$
006 090 005030	ML-4218 KONVANSİYONEL GAZ ALARM SANTRALI, 8 BÖLGE, 16 RÖLE, CO			734 \$
MAXLOGIC KONVANSİYONEL STANDART YANGIN ALGILAMA DEDEKTÖRLERİ				
006 090 002110	ML-2110 OPTİK DUMAN DEDEKTÖRÜ			21 \$
006 090 002130	ML-2130 SABİT SICAKLIK DEDEKTÖRÜ			19 \$
006 090 002140	ML-2140 MULTİSENSÖR DEDEKTÖRÜ			31 \$
006 090 000140	ML-0140 DEDEKTÖR SOKETİ			5 \$
MAVİGARD KONVANSİYONEL RÖLE ÇIKIŞLI YANGIN ALGILAMA DEDEKTÖRLERİ				
006 090 002100	MGR-2100 OPTİK DUMAN DEDEKTÖRÜ, RÖLE ÇIKIŞLI, 12V DC			21 \$
006 090 002150	MGR-2300 OPTİK DUMAN DEDEKTÖRÜ, RÖLE ÇIKIŞLI, 12V DC			19 \$
006 090 002500	MGR-2500 MULTİSENSÖR DEDEKTÖR (OPTİK DUMAN+SICAKLIK), RÖLE ÇIKIŞLI, 12V DC			31 \$
006 090 003500	MG-3500 DEDEKTÖR SOKETİ (MGR SERİSİ İÇİN)			6 \$
MAXLOGIC KONVANSİYONEL İŞIN (BEAM) TİPİ DUMAN DEDEKTÖRLERİ				
006 090 002170	ML-2170 İŞIN (BEAM) TİPİ DUMAN DEDEKTÖRÜ (ALICI-VERİCİ DAHİL)			990 \$
MAXLOGIC ELEKTRONİK SİREN, FLAŞÖRLÜ SİREN VE AKSESUARLAR				
006 090 002410	ML-2410 ELEKTRONİK SİREN, KIRMIZI, 24V DC			32 \$
006 090 002420	ML-2420 ELEKTRONİK FLAŞÖR, KIRMIZI, 24V DC			35 \$
006 090 002430	ML-2430 FLAŞÖRLÜ ELEKTRONİK SİREN, KIRMIZI, 24V DC			42 \$
006 090 002710	ML-2710 KONVANSİYONEL YANGIN ALARM BUTONU, RESETLENEBİLİR			18,5 \$
006 090 0050710	ML-0710 BUTON KORUYUCU KAPAK			5 \$
GD / GDR / TGDR SERİSİ KONVANSİYONEL GAZ DEDEKTÖRLERİ				
006 090 041224	GDR-1224L LPG (BÜTAN+PROPAN) DEDEKTÖRÜ, 12/24V DC, RÖLE ÇIKIŞLI			44 \$
006 090 051224	GDR-1224M METAN (DOĞALGAZ) DEDEKTÖRÜ, 12/24V DC, RÖLE ÇIKIŞLI			44 \$
006 090 040220	GDR-220L LPG (BÜTAN+PROPAN) DEDEKTÖRÜ, 230V AC, RÖLE ÇIKIŞLI			44 \$
006 090 050220	GDR-220M METAN (DOĞALGAZ) DEDEKTÖRÜ, 230V AC, RÖLE ÇIKIŞLI			44 \$
006 090 050230	GD2R-24EC KARBONMONOKSİT GAZ DEDK. (CO), 24V DC, 2 ALARM SEVİYELİ, ELEKTRO-KİMYASAL RÖLE ÇIKIŞLI			88 \$
006 090 050240	GD2R-220EC KARBONMONOKSİT GAZ DEDK. (CO), 230V AC, 2 ALARM SEVİYELİ, ELEKTRO-KİMYASAL RÖLE ÇIKIŞLI			96 \$
006 090 000120	ML-0120 SIVA ÜSTÜ BAĞLANTI KUTUSU			13,5 \$
MAXLOGIC SERİSİ AKILLI ADRESLİ YANGIN ALARM SANTRALLERİ, 2 ÇEVİRİME KADAR				
006 090 001226	ML-1221 YANGIN ALARM SANTRALI, 1 ÇEVİRİM, 127 ADRES, LİTE MODEL			950 \$
006 090 001227	ML-1222 YANGIN ALARM SANTRALI, 2 ÇEVİRİM, 254 ADRES, LİTE MODEL			1.425 \$
MAXLOGIC SERİSİ AKILLI ADRESLİ YANGIN ALARM SANTRALLERİ, 8 ÇEVİRİME KADAR				
006 090 001228	ML-1230.N YANGIN ALARM SANTRALI, ÇEVİRİMSİZ, NETWORK KARTI DAHİL-TEKRARLAMA PANELİ			1.109 \$
006 090 001231	ML-1231 YANGIN ALARM SANTRALI, 1 ÇEVİRİM, 127 ADRES			1.109 \$
006 090 001232	ML-1232 YANGIN ALARM SANTRALI, 2 ÇEVİRİM, 254 ADRES			1.584 \$
006 090 001239	ML-1231.N YANGIN ALARM SANTRALI, 1 ÇEVİRİM, 127 ADRES, NETWORK KARTI DAHİL			1.425 \$
006 090 001249	ML-1232.N YANGIN ALARM SANTRALI, 2 ÇEVİRİM, 254 ADRES, NETWORK KARTI DAHİL			1.900 \$
MAVİGARD / MAXLOGIC AKILLI ADRESLİ YANGIN ALGILAMA DEDEKTÖRLERİ				
006 090 001110	ML-1110 OPTİK DUMAN DEDEKTÖRÜ			38 \$
006 090 001130	ML-1130 SICAKLIK DEDEKTÖRÜ			38 \$
006 090 001140	ML-1140 MULTİSENSÖR DEDEKTÖRÜ			57 \$
006 090 000140	ML-0140 DEDEKTÖR SOKETİ			5 \$
MAXLOGIC AKILLI ADRESLİ YANGIN ALGILAMA VE ALARM SİSTEMLERİ İÇİN AKSESUARLAR				
006 090 001410	ML-1410 ADRESLİ SİREN			64 \$
006 090 001420	ML-1420 ADRESLİ FLAŞÖR			76 \$
006 090 001430	ML-1430 ADRESLİ FLAŞÖRLÜ SİREN			89 \$
006 090 001710	ML-1710 ADRESLENEBİLİR YANGIN ALARM BUT., RESETLENEBİLİR, MON. KASASI DAHİL			45 \$
006 090 0050710	ML-0710 BUTON KORUYUCU KAPAK			4,5 \$
006 090 001010	ML-1010 MAXLOGIC ADRES PROGRAMLAMA CİHAZI (SADECE ML-122X PANEL VE ML-1613 YAZILIM İLE BERABER SATILIR)			634 \$
006 090 001613	ML-1613 MAXLOGIC LOOP MANAGER LİTE PANEL PROGRAMLAMA YAZILIM (ML-1221 VE ML-1222 İÇİNDİR)			1.267 \$
MAXLOGIC / MAVİGARD AKILLI ADRESLİ GİRİŞ/ÇIKIŞ VE RÖLE KONTROL MODÜLLERİ				
006 090 009500	ML-1361 RÖLE KONTROL MODÜLÜ, 1 ÇIKIŞLI			80 \$
006 090 009510	ML-1362 KONTAK İZLEME MODÜLÜ, 1 GİRİŞLİ			80 \$
006 090 009520	ML-1363 2/1 I/O MODÜLÜ (2 GİRİŞ / 1 ÇIKIŞ)			159 \$
006 090 009530	ML-1366 4/2 I/O MODÜLÜ (4 GİRİŞ / 2 ÇIKIŞ)			222 \$
006 090 009540	ML-1371 SİREN KONTROL MODÜLÜ, 1 ÇIKIŞLI, 24V DC			95 \$
006 090 009550	ML-1372 BÖLGE DENETİM MODÜLÜ, 1 GİRİŞLİ, 24V DC			95 \$
006 090 009560	ML-1390 KISA DEVRE İZOLATÖR MODÜLÜ			47,5 \$
MAXLOGIC AKILLI ADRESLİ İŞIN (BEAM) TİPİ DUMAN DEDEKTÖRLERİ				
006 090 001170	ML-1170 İŞIN (BEAM) TİPİ DUMAN DEDEK. (ALICI-VERİCİ DAHİL)			1.030 \$



ML-222XX



ML-2110

ML-2130

ML-2140



İŞIN (BEAM) TİPİ DUMAN DEDEKTÖRLERİ (ALICI-VERİCİ)



ML-1410

ML-1430

ML-1710+0710



GAZ DEDEKTÖRÜ

ML-0120



TGDR-1224M



ML-122X



ML-1110

ML-1130

ML-1140



ML-136X

ML-1390

ML-137X



ML-1613 LOOPMANAGER +LIFE

* Maxlogic & Mavigard marka geniş ürün yelpazesi ile tüm isteklerinize çözüm olabilmemiz için lütfen irtibata geçiniz.
* ML1221- , ML 1222 Lite serisi panellerin devreye alımı ML1010- adresleme cihazı ve ML1613- programlama yazılımı ile yapılır.

Kod	Açıklama / Stok Cinsi	Amb. (Kutu)	Amb. Birimi	FİYAT
-----	-----------------------	-------------	-------------	-------

TAMER 0,6-1 KV BAKIR İLETKENLER İÇİN REÇİNELİ EK MUFLAR (AYNI KESİTLERDE ALÜMİNYUM MEVCUTTUR.)

052 125 010021	E1 415-E1 425	(4X1,5-4X2,5)	1 ad.	63,45
052 125 010019	E1 404-E1 406	(4X4-4X6)	1 ad.	63,45
052 125 010020	E1 410	(4X10)	1 ad.	98,46
052 125 010022	E1 416	(4X16)	1 ad.	100,63
052 125 010033	E1 31610	(3X16+10)	1 ad.	99,67
052 125 010034	E1 32516	(3X25+16)	1 ad.	104,95
052 125 010035	E1 33516	(3X35+16)	1 ad.	107,12
052 125 010036	E1 35025	(3X50+25)	1 ad.	110,16
052 125 010047	E1 425	(4X25)	1 ad.	112,40
052 125 010048	E1 435	(4X35)	1 ad.	114,81
052 125 010049	E1 450	(4X50)	1 ad.	116,73
052 125 010037	E1 37035	(3X70+35)	1 ad.	183,63
052 125 010038	E1 39550	(3X95+50)	1 ad.	192,28
052 125 010039	E1 31207	(3X120+70)	1 ad.	306,05
052 125 010040	E1 31507	(3X150+70)	1 ad.	319,67
052 125 010041	E1 31859	(3X185+95)	1 ad.	471,89
052 125 010042	E1 32401	(3X240+120)	1 ad.	507,14

TAMER 0,6-1 KV NYN-NYCY KABLolar İÇİN ŞEFFAF REÇİNELİ KABLO EK MUFLARI

052 125 090416	ŞE1 416	(4X16)	1 ad.	96,14
052 125 090425	ŞE1 425	(4X25)	1 ad.	100,63
052 125 091610	ŞE1 31610	(3X16+10)	1 ad.	96,14
052 125 092516	ŞE1 32516	(3X25+16)	1 ad.	98,30
052 125 091012	ŞE1 1015-E1 1025	(3X1,5-10X2,5)	1 ad.	120,18
052 125 090406	ŞE1 1004-E1 1006	(10X4-10X6)	1 ad.	120,18
052 125 090435	ŞE1 435	(4X35)	1 ad.	232,66
052 125 090450	ŞE1 450	(4X50)	1 ad.	232,66
052 125 090470	ŞE1 470	(4X70)	1 ad.	240,99
052 125 090495	ŞE1 495	(4X95)	1 ad.	247,24
052 125 093516	ŞE1 33516	(3X35+16)	1 ad.	230,34
052 125 095025	ŞE1 35025	(3X50+25)	1 ad.	234,74
052 125 097035	ŞE1 37035	(3X70+35)	1 ad.	238,75
052 125 099550	ŞE1 39550	(3X95+50)	1 ad.	243,07
052 125 092412	ŞE1 2415-E1 2425	(24X1,5-24X2,5)	1 ad.	180,42

TAMER T TİP

052 125 050410	TE1 410	(4X10)	1 ad.	262,30
052 125 050416	TE1 416	(4X16)	1 ad.	262,30
052 125 050425	TE1 425	(4X25)	1 ad.	275,44
052 125 051610	TE1 31610	(3X16+10)	1 ad.	262,30
052 125 052516	TE1 32516	(3X25+16)	1 ad.	275,44
052 125 050435	TE1 435	(4X35)	1 ad.	417,57
052 125 050450	TE1 450	(4X50)	1 ad.	421,97
052 125 050470	TE1 470	(4X70)	1 ad.	426,22
052 125 050495	TE1 495	(4X95)	1 ad.	637,73
052 125 053516	TE1 33516	(3X35+16)	1 ad.	415,24
052 125 055025	TE1 35025	(3X50+25)	1 ad.	419,65
052 125 057035	TE1 37035	(3X70+35)	1 ad.	424,30
052 125 059550	TE1 39550	(3X95+50)	1 ad.	629,72
052 125 054120	TE1 4120	(4X120)	1 ad.	648,95
052 125 054150	TE1 4150	(4X150)	1 ad.	656,96
052 125 054185	TE1 4185	(4X185)	1 ad.	664,97
052 125 054240	TE1 4240	(4X240)	1 ad.	672,98
052 125 051207	TE1 31207	(3X120+70)	1 ad.	640,93
052 125 051507	TE1 31507	(3X150+70)	1 ad.	648,95
052 125 051859	TE1 31859	(3X185+95)	1 ad.	656,96
052 125 052401	TE1 32401	(3X240+120)	1 ad.	664,97

TAMER Y TİP KABLO KESİTİ / Y ÇIKIŞ KESİTİ

052 125 061161	YE1 11615	(1X16-1X1,5)	1 ad.	82,36
052 125 061251	YE1 12516	(1X25-1X16)	1 ad.	87,41
052 125 061352	YE1 13525	(1X35-1X25)	1 ad.	87,41

TAMER 0,6-1 KV NYN-NYCY KABLolar İÇİN VİDALI DÜZ TİP ŞEFFAF REÇİNELİ KABLO EK MUFLARI

052 125 080410	VDE1 410	(4X10)	1 ad.	168,25
052 125 080416	VDE1 416	(4X16)	1 ad.	168,25
052 125 080425	VDE1 425	(4X25)	1 ad.	176,26
052 125 081610	VDE1 31610	(3X16+10)	1 ad.	168,25
052 125 082516	VDE1 32516	(3X25+16)	1 ad.	176,26
052 125 080435	VDE1 435	(4X35)	1 ad.	285,22
052 125 080450	VDE1 450	(4X50)	1 ad.	285,22
052 125 080470	VDE1 470	(4X70)	1 ad.	296,43
052 125 083516	VDE1 33516	(3X35+16)	1 ad.	285,22
052 125 085025	VDE1 35025	(3X50+25)	1 ad.	285,22
052 125 087035	VDE1 37035	(3X70+35)	1 ad.	296,43
052 125 080495	VDE1 495	(4X95)	1 ad.	362,13
052 125 084120	VDE1 4120	(4X120)	1 ad.	456,67
052 125 084150	VDE1 4150	(4X150)	1 ad.	512,75
052 125 084185	VDE1 4185	(4X185)	1 ad.	512,75
052 125 084240	VDE1 4240	(4X240)	1 ad.	512,75
052 125 089550	VDE1 39550	(3X95+50)	1 ad.	362,13
052 125 081207	VDE1 31207	(3X120+70)	1 ad.	456,67
052 125 081507	VDE1 31507	(3X150+70)	1 ad.	512,75
052 125 081859	VDE1 31859	(3X185+95)	1 ad.	512,75
052 125 082401	VDE1 32401	(3X240+120)	1 ad.	512,75

Kod	Açıklama / Stok Cinsi	Amb. (Kutu)	Amb. Birimi	FIYAT
-----	-----------------------	-------------	-------------	-------

TAMER 0,6-1 KV NYY-NYCY KABLolar İÇİN VİDALI Y BRANŞMAN TİP ŞEFFAF REÇİNELİ KABLO EK MUFLARI

052 125 100410	VYE1 410	(4X10)	1 ad.	205,10
052 125 100416	VYE1 416	(4X16)	1 ad.	205,10
052 125 100425	VYE1 425	(4X25)	1 ad.	213,11
052 125 101610	VYE1 31610	(3X16+10)	1 ad.	205,10
052 125 102516	VYE1 32516	(3X25+16)	1 ad.	213,11
052 125 100435	VYE1 435	(4X35)	1 ad.	312,46
052 125 100450	VYE1 450	(4X50)	1 ad.	312,46
052 125 100470	VYE1 470	(4X70)	1 ad.	317,26
052 125 103516	VYE1 33516	(3X35+16)	1 ad.	312,46
052 125 105025	VYE1 35025	(3X50+25)	1 ad.	312,46
052 125 107035	VYE1 37035	(3X70+35)	1 ad.	317,26
052 125 100495	VYE1 495	(4X95)	1 ad.	443,85
052 125 104120	VYE1 4120	(4X120)	1 ad.	453,46
052 125 109550	VYE1 39550	(3X95+50)	1 ad.	443,85
052 125 101207	VYE1 31207	(3X120+70)	1 ad.	453,46
052 125 104150	VYE1 4150	(4X150)	1 ad.	767,52
052 125 104185	VYE1 4185	(4X185)	1 ad.	767,52
052 125 104240	VYE1 4240	(4X240)	1 ad.	775,53
052 125 101507	VYE1 31507	(3X150+70)	1 ad.	767,52
052 125 101859	VYE1 31859	(3X185+95)	1 ad.	767,52
052 125 102401	VYE1 32401	(3X240+120)	1 ad.	775,53



TAMER PROTOLİN (REÇİNE)

052 125 030200	PRO 210 GR. PROTOLİN REÇİNE	1 ad.	20,83
052 125 030500	PRO 500 GR. PROTOLİN REÇİNE	1 ad.	34,45
052 125 031000	PRO 1000 GR. PROTOLİN REÇİNE	1 ad.	61,61
052 125 031500	PRO 1500 GR. PROTOLİN REÇİNE	1 ad.	92,78
052 125 033000	PRO 3 KG PROTOLİN REÇİNE	1 ad.	183,47
052 125 030040	PRO 4 KG PROTOLİN REÇİNE	1 ad.	215,51
052 125 030020	PRO 20 KG PROTOLİN REÇİNE	1 ad.	1049,53



TAMER 0,6-1 KV BAKIR İLETKENLER İÇİN ISI BÜZÜŞMELİ EK MUFLARI (AYNI KESİTLERDE ALÜMİNYUM MEVCUTTUR.)

052 125 020011	S1 404-S1 406	(4X4-4X6) ISI BÜZÜŞMELİ	1 ad.	28,60
052 125 020001	S1 410	(4X10) ISI BÜZÜŞMELİ	1 ad.	35,72
052 125 020002	S1 416	(4X16) ISI BÜZÜŞMELİ	1 ad.	37,80
052 125 120425	S1 425	(4X25) ISI BÜZÜŞMELİ	1 ad.	58,37
052 125 120435	S1 435	(4X35) ISI BÜZÜŞMELİ	1 ad.	62,77
052 125 120450	S1 450	(4X50) ISI BÜZÜŞMELİ	1 ad.	62,77
052 125 120470	S1 470	(4X70) ISI BÜZÜŞMELİ	1 ad.	100,65
052 125 120495	S1 495	(4X95) ISI BÜZÜŞMELİ	1 ad.	110,55
052 125 020003	S1 31610	(3X16+10) ISI BÜZÜŞMELİ	1 ad.	37,80
052 125 020004	S1 32616	(3X25+16) ISI BÜZÜŞMELİ	1 ad.	56,43
052 125 020005	S1 33516	(3X35+16) ISI BÜZÜŞMELİ	1 ad.	61,23
052 125 020006	S1 35025	(3X50+25) ISI BÜZÜŞMELİ	1 ad.	66,02
052 125 020007	S1 37035	(3X70+35) ISI BÜZÜŞMELİ	1 ad.	98,87
052 125 020008	S1 39550	(3X95+50) ISI BÜZÜŞMELİ	1 ad.	107,92
052 125 020009	S1 31207	(3X120+70) ISI BÜZÜŞMELİ	1 ad.	140,93
052 125 020027	S1 31507	(3X150+70) ISI BÜZÜŞMELİ	1 ad.	173,78
052 125 020010	S1 31859	(3X185+95) ISI BÜZÜŞMELİ	1 ad.	283,48
052 125 020028	S1 32401	(3X240+120) ISI BÜZÜŞMELİ	1 ad.	296,62
052 125 123315	S1 33001	(3X300+150) ISI BÜZÜŞMELİ	1 ad.	320,59
052 125 123418	S1 34001	(3X400+185) ISI BÜZÜŞMELİ	1 ad.	363,72



TAMER FERMUARLI ISI BÜZÜŞMELİ KABLO EK MUFLARI

052 125 144105	FS1 4105	(4X1,5) FERMUARLI ISI BÜZÜŞMELİ	1 ad.	112,16
052 125 144205	FS1 4205	(4X2,5) FERMUARLI ISI BÜZÜŞMELİ	1 ad.	112,16
052 125 140404	FS1 404	(4X4) FERMUARLI ISI BÜZÜŞMELİ	1 ad.	112,16
052 125 140406	FS1 406	(4X6) FERMUARLI ISI BÜZÜŞMELİ	1 ad.	112,16
052 125 140410	FS1 410	(4X10) FERMUARLI ISI BÜZÜŞMELİ	1 ad.	121,06
052 125 140416	FS1 416	(4X16) FERMUARLI ISI BÜZÜŞMELİ	1 ad.	128,19
052 125 140425	FS1 425	(4X25) FERMUARLI ISI BÜZÜŞMELİ	1 ad.	136,20
052 125 140435	FS1 435	(4X35) FERMUARLI ISI BÜZÜŞMELİ	1 ad.	138,60
052 125 140450	FS1 450	(4X50) FERMUARLI ISI BÜZÜŞMELİ	1 ad.	142,45
052 125 140470	FS1 470	(4X70) FERMUARLI ISI BÜZÜŞMELİ	1 ad.	182,51
052 125 140495	FS1 495	(4X95) FERMUARLI ISI BÜZÜŞMELİ	1 ad.	188,43
052 125 144120	FS1 4120	(4X120) FERMUARLI ISI BÜZÜŞMELİ	1 ad.	224,33
052 125 144150	FS1 4150	(4X150) FERMUARLI ISI BÜZÜŞMELİ	1 ad.	232,34
052 125 144185	FS1 4185	(4X185) FERMUARLI ISI BÜZÜŞMELİ	1 ad.	277,20
052 125 144240	FS1 4240	(4X240) FERMUARLI ISI BÜZÜŞMELİ	1 ad.	304,44
052 125 144300	FS1 4300	(4X300) FERMUARLI ISI BÜZÜŞMELİ	1 ad.	367,74
052 125 144400	FS1 4400	(4X400) FERMUARLI ISI BÜZÜŞMELİ	1 ad.	408,60
052 125 141610	FS1 31610	(3X16+10) FERMUARLI ISI BÜZÜŞMELİ	1 ad.	128,19
052 125 142516	FS1 32516	(3X25+16) FERMUARLI ISI BÜZÜŞMELİ	1 ad.	134,36
052 125 143516	FS1 33516	(3X35+16) FERMUARLI ISI BÜZÜŞMELİ	1 ad.	136,20
052 125 145025	FS1 35025	(3X50+25) FERMUARLI ISI BÜZÜŞMELİ	1 ad.	140,28
052 125 147035	FS1 37035	(3X70+35) FERMUARLI ISI BÜZÜŞMELİ	1 ad.	178,74
052 125 149550	FS1 39550	(3X95+50) FERMUARLI ISI BÜZÜŞMELİ	1 ad.	184,27
052 125 141207	FS1 31207	(3X120+70) FERMUARLI ISI BÜZÜŞMELİ	1 ad.	220,40
052 125 141507	FS1 31507	(3X150+70) FERMUARLI ISI BÜZÜŞMELİ	1 ad.	228,41
052 125 141859	FS1 31859	(3X185+95) FERMUARLI ISI BÜZÜŞMELİ	1 ad.	272,40
052 125 142401	FS1 32401	(3X240+120) FERMUARLI ISI BÜZÜŞMELİ	1 ad.	300,68
052 125 143001	FS1 33001	(3X300+150) FERMUARLI ISI BÜZÜŞMELİ	1 ad.	360,53
052 125 143401	FS1 34001	(3X400+185) FERMUARLI ISI BÜZÜŞMELİ	1 ad.	400,58



Kod	Açıklama / Stok Cinsi	Amb. (Kutu)	Amb. Birimi	FİYAT
-----	-----------------------	-------------	-------------	-------

TAMER 0.6-1 KV A.G. PABUÇSUZ REÇİNELİ KABLO BAŞLIKLARI

052 125 070001	PKB 01 (2X1,5-3X50+25)	1 ad.		25,64
052 125 070002	PKB 02 (3X70+35-3X95+50)	1 ad.		36,85
052 125 070003	PKB 03 (3X120+70-3X150+70)	1 ad.		64,09

TAMER 0.6-1 KV A.G. ÇOK DAMARLI ISI BÜZÜŞMELİ KABLO BAŞLIKLARI 4 DAMARLI PABUÇLU

052 125 184205	IBB1 4205 (4X2,5) 4 DAMARLI PABUÇLU ISI BÜZ.KAB.BAŞLIĞI	1 ad.		99,34
052 125 180404	IBB1 404 (4X4) 4 DAMARLI PABUÇLU ISI BÜZ.KAB.BAŞLIĞI	1 ad.		99,34
052 125 180406	IBB1 406 (4X4) 4 DAMARLI PABUÇLU ISI BÜZ.KAB.BAŞLIĞI	1 ad.		99,34
052 125 180410	IBB1 410 (4X10) 4 DAMARLI PABUÇLU ISI BÜZ.KAB.BAŞLIĞI	1 ad.		100,95
052 125 180416	IBB1 416 (4X16) 4 DAMARLI PABUÇLU ISI BÜZ.KAB.BAŞLIĞI	1 ad.		104,15
052 125 180425	IBB1 425 (4X25) 4 DAMARLI PABUÇLU ISI BÜZ.KAB.BAŞLIĞI	1 ad.		116,97
052 125 180435	IBB1 435 (4X35) 4 DAMARLI PABUÇLU ISI BÜZ.KAB.BAŞLIĞI	1 ad.		124,98
052 125 180450	IBB1 450 (4X50) 4 DAMARLI PABUÇLU ISI BÜZ.KAB.BAŞLIĞI	1 ad.		136,20
052 125 180470	IBB1 470 (4X70) 4 DAMARLI PABUÇLU ISI BÜZ.KAB.BAŞLIĞI	1 ad.		154,63
052 125 180495	IBB1 495 (4X95) 4 DAMARLI PABUÇLU ISI BÜZ.KAB.BAŞLIĞI	1 ad.		165,04
052 125 184120	IBB1 4120 (4X120) 4 DAMARLI PABUÇLU ISI BÜZ.KAB.BAŞLIĞI	1 ad.		190,68
052 125 184150	IBB1 4150 (4X150) 4 DAMARLI PABUÇLU ISI BÜZ.KAB.BAŞLIĞI	1 ad.		201,89
052 125 184185	IBB1 4185 (4X185) 4 DAMARLI PABUÇLU ISI BÜZ.KAB.BAŞLIĞI	1 ad.		237,15
052 125 184240	IBB1 4240 (4X240) 4 DAMARLI PABUÇLU ISI BÜZ.KAB.BAŞLIĞI	1 ad.		259,58

TAMER 4 DAMARLI PABUÇSUZ

052 125 164205	IBBX1 4205 (4X2,5) 4 DAMARLI PABUÇSUZ ISI BÜZ.KAB.BAŞLIĞI	1 ad.		67,30
052 125 160404	IBBX1 404 (4X4) 4 DAMARLI PABUÇSUZ ISI BÜZ.KAB.BAŞLIĞI	1 ad.		67,30
052 125 160406	IBBX1 406 (4X4) 4 DAMARLI PABUÇSUZ ISI BÜZ.KAB.BAŞLIĞI	1 ad.		67,30
052 125 160410	IBBX1 410 (4X10) 4 DAMARLI PABUÇSUZ ISI BÜZ.KAB.BAŞLIĞI	1 ad.		67,30
052 125 160031	IBBX1 416 (4X16) 4 DAMARLI PABUÇSUZ ISI BÜZ.KAB.BAŞLIĞI	1 ad.		67,30
052 125 160032	IBBX1 425 (4X25) 4 DAMARLI PABUÇSUZ ISI BÜZ.KAB.BAŞLIĞI	1 ad.		67,30
052 125 160033	IBBX1 435 (4X35) 4 DAMARLI PABUÇSUZ ISI BÜZ.KAB.BAŞLIĞI	1 ad.		107,36
052 125 160034	IBBX1 450 (4X50) 4 DAMARLI PABUÇSUZ ISI BÜZ.KAB.BAŞLIĞI	1 ad.		107,36
052 125 160035	IBBX1 470 (4X70) 4 DAMARLI PABUÇSUZ ISI BÜZ.KAB.BAŞLIĞI	1 ad.		107,36
052 125 160036	IBBX1 495 (4X95) 4 DAMARLI PABUÇSUZ ISI BÜZ.KAB.BAŞLIĞI	1 ad.		107,36
052 125 160037	IBBX1 4120 (4X120) 4 DAMARLI PABUÇSUZ ISI BÜZ.KAB.BAŞLIĞI	1 ad.		134,60
052 125 160038	IBBX1 4150 (4X150) 4 DAMARLI PABUÇSUZ ISI BÜZ.KAB.BAŞLIĞI	1 ad.		134,60
052 125 160039	IBBX1 4185 (4X185) 4 DAMARLI PABUÇSUZ ISI BÜZ.KAB.BAŞLIĞI	1 ad.		134,60
052 125 160040	IBBX1 4240 (4X240) 4 DAMARLI PABUÇSUZ ISI BÜZ.KAB.BAŞLIĞI	1 ad.		160,23

TAMER ISI BÜZÜŞMELİ BORULAR REÇİNELİ YALITIM BORULARI DARALMA ÖNCESİ(MM) / DARALMA SONRASI(MM) / UZUNLUK(MT)

052 125 300903	TIB-9/3 REÇİNELİ YALITIM BORULARI	9	3	1,2	10,58
052 125 301204	TIB-12/4 REÇİNELİ YALITIM BORULARI	12	4	1,2	25,56
052 125 301605	TIB-16/5 REÇİNELİ YALITIM BORULARI	16	5	1,2	31,25
052 125 302206	TIB-22/6 REÇİNELİ YALITIM BORULARI	22	6	1,2	32,05
052 125 302508	TIB-25/8 REÇİNELİ YALITIM BORULARI	25	8	1,2	37,57
052 125 303310	TIB-33/10 REÇİNELİ YALITIM BORULARI	33	10	1,15	38,94
052 125 304012	TIB-40/12 REÇİNELİ YALITIM BORULARI	40	12	1,15	41,02
052 125 304515	TIB-45/15 REÇİNELİ YALITIM BORULARI	45	15	1,15	52,72
052 125 305418	TIB-54/18 REÇİNELİ YALITIM BORULARI	54	18	1,15	53,52
052 125 306522	TIB-65/22 REÇİNELİ YALITIM BORULARI	65	22	1,15	53,52
052 125 307522	TIB-75/22 REÇİNELİ YALITIM BORULARI	75	22	1,15	62,25
052 125 308030	TIB-80/30 REÇİNELİ YALITIM BORULARI	80	30	1,15	78,43
052 125 309030	TIB-90/30 REÇİNELİ YALITIM BORULARI	90	30	1,15	79,96
052 125 310533	TIB-105/33 REÇİNELİ YALITIM BORULARI	105	33	1,15	90,85
052 125 311534	TIB-115/34 REÇİNELİ YALITIM BORULARI	115	34	1,5	101,35
052 125 312540	TIB-125/40 REÇİNELİ YALITIM BORULARI	125	40	1,5	106,07
052 125 314040	TIB-140/40 REÇİNELİ YALITIM BORULARI	140	40	1,5	122,50
052 125 315050	TIB-150/50 REÇİNELİ YALITIM BORULARI	150	50	1,5	239,55
052 125 317058	TIB-170/58 REÇİNELİ YALITIM BORULARI	170	58	1,5	262,14

TAMER BARA İZOLASYON BORULARI DAR. ÖNCESİ(MM) / DARALMA SON.(MM) / UZUNLUK(MT)

052 125 402107	TAIB-21/7 BARA İZOLASYON BORULARI	21	7	1,15	94,78
052 125 403310	TAIB-33/10 BARA İZOLASYON BORULARI	33	10	1,15	109,12
052 125 403812	TAIB-38/12 RULO BARA İZOLASYON BORULARI	38	12	1,15	115,13
052 125 404517	TAIB-45/17 BARA İZOLASYON BORULARI	45	17	1,15	134,60
052 125 405418	TAIB-54/18 BARA İZOLASYON BORULARI	54	18	1,15	139,64
052 125 406022	TAIB-60/22 BARA İZOLASYON BORULARI	60	22	1,15	139,64
052 125 406522	TAIB-65/22 BARA İZOLASYON BORULARI	65	22	1,15	139,80
052 125 407522	TAIB-75/22 BARA İZOLASYON BORULARI	75	22	1,15	139,64
052 125 409030	TAIB-90/30 BARA İZOLASYON BORULARI	90	30	1,15	166,64
052 125 411040	TAIB-110/40 BARA İZOLASYON BORULARI	110	40	1,15	192,28
052 125 412540	TAIB-125/40 BARA İZOLASYON BORULARI	125	40	1,15	192,28
052 125 414040	TAIB-140/40 BARA İZOLASYON BORULARI	140	40	1,15	192,28
052 125 416050	TAIB-160/50 BARA İZOLASYON BORULARI	160	50	1,15	306,05

TAMER FER. TAMİR BORULARI DARALMA ÖNCESİ(MM) / DARALMA SONRASI(MM) / UZUNLUK(MT)

052 125 503012	TFB-30/12 30 / 12 / 1 FERMUARLI TAMİR BORULARI	30	12	1	48,07 €
052 125 503812	TFB-38/12 38 / 12 / 1 FERMUARLI TAMİR BORULARI	38	12	1	48,07 €
052 125 505018	TFB-50/18 50 / 18 / 1 FERMUARLI TAMİR BORULARI	50	18	1	52,88 €
052 125 506522	TFB-65/22 65 / 22 / 1 FERMUARLI TAMİR BORULARI	65	22	1	59,29 €
052 125 508530	TFB-85/30 85 / 30 / 1 FERMUARLI TAMİR BORULARI	85	30	1	64,89 €
052 125 510045	TFB-100/45 100 / 45 / 1 FERMUARLI TAMİR BORULARI	100	45	1	72,11 €

Kod	Açıklama / Stok Cinsi	Amb. (Kutu)	Amb. Birimi	FIYAT
TAMER YENİLENEBİLİR DÜZ TİP VİDALI ŞEFAF REÇİNELİ EK MUFLARI				
052 125 840001	PSİLDE1 410 4x10			198,69
052 125 840002	PSİLDE1 4164x16			198,69
052 125 840003	PSİLDE1 425 4x25			217,92
052 125 840004	PSİLDE1 316103x16+10			198,69
052 125 840005	PSİLDE1 325163x25+16			217,92
052 125 840006	PSİLDE1 435 4x35			318,86
052 125 840007	PSİLDE1 450 4x50			318,86
052 125 840008	PSİLDE1 470 4x70			318,86
052 125 840009	PSİLDE1 33516 3x35+16			317,26
052 125 840010	PSİLDE1 35025 3x50+25			317,26
052 125 840011	PSİLDE1 37035 3 x 70 + 35			317,26
052 125 840012	PSİLDE1 495 4 x 95			389,37
052 125 840013	PSİLDE1 4120 4 x 120			411,80
052 125 840014	PSİLDE1 4150 4 x 150			488,71
052 125 840015	PSİLDE1 4185 4 x 185			548,00
052 125 840016	PSİLDE1 4240 4 x 240			581,65
052 125 840017	PSİLDE1 39550 3 x 95 + 50			387,76
052 125 840018	PSİLDE1 31207 3 x 120 + 70			410,20
052 125 840019	PSİLDE1 31507 3 x 150 + 70			487,11
052 125 840020	PSİLDE1 31859 3 x 185 + 95			546,40
052 125 840021	PSİLDE1 32401 3 x 240 + 120			580,04

TAMER YENİLENEBİLİR Y TİP VİDALI ŞEFAF REÇİNELİ EK MUFLARI

052 125 850001	PSİLYE1 410 4x10			288,42
052 125 850002	PSİLYE1 416 4x16			288,42
052 125 850003	PSİLYE1 425 4x25			304,44
052 125 850004	PSİLYE1 316103x16+10			288,42
052 125 850005	PSİLYE1 325163x25+16			304,44
052 125 850006	PSİLYE1 435 4x35			429,43
052 125 850007	PSİLYE1 450 4x50			429,43
052 125 850008	PSİLYE1 470 4 x 70			432,63
052 125 850009	PSİLYE1 33516 3x35+16			429,43
052 125 850010	PSİLYE1 35025 3x50+25			429,43
052 125 850011	PSİLYE1 37035 3 x 70 + 35			432,63
052 125 850012	PSİLYE1 495 4 x 95			588,06
052 125 850013	PSİLYE1 4120 4 x 120			592,86
052 125 850014	PSİLYE1 39550 3 x 95 + 50			588,06
052 125 850015	PSİLYE1 31207 3 x 120 + 70			592,86
052 125 850016	PSİLYE1 4150 4 x 150			985,44
052 125 850017	PSİLYE1 4185 4 x 185			985,44
052 125 850018	PSİLYE1 4240 4 x 240			985,44
052 125 850019	PSİLYE1 31507 3 x 150 + 70			990,24
052 125 850020	PSİLYE1 31859 3 x 185 + 95			990,24
052 125 850021	PSİLYE1 32401 3 x 240 + 120			990,24

TAMER YENİLENEBİLİR T TİP VİDALI ŞEFAF REÇİNELİ EK MUFLARI

052 125 860001	PSİLTE1 4120 4X120			522,36
052 125 860002	PSİLTE1 4150 4X150			525,57
052 125 860003	PSİLTE1 4185 4X185			528,77
052 125 860004	PSİLTE1 4240 4X240			531,97
052 125 860005	PSİLTE1 31207 3 x 120 + 70			517,55
052 125 860006	PSİLTE1 31507 3 x 150 + 70			520,76
052 125 860007	PSİLTE1 31859 3 x 185 + 95			523,96
052 125 860008	PSİLTE1 32401 3 x 240 + 120			527,17

TAMER YENİLENEBİLİR ESNEK DOLGULU REÇİNELER

052 125 032500	PSİL 500 GR. PROSİL REÇİNE			41,66
052 125 032000	PSİL 1000 GR. PROSİL REÇİNE			73,71

TAMER UÇ KORUYUCULARI DARALMA ÖNCESİ(MM) / DARALMA SONRASI(MM) / UZUNLUK(MM)

052 125 601105	UK-11/5 11 / 5,5 / 22 UÇ KORUYUCU			10,01
052 125 601607	UK-16/7 16 / 7,5 / 75 UÇ KORUYUCU			12,58
052 125 602510	UK-25/10 25 / 10,5 / 80 UÇ KORUYUCU			13,86
052 125 603216	UK-32/16 32 / 16,5 / 90 UÇ KORUYUCU			15,78
052 125 605026	UK-50/26 50 / 26 / 115 UÇ KORUYUCU			19,23
052 125 607037	UK-70/37 70 / 37 / 120 UÇ KORUYUCU			24,84
052 125 610046	UK-100/46 100 / 46 / 140 UÇ KORUYUCU			29,24
052 125 612057	UK-120/57 120 / 57 / 155 UÇ KORUYUCU			34,45

TAMER AĞ BUŞIĞ KAPAMA

052 125 211631	TBK-01 1kV,1000-1600kVA 2000-3150A			160,23
052 125 211632	TBK-05 1kV, 500-800kVA 1000-1250A			144,21
052 125 211633	TBK-04 1kV, 200-400kVA 630A			128,19
052 125 211634	TBK-06 1kV, 50-160kVA 250A			120,18

TAMER OĞ BUŞIĞ KAPAMA

052 125 800001	TBK-02 36kV,10-1600kVA 250-3150A			192,28
----------------	----------------------------------	--	--	--------

TAMER OĞ VHD İZOLATÖR KAPAMA

052 125 810001	TBK-03 (Borulu)			272,40
052 125 810002	TBK-03 (Borusuz)			208,30

TAMER OĞ HAVAI HAT KAPAMA

052 125 820001	THK-01 Swallow (3)			88,13
052 125 820002	THK-01 Raven(1/0)			88,13
052 125 820003	THK-01 Piegon (3/0)			88,13
052 125 820004	THK-01 Sparrow (2)			88,13
052 125 820005	THK 02 Hawk-477			128,19

TAMER OĞ PARAFUDR KAPAMA

052 125 830001	TPK-01 36kV,10-1600kVA 250-3150A			80,12
----------------	----------------------------------	--	--	-------





Kod	Açıklama / Stok Cinsi	Amb. (Kutu)	Amb. Birimi	FİYAT
ISI İLE DARALAN MAKARONLAR				
065 141 030001	1,5 MM ISI İLE DARALAN MAKARON	200 mt.		0,064 \$
065 141 030002	2,5 MM ISI İLE DARALAN MAKARON	200 mt.		0,086 \$
065 141 030003	3 MM ISI İLE DARALAN MAKARON	200 mt.		0,093 \$
065 141 030004	3,2 MM ISI İLE DARALAN MAKARON	200 mt.		0,093 \$
065 141 030005	3,5 MM ISI İLE DARALAN MAKARON	200 mt.		0,098 \$
065 141 030006	4 MM ISI İLE DARALAN MAKARON	200 mt.		0,117 \$
065 141 030007	4,5 MM ISI İLE DARALAN MAKARON	100 mt.		0,137 \$
065 141 030008	4,8 MM ISI İLE DARALAN MAKARON	100 mt.		0,137 \$
065 141 030009	5 MM ISI İLE DARALAN MAKARON	100 mt.		0,147 \$
065 141 030010	6 MM ISI İLE DARALAN MAKARON	100 mt.		0,166 \$
065 141 030011	6,4 MM ISI İLE DARALAN MAKARON	100 mt.		0,166 \$
065 141 030012	7 MM ISI İLE DARALAN MAKARON	100 mt.		0,205 \$
065 141 030013	8 MM ISI İLE DARALAN MAKARON	100 mt.		0,205 \$
065 141 030014	9,5 MM ISI İLE DARALAN MAKARON	100 mt.		0,215 \$
065 141 030015	10 MM ISI İLE DARALAN MAKARON	100 mt.		0,235 \$
065 141 030016	12,7 MM ISI İLE DARALAN MAKARON	100 mt.		0,264 \$
065 141 030017	13 MM ISI İLE DARALAN MAKARON	100 mt.		0,284 \$
065 141 030018	16 MM ISI İLE DARALAN MAKARON	100 mt.		0,450 \$
065 141 030019	18 MM ISI İLE DARALAN MAKARON	100 mt.		0,606 \$
065 141 030020	19,1 MM ISI İLE DARALAN MAKARON	100 mt.		0,606 \$
065 141 030021	20 MM ISI İLE DARALAN MAKARON	100 mt.		0,733 \$
065 141 030022	22 MM ISI İLE DARALAN MAKARON	100 mt.		0,880 \$
065 141 030023	25 MM ISI İLE DARALAN MAKARON	50 mt.		0,978 \$
065 141 030024	30 MM ISI İLE DARALAN MAKARON	50 mt.		1,271 \$
065 141 030025	35 MM ISI İLE DARALAN MAKARON	25 mt.		1,760 \$
065 141 030026	40 MM ISI İLE DARALAN MAKARON	25 mt.		1,907 \$
065 141 030027	50 MM ISI İLE DARALAN MAKARON	25 mt.		2,689 \$
065 141 030028	60 MM ISI İLE DARALAN MAKARON	20 mt.		3,716 \$
065 141 030029	70 MM ISI İLE DARALAN MAKARON	20 mt.		4,791 \$
065 141 030030	80 MM ISI İLE DARALAN MAKARON	20 mt.		5,573 \$
065 141 030031	90 MM ISI İLE DARALAN MAKARON	20 mt.		5,867 \$
065 141 030032	100 MM ISI İLE DARALAN MAKARON	20 mt.		6,844 \$
065 141 030033	120 MM ISI İLE DARALAN MAKARON	20 mt.		9,778 \$

Mutlusan Plastik Elektrik San ve Tic. A.Ş.

İkitelli Org.San. Bölgesi Mahallesi Enkoop Cad.
No:7 Başakşehir- İstanbul
Tel : +90 (212) 485 05 44 (PBX)
Faks : +90 (212) 485 10 12

Karaköy Şube

Okçumusa Cad. Güneşhan İş Hanı No : 24/10
Karaköy-İstanbul
Tel : +90 (212) 237 06 02 (PBX)
Fax: +90 (212) 237 77 47

Perpa Şube

Perpa Tic. Merkezi. A Blok Kat: 2
No: 9-009 Okmeydanı - İstanbul
Tel : +90 (212) 320 05 78 (PBX)
Fax: +90 (212) 320 05 81



mutlusan.com.tr