

—
2021
02
—

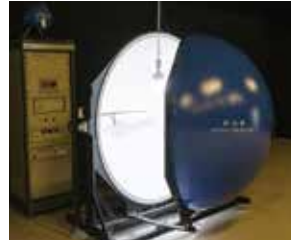

A C K

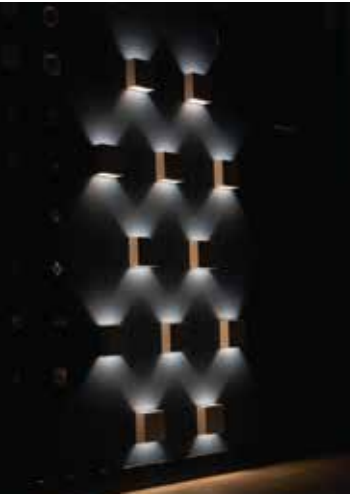

2016 Yılında faaliyete geçen üretim ve depolama alanlarımızın bulunduğu merkez üssümüz 18,000 m2 kapalı alana sahiptir.

1996'dan günümüze



ışığın yeni adı

İÇİNDEKİLER/INDEX

| Ürün Kodu | Sayfa | Fiyat | Ürün Kodu | Sayfa | Fiyat | Ürün Kodu | Sayfa | Fiyat |
|------------|--------|-----------|------------|-------|-----------|------------|-------|-----------|
| 1602-017 | Sf 100 | 4,00 USD | AA24-01550 | Sf 78 | 2,70 USD | AC02-00430 | Sf 73 | 27,50 USD |
| 1602-051 | Sf 100 | 12,00 USD | AA24-01553 | Sf 78 | 2,70 USD | AC04-00134 | Sf 73 | 25,00 USD |
| 5006-005 | Sf 33 | 8,00 USD | AA24-01555 | Sf 78 | 2,70 USD | AC14-00253 | Sf 74 | 12,70 USD |
| 6001-013 | Sf 10 | 6,50 USD | AA24-01558 | Sf 78 | 2,70 USD | AC14-00353 | Sf 74 | 12,70 USD |
| 6001-016 | Sf 10 | 5,75 USD | AA29-00140 | Sf 78 | 4,80 USD | AC14-00453 | Sf 74 | 12,70 USD |
| 6001-017 | Sf 10 | 6,00 USD | AA29-00390 | Sf 78 | 3,20 USD | AC14-00553 | Sf 74 | 12,70 USD |
| 6001-018 | Sf 10 | 8,50 USD | AA29-00393 | Sf 78 | 3,20 USD | AC14-01000 | Sf 74 | 24,15 USD |
| 6095-012 | Sf 10 | 3,60 USD | AA29-00410 | Sf 78 | 4,80 USD | AC15-00609 | Sf 74 | 13,80 USD |
| 6401-021 | Sf 60 | 50,00 USD | AA29-00413 | Sf 78 | 4,80 USD | AC15-61312 | Sf 74 | 38,50 USD |
| 6401-023 | Sf 60 | 50,00 USD | AA29-00440 | Sf 78 | 3,60 USD | AC15-61609 | Sf 74 | 55,00 USD |
| 6401-025 | Sf 60 | 50,00 USD | AA29-30340 | Sf 78 | 2,50 USD | AC15-62609 | Sf 74 | 74,00 USD |
| 6605-001 | Sf 21 | 40,00 USD | AA29-30343 | Sf 78 | 2,50 USD | AC15-63312 | Sf 74 | 44,00 USD |
| 6605-003 | Sf 21 | 40,00 USD | AA29-30440 | Sf 78 | 3,60 USD | AC16-00134 | Sf 66 | 14,00 USD |
| 6801-002 | Sf 21 | 50,00 USD | AA29-30443 | Sf 78 | 3,60 USD | AC16-00135 | Sf 66 | 14,00 USD |
| A05-95-005 | Sf 84 | 3,44 USD | AA31-81420 | Sf 77 | 12,00 USD | AC16-00136 | Sf 66 | 14,00 USD |
| A05-95-006 | Sf 84 | 5,20 USD | AA31-83620 | Sf 20 | 44,00 USD | AC16-00137 | Sf 66 | 14,00 USD |
| A05-95-008 | Sf 84 | 2,64 USD | AA31-83623 | Sf 20 | 44,00 USD | AC16-00138 | Sf 66 | 14,00 USD |
| AA09-00510 | Sf 76 | 2,20 USD | AA31-83626 | Sf 20 | 44,00 USD | AD01-00500 | Sf 33 | 4,35 USD |
| AA09-00511 | Sf 76 | 2,20 USD | AA31-83629 | Sf 20 | 45,00 USD | AD01-00510 | Sf 33 | 4,35 USD |
| AA09-00513 | Sf 76 | 2,20 USD | AA36-00410 | Sf 79 | 3,35 USD | AD01-00530 | Sf 33 | 4,35 USD |
| AA09-00710 | Sf 76 | 2,50 USD | AA36-00610 | Sf 79 | 3,90 USD | AD30-01900 | Sf 58 | 39,00 USD |
| AA09-00711 | Sf 76 | 2,50 USD | AA38-00620 | Sf 79 | 4,50 USD | AD30-01901 | Sf 58 | 39,00 USD |
| AA09-00713 | Sf 76 | 2,50 USD | AA52-00680 | Sf 81 | 5,30 USD | AD30-01910 | Sf 58 | 39,00 USD |
| AA11-00510 | Sf 76 | 2,20 USD | AA52-00681 | Sf 81 | 5,30 USD | AD30-01911 | Sf 58 | 39,00 USD |
| AA11-00511 | Sf 76 | 2,20 USD | AA52-00683 | Sf 81 | 5,30 USD | AD30-01930 | Sf 58 | 39,00 USD |
| AA11-00513 | Sf 76 | 2,20 USD | AA52-01280 | Sf 81 | 7,00 USD | AD30-01931 | Sf 58 | 39,00 USD |
| AA11-00520 | Sf 76 | 2,20 USD | AA52-01281 | Sf 81 | 7,00 USD | AD30-04000 | Sf 58 | 47,00 USD |
| AA11-00521 | Sf 76 | 2,20 USD | AA52-01283 | Sf 81 | 7,00 USD | AD30-04001 | Sf 58 | 47,00 USD |
| AA11-00523 | Sf 76 | 2,20 USD | AA52-01284 | Sf 81 | 8,00 USD | AD30-04010 | Sf 58 | 47,00 USD |
| AA13-00920 | Sf 76 | 2,15 USD | AA52-01285 | Sf 81 | 8,00 USD | AD30-04011 | Sf 58 | 47,00 USD |
| AA13-00921 | Sf 76 | 2,15 USD | AA52-01286 | Sf 81 | 8,00 USD | AD30-04030 | Sf 58 | 47,00 USD |
| AA13-00923 | Sf 76 | 2,15 USD | AA90-00029 | Sf 56 | 16,00 USD | AD30-04031 | Sf 58 | 47,00 USD |
| AA13-01220 | Sf 76 | 2,80 USD | AA90-00129 | Sf 56 | 16,00 USD | AD30-04500 | Sf 59 | 50,00 USD |
| AA13-01221 | Sf 76 | 2,80 USD | AA90-00229 | Sf 56 | 16,00 USD | AD30-04501 | Sf 59 | 50,00 USD |
| AA13-01223 | Sf 76 | 2,80 USD | AA90-00329 | Sf 56 | 16,00 USD | AD30-04510 | Sf 59 | 50,00 USD |
| AA13-01520 | Sf 76 | 3,45 USD | AA90-00429 | Sf 56 | 16,00 USD | AD30-04511 | Sf 59 | 50,00 USD |
| AA13-01521 | Sf 76 | 3,45 USD | AB01-02420 | Sf 81 | 12,50 USD | AD30-04530 | Sf 59 | 50,00 USD |
| AA13-01523 | Sf 76 | 3,45 USD | AB01-12420 | Sf 81 | 12,50 USD | AD30-04531 | Sf 59 | 50,00 USD |
| AA13-02020 | Sf 77 | 5,60 USD | AB01-12423 | Sf 81 | 12,50 USD | AD30-11000 | Sf 58 | 23,00 USD |
| AA13-02023 | Sf 77 | 5,60 USD | AB01-43220 | Sf 81 | 17,00 USD | AD30-11001 | Sf 58 | 23,00 USD |
| AA13-03020 | Sf 77 | 10,80 USD | AB01-52420 | Sf 81 | 12,50 USD | AD30-11010 | Sf 58 | 23,00 USD |
| AA13-03023 | Sf 77 | 10,80 USD | AB01-53220 | Sf 81 | 17,00 USD | AD30-11011 | Sf 58 | 23,00 USD |
| AA13-04020 | Sf 77 | 14,40 USD | AB01-53223 | Sf 81 | 17,00 USD | AD30-11030 | Sf 58 | 23,00 USD |
| AA13-04023 | Sf 77 | 14,40 USD | AB01-62420 | Sf 81 | 12,50 USD | AD30-11031 | Sf 58 | 23,00 USD |
| AA13-05020 | Sf 77 | 19,20 USD | AB01-63220 | Sf 81 | 17,00 USD | AD30-11900 | Sf 58 | 60,00 USD |
| AA13-05023 | Sf 77 | 19,20 USD | AB01-63223 | Sf 81 | 17,00 USD | AD30-11901 | Sf 58 | 48,00 USD |
| AA13-06020 | Sf 77 | 25,20 USD | AB46-00420 | Sf 79 | 5,50 USD | AD30-11910 | Sf 58 | 60,00 USD |
| AA13-06023 | Sf 77 | 25,20 USD | AB47-00420 | Sf 79 | 7,80 USD | AD30-11911 | Sf 58 | 60,00 USD |
| AA14-01020 | Sf 77 | 5,40 USD | AB48-00420 | Sf 79 | 10,00 USD | AD30-11930 | Sf 58 | 60,00 USD |
| AA14-01023 | Sf 77 | 5,40 USD | AB50-00420 | Sf 79 | 11,00 USD | AD30-11931 | Sf 58 | 60,00 USD |
| AA14-20920 | Sf 77 | 4,40 USD | AB53-00420 | Sf 79 | 11,00 USD | AD30-14600 | Sf 59 | 60,00 USD |
| AA14-20921 | Sf 77 | 4,40 USD | AB55-00420 | Sf 79 | 10,00 USD | AD30-14601 | Sf 59 | 60,00 USD |
| AA14-20923 | Sf 77 | 4,40 USD | AB56-00420 | Sf 80 | 10,00 USD | AD30-14610 | Sf 59 | 60,00 USD |
| AA14-60920 | Sf 80 | 17,20 USD | AB57-00420 | Sf 80 | 10,00 USD | AD30-14611 | Sf 59 | 60,00 USD |
| AA24-00560 | Sf 77 | 2,90 USD | AB58-00420 | Sf 80 | 13,20 USD | AD30-14630 | Sf 59 | 60,00 USD |
| AA24-00563 | Sf 77 | 2,90 USD | AB59-00420 | Sf 80 | 13,20 USD | AD30-14631 | Sf 59 | 60,00 USD |
| AA24-00750 | Sf 78 | 2,76 USD | AC01-00130 | Sf 73 | 15,60 USD | AD30-14700 | Sf 59 | 60,00 USD |
| AA24-00751 | Sf 78 | 2,76 USD | AC01-00330 | Sf 73 | 23,80 USD | AD30-14701 | Sf 59 | 60,00 USD |
| AA24-00753 | Sf 78 | 2,76 USD | AC01-00430 | Sf 73 | 42,20 USD | AD30-14710 | Sf 59 | 60,00 USD |

İÇİNDEKİLER/INDEX

| Ürün Kodu | Sayfa | Fiyat | Ürün Kodu | Sayfa | Fiyat | Ürün Kodu | Sayfa | Fiyat |
|------------|-------|------------|------------|-------|------------|------------|--------|-----------|
| AD30-14711 | Sf 59 | 60,00 USD | AG43-02302 | Sf 43 | 142,00 USD | AG57-01021 | Sf 54 | 20,00 USD |
| AD30-14730 | Sf 59 | 60,00 USD | AG43-02702 | Sf 42 | 104,00 USD | AG57-01121 | Sf 54 | 22,00 USD |
| AD30-14731 | Sf 59 | 60,00 USD | AG43-02902 | Sf 42 | 109,00 USD | AG57-02021 | Sf 54 | 19,00 USD |
| AD30-14800 | Sf 59 | 62,00 USD | AG43-03002 | Sf 42 | 122,00 USD | AG57-02121 | Sf 54 | 16,00 USD |
| AD30-14801 | Sf 59 | 62,00 USD | AG43-03202 | Sf 42 | 142,00 USD | AG57-03021 | Sf 54 | 32,00 USD |
| AD30-14810 | Sf 59 | 62,00 USD | AG45-01600 | Sf 85 | 53,00 USD | AG57-03121 | Sf 54 | 60,00 USD |
| AD30-14811 | Sf 59 | 62,00 USD | AG45-04000 | Sf 85 | 75,00 USD | AH01-01053 | Sf 100 | 9,00 USD |
| AD30-14830 | Sf 59 | 62,00 USD | AG50-06301 | Sf 49 | 16,80 USD | AH01-01065 | Sf 100 | 9,00 USD |
| AD30-14831 | Sf 59 | 62,00 USD | AG50-06321 | Sf 49 | 16,80 USD | AH01-01076 | Sf 100 | 12,00 USD |
| AD30-24600 | Sf 59 | 70,00 USD | AG50-06401 | Sf 49 | 25,00 USD | AH01-01085 | Sf 100 | 12,00 USD |
| AD30-24601 | Sf 59 | 70,00 USD | AG50-06421 | Sf 49 | 25,00 USD | AH01-01105 | Sf 100 | 13,00 USD |
| AD30-24610 | Sf 59 | 70,00 USD | AG55-01021 | Sf 55 | 18,00 USD | AH01-01113 | Sf 100 | 3,80 USD |
| AD30-24611 | Sf 59 | 70,00 USD | AG55-01121 | Sf 55 | 18,00 USD | AH01-01123 | Sf 100 | 3,80 USD |
| AD30-24630 | Sf 59 | 70,00 USD | AG55-01221 | Sf 55 | 55,00 USD | AH01-02044 | Sf 99 | 18,00 USD |
| AD30-24631 | Sf 59 | 70,00 USD | AG55-02021 | Sf 55 | 18,00 USD | AH01-02046 | Sf 99 | 18,00 USD |
| AD36-00300 | Sf 63 | 51,00 USD | AG55-02121 | Sf 55 | 18,00 USD | AH01-02054 | Sf 99 | 28,00 USD |
| AD36-00310 | Sf 63 | 51,00 USD | AG55-02221 | Sf 55 | 55,00 USD | AH01-02056 | Sf 99 | 28,00 USD |
| AD36-00330 | Sf 63 | 51,00 USD | AG55-02227 | Sf 55 | 55,00 USD | AH01-02076 | Sf 99 | 13,00 USD |
| AD36-00400 | Sf 63 | 51,00 USD | AG55-03021 | Sf 55 | 18,00 USD | AH01-02084 | Sf 99 | 18,00 USD |
| AD36-00410 | Sf 63 | 51,00 USD | AG55-03121 | Sf 55 | 18,00 USD | AH01-02094 | Sf 99 | 16,00 USD |
| AD36-00430 | Sf 63 | 51,00 USD | AG55-03221 | Sf 55 | 18,00 USD | AH01-02096 | Sf 99 | 16,00 USD |
| AD36-00600 | Sf 62 | 85,00 USD | AG55-03321 | Sf 55 | 28,00 USD | AH01-02104 | Sf 99 | 16,00 USD |
| AD36-00610 | Sf 62 | 85,00 USD | AG55-03421 | Sf 55 | 18,00 USD | AH01-02113 | Sf 99 | 18,00 USD |
| AD36-00630 | Sf 62 | 85,00 USD | AG55-04021 | Sf 51 | 14,60 USD | AH01-02123 | Sf 99 | 18,00 USD |
| AD36-01300 | Sf 62 | 73,00 USD | AG55-04121 | Sf 51 | 16,40 USD | AH01-02133 | Sf 99 | 18,00 USD |
| AD36-01310 | Sf 62 | 73,00 USD | AG55-04221 | Sf 51 | 16,40 USD | AH01-04016 | Sf 94 | 17,00 USD |
| AD36-01330 | Sf 62 | 73,00 USD | AG55-04321 | Sf 51 | 16,00 USD | AH01-04046 | Sf 94 | 17,00 USD |
| AD90-00020 | Sf 60 | 13,00 USD | AG55-04421 | Sf 51 | 32,00 USD | AH01-04056 | Sf 94 | 17,00 USD |
| AD90-00021 | Sf 60 | 13,00 USD | AG55-05021 | Sf 52 | 14,40 USD | AH01-04066 | Sf 94 | 17,00 USD |
| AD90-00023 | Sf 60 | 13,00 USD | AG55-05121 | Sf 52 | 14,60 USD | AH01-04076 | Sf 94 | 17,00 USD |
| AD90-00050 | Sf 60 | 14,00 USD | AG55-05321 | Sf 52 | 31,00 USD | AH01-04086 | Sf 94 | 17,00 USD |
| AD90-00051 | Sf 60 | 14,00 USD | AG55-06021 | Sf 56 | 33,00 USD | AH01-04096 | Sf 94 | 17,00 USD |
| AG31-00122 | Sf 47 | 50,00 USD | AG55-07021 | Sf 56 | 36,00 USD | AH01-04106 | Sf 94 | 17,00 USD |
| AG31-00132 | Sf 47 | 82,00 USD | AG55-08021 | Sf 56 | 43,00 USD | AH02-00133 | Sf 98 | 16,00 USD |
| AG36-00002 | Sf 44 | 84,00 USD | AG55-09001 | Sf 56 | 33,00 USD | AH02-00206 | Sf 98 | 10,50 USD |
| AG36-00012 | Sf 44 | 58,00 USD | AG55-09101 | Sf 56 | 68,00 USD | AH02-00233 | Sf 98 | 10,50 USD |
| AG36-00032 | Sf 44 | 54,00 USD | AG56-01050 | Sf 53 | 10,80 USD | AH02-01006 | Sf 98 | 8,00 USD |
| AG36-00042 | Sf 44 | 75,00 USD | AG56-01055 | Sf 53 | 10,80 USD | AH02-01133 | Sf 98 | 9,00 USD |
| AG36-00062 | Sf 44 | 95,00 USD | AG56-01056 | Sf 53 | 10,80 USD | AH02-01533 | Sf 98 | 15,00 USD |
| AG39-00101 | Sf 66 | 48,00 USD | AG56-01057 | Sf 53 | 10,80 USD | AH02-01733 | Sf 98 | 9,00 USD |
| AG39-00201 | Sf 66 | 48,00 USD | AG56-02020 | Sf 53 | 21,00 USD | AH03-06110 | Sf 63 | 50,00 USD |
| AG40-00102 | Sf 46 | 90,00 USD | AG56-02025 | Sf 53 | 21,00 USD | AH03-26110 | Sf 63 | 52,00 USD |
| AG40-00302 | Sf 46 | 81,00 USD | AG56-02026 | Sf 53 | 21,00 USD | AH03-04010 | Sf 18 | 5,70 USD |
| AG40-00502 | Sf 46 | 85,00 USD | AG56-02027 | Sf 53 | 21,00 USD | AH03-04011 | Sf 19 | 7,00 USD |
| AG40-00602 | Sf 46 | 125,00 USD | AG56-03021 | Sf 56 | 22,00 USD | AH03-04020 | Sf 18 | 5,70 USD |
| AG40-00702 | Sf 46 | 71,00 USD | AG56-04021 | Sf 50 | 25,00 USD | AH03-04021 | Sf 19 | 7,00 USD |
| AG40-00802 | Sf 46 | 92,00 USD | AG56-04121 | Sf 50 | 14,40 USD | AH03-04030 | Sf 18 | 5,50 USD |
| AG40-00902 | Sf 45 | 60,00 USD | AG56-04221 | Sf 50 | 20,80 USD | AH03-04040 | Sf 18 | 5,50 USD |
| AG40-01002 | Sf 45 | 81,00 USD | AG56-04321 | Sf 50 | 14,60 USD | AH03-04041 | Sf 19 | 7,00 USD |
| AG40-01102 | Sf 45 | 121,00 USD | AG56-04421 | Sf 49 | 10,80 USD | AH03-04050 | Sf 18 | 5,50 USD |
| AG40-01202 | Sf 45 | 110,00 USD | AG56-05021 | Sf 50 | 13,00 USD | AH03-04051 | Sf 19 | 7,00 USD |
| AG40-01302 | Sf 45 | 114,00 USD | AG56-05121 | Sf 50 | 12,00 USD | AH03-04060 | Sf 18 | 5,50 USD |
| AG40-01402 | Sf 47 | 110,00 USD | AG56-05221 | Sf 50 | 13,00 USD | AH03-04070 | Sf 18 | 7,00 USD |
| AG40-01502 | Sf 47 | 92,00 USD | AG56-05421 | Sf 50 | 27,00 USD | AH03-04071 | Sf 19 | 8,30 USD |
| AG40-01602 | Sf 48 | 26,40 USD | AG56-06021 | Sf 49 | 27,00 USD | AH03-04080 | Sf 18 | 7,00 USD |
| AG40-01632 | Sf 48 | 26,40 USD | AG56-06050 | Sf 52 | 14,40 USD | AH03-04081 | Sf 19 | 8,30 USD |
| AG43-01802 | Sf 43 | 104,00 USD | AG56-06121 | Sf 49 | 19,20 USD | AH03-05000 | Sf 20 | 3,90 USD |
| AG43-02002 | Sf 43 | 109,00 USD | AG56-06150 | Sf 52 | 20,80 USD | AH03-05001 | Sf 20 | 3,90 USD |
| AG43-02102 | Sf 43 | 115,00 USD | AG56-06221 | Sf 49 | 14,40 USD | AH03-05009 | Sf 20 | 3,90 USD |

İÇİNDEKİLER/INDEX

| Ürün Kodu | Sayfa | Fiyat | Ürün Kodu | Sayfa | Fiyat | Ürün Kodu | Sayfa | Fiyat |
|------------|-------|------------|------------|-------|-----------|------------|-------|-----------|
| AH03-06000 | Sf 63 | 50,00 USD | AH04-01227 | Sf 95 | 15,00 USD | AH07-00604 | Sf 41 | 18,70 USD |
| AH03-06001 | Sf 63 | 50,00 USD | AH04-01229 | Sf 97 | 15,00 USD | AH07-00634 | Sf 41 | 18,70 USD |
| AH03-06010 | Sf 63 | 50,00 USD | AH04-01233 | Sf 98 | 12,00 USD | AH07-00664 | Sf 41 | 18,70 USD |
| AH03-06011 | Sf 63 | 50,00 USD | AH04-01235 | Sf 97 | 15,00 USD | AH07-00704 | Sf 41 | 14,50 USD |
| AH03-06030 | Sf 63 | 50,00 USD | AH04-01236 | Sf 97 | 15,00 USD | AH07-00734 | Sf 41 | 14,50 USD |
| AH03-06031 | Sf 63 | 50,00 USD | AH04-01247 | Sf 97 | 15,00 USD | AH07-00764 | Sf 41 | 14,50 USD |
| AH03-06100 | Sf 63 | 50,00 USD | AH04-01257 | Sf 97 | 15,00 USD | AH07-00804 | Sf 41 | 18,70 USD |
| AH03-06101 | Sf 63 | 50,00 USD | AH04-01266 | Sf 97 | 15,00 USD | AH07-00834 | Sf 41 | 18,70 USD |
| AH03-06111 | Sf 63 | 50,00 USD | AH04-01276 | Sf 96 | 15,00 USD | AH07-00864 | Sf 41 | 18,70 USD |
| AH03-06130 | Sf 63 | 50,00 USD | AH04-01280 | Sf 96 | 15,00 USD | AH07-00904 | Sf 41 | 14,50 USD |
| AH03-06131 | Sf 63 | 50,00 USD | AH04-01285 | Sf 96 | 15,00 USD | AH07-00934 | Sf 41 | 14,50 USD |
| AH03-07100 | Sf 63 | 100,00 USD | AH04-01286 | Sf 96 | 15,00 USD | AH07-00964 | Sf 41 | 14,50 USD |
| AH03-07101 | Sf 63 | 100,00 USD | AH04-01296 | Sf 96 | 15,00 USD | AH07-01004 | Sf 41 | 18,70 USD |
| AH03-07110 | Sf 63 | 100,00 USD | AH04-01303 | Sf 98 | 15,00 USD | AH07-01034 | Sf 41 | 18,70 USD |
| AH03-07111 | Sf 63 | 100,00 USD | AH04-01306 | Sf 98 | 15,00 USD | AH07-01064 | Sf 41 | 18,70 USD |
| AH03-07130 | Sf 63 | 100,00 USD | AH04-01316 | Sf 98 | 15,00 USD | AH07-01104 | Sf 41 | 14,50 USD |
| AH03-07131 | Sf 63 | 100,00 USD | AH04-01326 | Sf 95 | 15,00 USD | AH07-01134 | Sf 41 | 14,50 USD |
| AH03-26000 | Sf 63 | 52,00 USD | AH04-01336 | Sf 98 | 15,00 USD | AH07-01164 | Sf 41 | 14,50 USD |
| AH03-26001 | Sf 63 | 52,00 USD | AH04-01345 | Sf 97 | 15,00 USD | AH07-01204 | Sf 68 | 5,10 USD |
| AH03-26010 | Sf 63 | 52,00 USD | AH04-01346 | Sf 97 | 15,00 USD | AH07-01234 | Sf 68 | 5,10 USD |
| AH03-26011 | Sf 63 | 52,00 USD | AH04-01347 | Sf 97 | 15,00 USD | AH07-01334 | Sf 70 | 8,00 USD |
| AH03-26030 | Sf 63 | 52,00 USD | AH05-00403 | Sf 69 | 12,00 USD | AH07-01344 | Sf 70 | 8,00 USD |
| AH03-26031 | Sf 63 | 52,00 USD | AH05-00503 | Sf 69 | 12,00 USD | AH07-01354 | Sf 70 | 8,00 USD |
| AH03-26100 | Sf 63 | 52,00 USD | AH05-00533 | Sf 69 | 12,00 USD | AH07-01364 | Sf 70 | 8,00 USD |
| AH03-26101 | Sf 63 | 52,00 USD | AH05-00703 | Sf 69 | 12,00 USD | AH07-01400 | Sf 65 | 13,20 USD |
| AH03-26111 | Sf 63 | 52,00 USD | AH05-00803 | Sf 70 | 11,80 USD | AH07-01401 | Sf 65 | 13,20 USD |
| AH03-26130 | Sf 63 | 52,00 USD | AH05-00833 | Sf 70 | 11,80 USD | AH07-01403 | Sf 69 | 12,90 USD |
| AH03-26131 | Sf 63 | 52,00 USD | AH05-00843 | Sf 70 | 11,80 USD | AH07-01700 | Sf 68 | 5,85 USD |
| AH03-27100 | Sf 63 | 104,00 USD | AH05-00853 | Sf 70 | 11,80 USD | AH07-01701 | Sf 68 | 5,85 USD |
| AH03-27101 | Sf 63 | 104,00 USD | AH05-00863 | Sf 70 | 11,80 USD | AH07-01710 | Sf 68 | 5,85 USD |
| AH03-27110 | Sf 63 | 104,00 USD | AH06-00001 | Sf 19 | 12,00 USD | AH07-01711 | Sf 68 | 5,85 USD |
| AH03-27111 | Sf 63 | 104,00 USD | AH06-00011 | Sf 19 | 12,00 USD | AH07-01730 | Sf 68 | 5,85 USD |
| AH03-27130 | Sf 63 | 104,00 USD | AH06-00031 | Sf 19 | 12,00 USD | AH07-01731 | Sf 68 | 5,85 USD |
| AH03-27131 | Sf 63 | 104,00 USD | AH06-00100 | Sf 68 | 5,85 USD | AH07-02051 | Sf 48 | 16,20 USD |
| AH03-90001 | Sf 20 | 0,81 USD | AH06-00101 | Sf 68 | 5,85 USD | AH07-02151 | Sf 48 | 22,80 USD |
| AH04-01016 | Sf 94 | 15,00 USD | AH06-00110 | Sf 68 | 5,85 USD | AH07-03001 | Sf 66 | 28,00 USD |
| AH04-01026 | Sf 94 | 15,00 USD | AH06-00111 | Sf 68 | 5,85 USD | AH07-03200 | Sf 64 | 22,00 USD |
| AH04-01037 | Sf 94 | 15,00 USD | AH06-00130 | Sf 68 | 5,85 USD | AH07-03201 | Sf 64 | 22,00 USD |
| AH04-01047 | Sf 94 | 15,00 USD | AH06-00131 | Sf 68 | 5,85 USD | AH07-03210 | Sf 64 | 22,00 USD |
| AH04-01051 | Sf 95 | 15,00 USD | AH06-00204 | Sf 69 | 6,60 USD | AH07-03211 | Sf 64 | 22,00 USD |
| AH04-01066 | Sf 95 | 15,00 USD | AH06-00234 | Sf 69 | 6,60 USD | AH07-03230 | Sf 64 | 22,00 USD |
| AH04-01076 | Sf 95 | 15,00 USD | AH06-00300 | Sf 68 | 5,85 USD | AH07-03231 | Sf 64 | 22,00 USD |
| AH04-01106 | Sf 95 | 15,00 USD | AH06-00301 | Sf 68 | 5,85 USD | AH07-03300 | Sf 64 | 28,60 USD |
| AH04-01115 | Sf 95 | 15,00 USD | AH06-00304 | Sf 69 | 5,40 USD | AH07-03301 | Sf 64 | 28,60 USD |
| AH04-01116 | Sf 95 | 15,00 USD | AH06-00310 | Sf 68 | 5,85 USD | AH07-03310 | Sf 64 | 28,60 USD |
| AH04-01117 | Sf 95 | 15,00 USD | AH06-00311 | Sf 68 | 5,85 USD | AH07-03311 | Sf 64 | 28,60 USD |
| AH04-01135 | Sf 96 | 15,00 USD | AH06-00330 | Sf 68 | 5,85 USD | AH07-03330 | Sf 64 | 28,60 USD |
| AH04-01136 | Sf 96 | 15,00 USD | AH06-00331 | Sf 68 | 5,85 USD | AH07-03331 | Sf 64 | 28,60 USD |
| AH04-01146 | Sf 95 | 15,00 USD | AH06-00403 | Sf 70 | 9,60 USD | AH07-03500 | Sf 64 | 28,80 USD |
| AH04-01156 | Sf 96 | 15,00 USD | AH06-00433 | Sf 70 | 9,60 USD | AH07-03501 | Sf 64 | 28,80 USD |
| AH04-01160 | Sf 95 | 15,00 USD | AH06-00500 | Sf 69 | 6,60 USD | AH07-03700 | Sf 64 | 36,00 USD |
| AH04-01161 | Sf 96 | 15,00 USD | AH06-00530 | Sf 69 | 6,60 USD | AH07-03701 | Sf 64 | 36,00 USD |
| AH04-01165 | Sf 96 | 15,00 USD | AH06-00730 | Sf 69 | 18,00 USD | AH07-03710 | Sf 64 | 36,00 USD |
| AH04-01177 | Sf 96 | 15,00 USD | AH06-00850 | Sf 33 | 5,50 USD | AH07-03711 | Sf 64 | 36,00 USD |
| AH04-01179 | Sf 96 | 15,00 USD | AH06-00936 | Sf 70 | 6,60 USD | AH07-03730 | Sf 64 | 36,00 USD |
| AH04-01186 | Sf 97 | 15,00 USD | AH06-01200 | Sf 70 | 10,00 USD | AH07-03731 | Sf 64 | 36,00 USD |
| AH04-01196 | Sf 97 | 15,00 USD | AH06-01230 | Sf 70 | 10,00 USD | AH07-04001 | Sf 65 | 16,80 USD |
| AH04-01206 | Sf 97 | 15,00 USD | AH07-00100 | Sf 70 | 15,60 USD | AH07-04101 | Sf 65 | 16,80 USD |
| AH04-01216 | Sf 95 | 15,00 USD | AH07-00130 | Sf 70 | 15,60 USD | AH07-04201 | Sf 65 | 16,80 USD |

İÇİNDEKİLER/INDEX

| Ürün Kodu | Sayfa | Fiyat | Ürün Kodu | Sayfa | Fiyat | Ürün Kodu | Sayfa | Fiyat |
|------------|-------|------------|------------|-------|-----------|------------|-------|------------|
| AH07-04301 | Sf 65 | 28,80 USD | AH12-01571 | Sf 71 | 11,50 USD | AH17-02471 | Sf 89 | 27,00 USD |
| AH07-04401 | Sf 66 | 26,40 USD | AH12-02500 | Sf 71 | 17,25 USD | AH17-02670 | Sf 88 | 28,00 USD |
| AH07-04501 | Sf 65 | 26,40 USD | AH12-02501 | Sf 71 | 17,25 USD | AH17-02671 | Sf 88 | 28,00 USD |
| AH07-04601 | Sf 65 | 26,40 USD | AH12-02510 | Sf 71 | 17,25 USD | AH17-02770 | Sf 87 | 27,00 USD |
| AH07-04701 | Sf 65 | 26,40 USD | AH12-02511 | Sf 71 | 17,25 USD | AH17-02771 | Sf 87 | 27,00 USD |
| AH07-04801 | Sf 65 | 25,80 USD | AH12-02560 | Sf 71 | 17,25 USD | AH17-02870 | Sf 86 | 68,00 USD |
| AH07-05001 | Sf 67 | 10,80 USD | AH12-02561 | Sf 71 | 17,25 USD | AH17-02871 | Sf 86 | 68,00 USD |
| AH07-05031 | Sf 67 | 10,80 USD | AH12-02570 | Sf 71 | 17,25 USD | AH17-02970 | Sf 86 | 68,00 USD |
| AH07-05101 | Sf 67 | 10,80 USD | AH12-02571 | Sf 71 | 17,25 USD | AH17-02971 | Sf 86 | 68,00 USD |
| AH07-05201 | Sf 67 | 10,80 USD | AH12-03500 | Sf 71 | 23,00 USD | AH17-03070 | Sf 86 | 95,00 USD |
| AH07-05300 | Sf 68 | 26,50 USD | AH12-03501 | Sf 71 | 23,00 USD | AH17-03071 | Sf 86 | 95,00 USD |
| AH07-05330 | Sf 68 | 26,50 USD | AH12-03510 | Sf 71 | 23,00 USD | AH17-03170 | Sf 86 | 126,00 USD |
| AH07-05431 | Sf 68 | 26,50 USD | AH12-03511 | Sf 71 | 23,00 USD | AH17-03171 | Sf 86 | 126,00 USD |
| AH07-05530 | Sf 68 | 24,00 USD | AH12-03560 | Sf 71 | 23,00 USD | AH17-03270 | Sf 88 | 33,00 USD |
| AH08-00603 | Sf 21 | 79,00 USD | AH12-03561 | Sf 71 | 23,00 USD | AH17-03271 | Sf 88 | 33,00 USD |
| AH08-00633 | Sf 21 | 79,00 USD | AH12-03570 | Sf 71 | 23,00 USD | AH17-03570 | Sf 87 | 31,00 USD |
| AH08-00653 | Sf 21 | 79,00 USD | AH12-03571 | Sf 71 | 23,00 USD | AH17-03571 | Sf 87 | 31,00 USD |
| AH08-00663 | Sf 21 | 79,00 USD | AH12-04500 | Sf 71 | 32,50 USD | AH17-03670 | Sf 87 | 87,00 USD |
| AH08-00693 | Sf 21 | 81,00 USD | AH12-04501 | Sf 71 | 32,50 USD | AH17-03671 | Sf 87 | 87,00 USD |
| AH08-00900 | Sf 21 | 80,00 USD | AH12-04510 | Sf 71 | 32,50 USD | AH17-03770 | Sf 87 | 94,00 USD |
| AH08-00901 | Sf 21 | 80,00 USD | AH12-04511 | Sf 71 | 32,50 USD | AH17-03771 | Sf 87 | 94,00 USD |
| AH08-00930 | Sf 21 | 80,00 USD | AH12-04560 | Sf 71 | 32,50 USD | AH17-03870 | Sf 89 | 100,00 USD |
| AH08-00931 | Sf 21 | 80,00 USD | AH12-04561 | Sf 71 | 32,50 USD | AH17-03871 | Sf 89 | 100,00 USD |
| AH08-00950 | Sf 21 | 80,00 USD | AH12-04570 | Sf 71 | 32,50 USD | AH17-03970 | Sf 88 | 123,00 USD |
| AH08-00951 | Sf 21 | 80,00 USD | AH12-04571 | Sf 71 | 32,50 USD | AH17-03971 | Sf 88 | 123,00 USD |
| AH08-00960 | Sf 21 | 80,00 USD | AH13-05600 | Sf 20 | 34,70 USD | AH17-04070 | Sf 86 | 115,00 USD |
| AH08-00961 | Sf 21 | 80,00 USD | AH17-00170 | Sf 87 | 28,00 USD | AH17-04071 | Sf 86 | 115,00 USD |
| AH08-00990 | Sf 21 | 81,00 USD | AH17-00171 | Sf 87 | 28,00 USD | AH17-04170 | Sf 88 | 97,00 USD |
| AH08-00991 | Sf 21 | 81,00 USD | AH17-00270 | Sf 86 | 28,00 USD | AH17-04171 | Sf 88 | 97,00 USD |
| AH08-01203 | Sf 21 | 142,00 USD | AH17-00271 | Sf 86 | 28,00 USD | AH17-04270 | Sf 86 | 48,00 USD |
| AH08-01233 | Sf 21 | 142,00 USD | AH17-00370 | Sf 86 | 28,00 USD | AH17-04271 | Sf 86 | 48,00 USD |
| AH08-01253 | Sf 21 | 142,00 USD | AH17-00371 | Sf 86 | 28,00 USD | AH17-04370 | Sf 86 | 118,00 USD |
| AH08-01263 | Sf 21 | 142,00 USD | AH17-00470 | Sf 86 | 33,00 USD | AH17-04371 | Sf 86 | 118,00 USD |
| AH08-01293 | Sf 21 | 144,00 USD | AH17-00471 | Sf 86 | 33,00 USD | AH17-04470 | Sf 86 | 93,00 USD |
| AH08-03600 | Sf 21 | 67,20 USD | AH17-00670 | Sf 86 | 33,00 USD | AH17-04471 | Sf 86 | 93,00 USD |
| AH08-03630 | Sf 21 | 67,20 USD | AH17-00671 | Sf 86 | 33,00 USD | AH17-04570 | Sf 88 | 40,00 USD |
| AH08-03660 | Sf 21 | 67,20 USD | AH17-00770 | Sf 87 | 40,00 USD | AH17-04571 | Sf 88 | 40,00 USD |
| AH10-00104 | Sf 64 | 30,00 USD | AH17-00771 | Sf 87 | 40,00 USD | AH17-04670 | Sf 88 | 184,00 USD |
| AH10-00105 | Sf 64 | 30,00 USD | AH17-00870 | Sf 86 | 33,00 USD | AH17-04671 | Sf 88 | 184,00 USD |
| AH10-00107 | Sf 64 | 30,00 USD | AH17-00871 | Sf 86 | 33,00 USD | AH17-04770 | Sf 86 | 157,00 USD |
| AH10-00109 | Sf 64 | 30,00 USD | AH17-01070 | Sf 86 | 42,00 USD | AH17-04771 | Sf 86 | 157,00 USD |
| AH10-00134 | Sf 64 | 30,00 USD | AH17-01071 | Sf 86 | 42,00 USD | AH17-04870 | Sf 87 | 120,00 USD |
| AH10-00135 | Sf 64 | 30,00 USD | AH17-01270 | Sf 87 | 36,00 USD | AH17-04871 | Sf 87 | 120,00 USD |
| AH10-00137 | Sf 64 | 30,00 USD | AH17-01271 | Sf 87 | 36,00 USD | AH17-05170 | Sf 87 | 36,00 USD |
| AH10-00139 | Sf 64 | 30,00 USD | AH17-01370 | Sf 87 | 72,00 USD | AH17-05171 | Sf 87 | 36,00 USD |
| AH11-00200 | Sf 34 | 24,75 USD | AH17-01371 | Sf 87 | 72,00 USD | AH17-05370 | Sf 88 | 87,00 USD |
| AH11-00201 | Sf 34 | 24,75 USD | AH17-01470 | Sf 87 | 36,00 USD | AH17-05371 | Sf 88 | 87,00 USD |
| AH11-00204 | Sf 34 | 26,40 USD | AH17-01471 | Sf 87 | 36,00 USD | AH17-05570 | Sf 89 | 42,00 USD |
| AH11-00230 | Sf 34 | 24,75 USD | AH17-01570 | Sf 88 | 42,00 USD | AH17-05571 | Sf 89 | 42,00 USD |
| AH11-00231 | Sf 34 | 24,75 USD | AH17-01571 | Sf 88 | 42,00 USD | AH17-05870 | Sf 88 | 30,00 USD |
| AH11-00234 | Sf 34 | 26,40 USD | AH17-01870 | Sf 88 | 32,00 USD | AH17-05871 | Sf 88 | 30,00 USD |
| AH12-01333 | Sf 98 | 15,00 USD | AH17-01871 | Sf 88 | 32,00 USD | AH17-06070 | Sf 88 | 29,00 USD |
| AH12-01500 | Sf 71 | 11,50 USD | AH17-01970 | Sf 87 | 36,00 USD | AH17-06071 | Sf 88 | 29,00 USD |
| AH12-01501 | Sf 71 | 11,50 USD | AH17-01971 | Sf 87 | 36,00 USD | AH18-50100 | Sf 60 | 43,00 USD |
| AH12-01510 | Sf 71 | 11,50 USD | AH17-02070 | Sf 88 | 42,00 USD | AH18-50101 | Sf 60 | 43,00 USD |
| AH12-01511 | Sf 71 | 11,50 USD | AH17-02071 | Sf 88 | 42,00 USD | AH18-50104 | Sf 60 | 43,00 USD |
| AH12-01560 | Sf 71 | 11,50 USD | AH17-02270 | Sf 88 | 29,00 USD | AH18-50200 | Sf 60 | 38,00 USD |
| AH12-01561 | Sf 71 | 11,50 USD | AH17-02271 | Sf 88 | 29,00 USD | AH18-50201 | Sf 60 | 38,00 USD |
| AH12-01570 | Sf 71 | 11,50 USD | AH17-02470 | Sf 89 | 27,00 USD | AH18-50300 | Sf 60 | 51,00 USD |

İÇİNDEKİLER/INDEX

| Ürün Kodu | Sayfa | Fiyat | Ürün Kodu | Sayfa | Fiyat | Ürün Kodu | Sayfa | Fiyat |
|------------|-------|-----------|------------|-------|-------------|------------|-------|-------------|
| AH18-50301 | Sf 60 | 51,00 USD | AL01-11231 | Sf 37 | 85,00 USD | AL02-07801 | Sf 92 | 183,00 USD |
| AH19-00170 | Sf 89 | 38,00 USD | AL01-12201 | Sf 36 | 88,00 USD | AL02-08101 | Sf 92 | 375,00 USD |
| AH19-00171 | Sf 89 | 38,00 USD | AL01-12211 | Sf 36 | 88,00 USD | AL02-08301 | Sf 92 | 77,00 USD |
| AH19-00270 | Sf 89 | 36,00 USD | AL01-12231 | Sf 36 | 88,00 USD | AL02-08401 | Sf 92 | 105,00 USD |
| AH19-00271 | Sf 89 | 36,00 USD | AL01-12601 | Sf 36 | 54,00 USD | AL02-08601 | Sf 92 | 158,00 USD |
| AH19-00370 | Sf 89 | 59,00 USD | AL01-12611 | Sf 36 | 54,00 USD | AL02-08801 | Sf 92 | 272,00 USD |
| AH19-00371 | Sf 89 | 59,00 USD | AL01-12631 | Sf 36 | 54,00 USD | AL02-10001 | Sf 93 | 133,00 USD |
| AH19-00470 | Sf 89 | 55,00 USD | AL01-12901 | Sf 36 | 70,00 USD | AL02-10201 | Sf 93 | 160,00 USD |
| AH19-00471 | Sf 89 | 55,00 USD | AL01-12911 | Sf 36 | 70,00 USD | AL02-10501 | Sf 93 | 200,00 USD |
| AH19-00570 | Sf 89 | 26,00 USD | AL01-12931 | Sf 36 | 70,00 USD | AL02-10503 | Sf 93 | 266,00 USD |
| AH19-00571 | Sf 89 | 26,00 USD | AL01-20601 | Sf 37 | 32,00 USD | AL02-11101 | Sf 93 | 153,00 USD |
| AH19-00770 | Sf 89 | 45,00 USD | AL01-20611 | Sf 37 | 32,00 USD | AL02-11201 | Sf 93 | 178,00 USD |
| AH19-00771 | Sf 89 | 45,00 USD | AL01-20631 | Sf 37 | 32,00 USD | AL02-11501 | Sf 93 | 228,00 USD |
| AH19-01170 | Sf 89 | 39,00 USD | AL01-20901 | Sf 37 | 44,00 USD | AL02-12101 | Sf 93 | 222,00 USD |
| AH19-01171 | Sf 89 | 39,00 USD | AL01-20911 | Sf 37 | 44,00 USD | AL02-12201 | Sf 93 | 266,00 USD |
| AH19-01270 | Sf 90 | 39,00 USD | AL01-20931 | Sf 37 | 44,00 USD | AL02-12501 | Sf 93 | 333,00 USD |
| AH19-01271 | Sf 90 | 39,00 USD | AL01-21201 | Sf 37 | 54,00 USD | AL02-13101 | Sf 92 | 125,00 USD |
| AH19-01370 | Sf 90 | 42,00 USD | AL01-21211 | Sf 37 | 54,00 USD | AL02-13201 | Sf 92 | 150,00 USD |
| AH19-01371 | Sf 90 | 42,00 USD | AL01-21231 | Sf 37 | 54,00 USD | AL02-13501 | Sf 92 | 250,00 USD |
| AH19-01470 | Sf 90 | 40,00 USD | AL01-22201 | Sf 36 | 62,00 USD | AL02-14101 | Sf 92 | 105,00 USD |
| AH19-01471 | Sf 90 | 40,00 USD | AL01-22211 | Sf 36 | 62,00 USD | AL02-14201 | Sf 92 | 125,00 USD |
| AH19-01570 | Sf 90 | 31,00 USD | AL01-22231 | Sf 36 | 62,00 USD | AL02-14501 | Sf 92 | 158,00 USD |
| AH19-01571 | Sf 90 | 31,00 USD | AL01-22601 | Sf 36 | 40,00 USD | AL02-15101 | Sf 92 | 230,00 USD |
| AH19-01670 | Sf 90 | 33,00 USD | AL01-22611 | Sf 36 | 40,00 USD | AL02-15201 | Sf 92 | 275,00 USD |
| AH19-01671 | Sf 90 | 33,00 USD | AL01-22631 | Sf 36 | 40,00 USD | AL02-15501 | Sf 92 | 344,00 USD |
| AH19-01770 | Sf 89 | 37,00 USD | AL01-22901 | Sf 36 | 52,00 USD | AL02-16101 | Sf 91 | 253,00 USD |
| AH19-01771 | Sf 89 | 37,00 USD | AL01-22911 | Sf 36 | 52,00 USD | AL02-16401 | Sf 91 | 97,00 USD |
| AH19-01870 | Sf 89 | 56,00 USD | AL01-22931 | Sf 36 | 52,00 USD | AL02-16601 | Sf 91 | 152,00 USD |
| AH19-01871 | Sf 89 | 56,00 USD | AL02-00101 | Sf 93 | 638,00 USD | AL02-16801 | Sf 91 | 202,00 USD |
| AH19-01970 | Sf 90 | 73,00 USD | AL02-00601 | Sf 90 | 63,00 USD | AL02-17101 | Sf 91 | 288,00 USD |
| AH19-01971 | Sf 90 | 73,00 USD | AL02-00601 | Sf 92 | 75,00 USD | AL02-17401 | Sf 91 | 116,00 USD |
| AH19-02070 | Sf 90 | 42,00 USD | AL02-00601 | Sf 93 | 380,00 USD | AL02-17601 | Sf 91 | 177,00 USD |
| AH19-02071 | Sf 90 | 42,00 USD | AL02-00801 | Sf 92 | 110,00 USD | AL02-17801 | Sf 91 | 236,00 USD |
| AL01-00601 | Sf 37 | 36,00 USD | AL02-00801 | Sf 93 | 511,00 USD | AL02-18301 | Sf 92 | 97,00 USD |
| AL01-00611 | Sf 37 | 36,00 USD | AL02-01101 | Sf 92 | 520,00 USD | AL02-18401 | Sf 92 | 130,00 USD |
| AL01-00631 | Sf 37 | 36,00 USD | AL02-01101 | Sf 93 | 1195,00 USD | AL02-18601 | Sf 92 | 194,00 USD |
| AL01-00901 | Sf 37 | 52,00 USD | AL02-01601 | Sf 92 | 310,00 USD | AL02-19101 | Sf 91 | 444,00 USD |
| AL01-00911 | Sf 37 | 52,00 USD | AL02-01801 | Sf 92 | 414,00 USD | AL02-19201 | Sf 91 | 533,00 USD |
| AL01-00931 | Sf 37 | 52,00 USD | AL02-02701 | Sf 93 | 920,00 USD | AL02-19501 | Sf 91 | 666,00 USD |
| AL01-01201 | Sf 37 | 60,00 USD | AL02-02801 | Sf 93 | 1084,00 USD | AL02-21201 | Sf 93 | 933,00 USD |
| AL01-01211 | Sf 37 | 60,00 USD | AL02-03101 | Sf 91 | 311,00 USD | AL02-21601 | Sf 93 | 555,00 USD |
| AL01-01231 | Sf 37 | 60,00 USD | AL02-03401 | Sf 91 | 122,00 USD | AL02-21801 | Sf 93 | 683,00 USD |
| AL01-02201 | Sf 36 | 72,00 USD | AL02-03601 | Sf 91 | 188,00 USD | AL02-22101 | Sf 92 | 283,00 USD |
| AL01-02211 | Sf 36 | 72,00 USD | AL02-03801 | Sf 91 | 250,00 USD | AL02-22401 | Sf 92 | 110,00 USD |
| AL01-02231 | Sf 36 | 72,00 USD | AL02-04101 | Sf 91 | 297,00 USD | AL02-22601 | Sf 92 | 166,00 USD |
| AL01-02601 | Sf 36 | 46,00 USD | AL02-04401 | Sf 91 | 70,00 USD | AL02-23401 | Sf 92 | 53,00 USD |
| AL01-02611 | Sf 36 | 46,00 USD | AL02-04601 | Sf 91 | 177,00 USD | AL02-23601 | Sf 92 | 84,00 USD |
| AL01-02631 | Sf 36 | 46,00 USD | AL02-04801 | Sf 91 | 231,00 USD | AL02-24401 | Sf 92 | 125,00 USD |
| AL01-02901 | Sf 36 | 63,00 USD | AL02-05101 | Sf 91 | 333,00 USD | AL02-24601 | Sf 92 | 188,00 USD |
| AL01-02911 | Sf 36 | 63,00 USD | AL02-05401 | Sf 91 | 134,00 USD | AL02-25101 | Sf 93 | 1250,00 USD |
| AL01-02931 | Sf 36 | 63,00 USD | AL02-05601 | Sf 91 | 203,00 USD | AL02-25601 | Sf 93 | 744,00 USD |
| AL01-10601 | Sf 37 | 46,00 USD | AL02-05801 | Sf 91 | 267,00 USD | AL02-25801 | Sf 93 | 994,00 USD |
| AL01-10611 | Sf 37 | 46,00 USD | AL02-06101 | Sf 92 | 378,00 USD | AL02-26601 | Sf 93 | 519,00 USD |
| AL01-10631 | Sf 37 | 46,00 USD | AL02-06401 | Sf 92 | 142,00 USD | AL02-26701 | Sf 93 | 566,00 USD |
| AL01-10901 | Sf 37 | 66,00 USD | AL02-06601 | Sf 92 | 214,00 USD | AL02-26801 | Sf 93 | 877,00 USD |
| AL01-10911 | Sf 37 | 66,00 USD | AL02-06801 | Sf 92 | 284,00 USD | AL02-27401 | Sf 93 | 444,00 USD |
| AL01-10931 | Sf 37 | 66,00 USD | AL02-07101 | Sf 92 | 227,00 USD | AL02-27501 | Sf 93 | 458,00 USD |
| AL01-11201 | Sf 37 | 85,00 USD | AL02-07401 | Sf 92 | 88,00 USD | AL02-27801 | Sf 93 | 755,00 USD |
| AL01-11211 | Sf 37 | 85,00 USD | AL02-07601 | Sf 92 | 138,00 USD | AL02-29301 | Sf 93 | 338,00 USD |

İÇİNDEKİLER/INDEX

| Ürün Kodu | Sayfa | Fiyat | Ürün Kodu | Sayfa | Fiyat | Ürün Kodu | Sayfa | Fiyat |
|------------|-------|------------|------------|-------|-----------|------------|-------|---------------|
| AL02-29401 | Sf 93 | 505,00 USD | AP01-01201 | Sf 15 | 11,50 USD | AP04-02430 | Sf 16 | 23,70 USD |
| AL02-29501 | Sf 93 | 505,00 USD | AP01-01210 | Sf 14 | 9,40 USD | AP04-02431 | Sf 16 | 26,20 USD |
| AL02-31601 | Sf 93 | 333,00 USD | AP01-01211 | Sf 15 | 11,50 USD | AP04-03300 | Sf 16 | 50,00 USD |
| AL02-31701 | Sf 93 | 505,00 USD | AP01-01230 | Sf 14 | 9,40 USD | AP04-03301 | Sf 16 | 53,00 USD |
| AL02-31801 | Sf 93 | 505,00 USD | AP01-01231 | Sf 15 | 11,50 USD | AP04-03310 | Sf 16 | 50,00 USD |
| AL02-32601 | Sf 93 | 666,00 USD | AP01-01500 | Sf 14 | 10,60 USD | AP04-03311 | Sf 16 | 53,00 USD |
| AL02-32701 | Sf 93 | 802,00 USD | AP01-01501 | Sf 15 | 12,50 USD | AP04-03330 | Sf 16 | 50,00 USD |
| AL02-32801 | Sf 93 | 802,00 USD | AP01-01510 | Sf 14 | 10,60 USD | AP04-03331 | Sf 16 | 53,00 USD |
| AL02-36101 | Sf 91 | 88,00 USD | AP01-01511 | Sf 15 | 12,50 USD | AP16-23300 | Sf 11 | 24,00 USD |
| AL02-37101 | Sf 90 | 88,00 USD | AP01-01530 | Sf 14 | 10,60 USD | AP16-23310 | Sf 11 | 24,00 USD |
| AL02-38101 | Sf 90 | 83,00 USD | AP01-01531 | Sf 15 | 12,50 USD | AP16-23330 | Sf 11 | 24,00 USD |
| AL02-39101 | Sf 90 | 92,00 USD | AP01-01534 | Sf 14 | 15,00 USD | AP16-33600 | Sf 11 | 45,00 USD |
| AL02-40101 | Sf 90 | 63,00 USD | AP01-01800 | Sf 14 | 11,50 USD | AP16-33610 | Sf 11 | 45,00 USD |
| AL02-41101 | Sf 90 | 95,00 USD | AP01-01801 | Sf 15 | 14,10 USD | AP16-33630 | Sf 11 | 45,00 USD |
| AL02-43101 | Sf 91 | 88,00 USD | AP01-01810 | Sf 14 | 11,50 USD | AP16-43100 | Sf 11 | 75,00 USD |
| AL02-44101 | Sf 90 | 67,00 USD | AP01-01811 | Sf 15 | 14,10 USD | AP16-43110 | Sf 11 | 75,00 USD |
| AL02-45101 | Sf 91 | 63,00 USD | AP01-01830 | Sf 14 | 11,50 USD | AP16-43130 | Sf 11 | 75,00 USD |
| AL02-47101 | Sf 90 | 88,00 USD | AP01-01831 | Sf 15 | 14,10 USD | AP16-46600 | Sf 11 | 52,00 USD |
| AL02-48101 | Sf 91 | 83,00 USD | AP01-01834 | Sf 14 | 17,50 USD | AP16-46610 | Sf 11 | 52,00 USD |
| AL02-49101 | Sf 91 | 67,00 USD | AP01-02000 | Sf 14 | 18,70 USD | AP16-46630 | Sf 11 | 52,00 USD |
| AL02-51101 | Sf 91 | 88,00 USD | AP01-02001 | Sf 15 | 21,60 USD | AP16-56600 | Sf 11 | 63,00 USD |
| AL02-52101 | Sf 91 | 63,00 USD | AP01-02010 | Sf 14 | 18,70 USD | AP16-56610 | Sf 11 | 63,00 USD |
| AL02-53101 | Sf 91 | 67,00 USD | AP01-02011 | Sf 15 | 21,60 USD | AP16-56630 | Sf 11 | 63,00 USD |
| AN10-00400 | Sf 40 | 8,50 USD | AP01-02030 | Sf 14 | 18,70 USD | AP17-33300 | Sf 11 | 24,70 USD |
| AN10-00430 | Sf 40 | 8,50 USD | AP01-02031 | Sf 15 | 21,60 USD | AP17-33310 | Sf 11 | 24,70 USD |
| AN10-00700 | Sf 40 | 10,80 USD | AP03-01200 | Sf 17 | 11,90 USD | AP17-33330 | Sf 11 | 24,70 USD |
| AN10-00730 | Sf 40 | 10,80 USD | AP03-01201 | Sf 17 | 13,10 USD | AP17-46600 | Sf 11 | 54,00 USD |
| AN10-01100 | Sf 40 | 13,50 USD | AP03-01210 | Sf 17 | 11,90 USD | AP17-46610 | Sf 11 | 54,00 USD |
| AN10-01130 | Sf 40 | 13,50 USD | AP03-01211 | Sf 17 | 13,10 USD | AP17-46630 | Sf 11 | 54,00 USD |
| AN10-01400 | Sf 40 | 15,50 USD | AP03-01230 | Sf 17 | 11,90 USD | AP20-23300 | Sf 12 | Fiyat Sorunuz |
| AN10-01430 | Sf 40 | 15,50 USD | AP03-01231 | Sf 17 | 13,10 USD | AP20-23300 | Sf 12 | 23,80 USD |
| AN10-21430 | Sf 40 | 23,40 USD | AP03-01800 | Sf 17 | 15,00 USD | AP20-23310 | Sf 12 | Fiyat Sorunuz |
| AN18-00603 | Sf 40 | 11,00 USD | AP03-01801 | Sf 17 | 16,20 USD | AP20-23310 | Sf 12 | 23,80 USD |
| AN18-00633 | Sf 40 | 11,00 USD | AP03-01810 | Sf 17 | 15,00 USD | AP20-23330 | Sf 12 | Fiyat Sorunuz |
| AN18-01203 | Sf 40 | 16,50 USD | AP03-01811 | Sf 17 | 16,20 USD | AP20-23330 | Sf 12 | 23,80 USD |
| AN18-01233 | Sf 40 | 16,50 USD | AP03-01830 | Sf 17 | 15,00 USD | AP20-26600 | Sf 13 | 39,00 USD |
| AN20-00603 | Sf 41 | 25,80 USD | AP03-01831 | Sf 17 | 16,20 USD | AP20-26610 | Sf 13 | 39,00 USD |
| AN20-00633 | Sf 41 | 25,80 USD | AP03-02400 | Sf 17 | 21,90 USD | AP20-26630 | Sf 13 | 39,00 USD |
| AN20-01203 | Sf 41 | 37,20 USD | AP03-02401 | Sf 17 | 24,40 USD | AP20-46600 | Sf 13 | Fiyat Sorunuz |
| AN20-01233 | Sf 41 | 37,20 USD | AP03-02410 | Sf 17 | 21,90 USD | AP20-46600 | Sf 13 | 39,00 USD |
| AP01-00300 | Sf 14 | 4,37 USD | AP03-02411 | Sf 17 | 24,40 USD | AP20-46610 | Sf 13 | Fiyat Sorunuz |
| AP01-00301 | Sf 15 | 5,40 USD | AP03-02430 | Sf 17 | 21,90 USD | AP20-46610 | Sf 13 | 39,00 USD |
| AP01-00310 | Sf 14 | 4,37 USD | AP03-02431 | Sf 17 | 24,40 USD | AP20-46630 | Sf 13 | Fiyat Sorunuz |
| AP01-00311 | Sf 15 | 5,40 USD | AP04-01200 | Sf 16 | 13,10 USD | AP20-46630 | Sf 13 | 39,00 USD |
| AP01-00330 | Sf 14 | 4,37 USD | AP04-01201 | Sf 16 | 14,80 USD | AP20-56600 | Sf 13 | 40,00 USD |
| AP01-00331 | Sf 15 | 5,40 USD | AP04-01210 | Sf 16 | 13,10 USD | AP20-56610 | Sf 13 | 40,00 USD |
| AP01-00600 | Sf 14 | 6,10 USD | AP04-01211 | Sf 16 | 14,80 USD | AP20-56630 | Sf 13 | 40,00 USD |
| AP01-00601 | Sf 15 | 7,50 USD | AP04-01230 | Sf 16 | 13,10 USD | AP21-23300 | Sf 12 | 25,00 USD |
| AP01-00610 | Sf 14 | 6,10 USD | AP04-01231 | Sf 16 | 14,80 USD | AP21-23300 | Sf 12 | Fiyat Sorunuz |
| AP01-00611 | Sf 15 | 7,50 USD | AP04-01800 | Sf 16 | 16,90 USD | AP21-23310 | Sf 12 | 25,00 USD |
| AP01-00630 | Sf 14 | 6,10 USD | AP04-01801 | Sf 16 | 18,10 USD | AP21-23310 | Sf 12 | Fiyat Sorunuz |
| AP01-00631 | Sf 15 | 7,50 USD | AP04-01810 | Sf 16 | 16,90 USD | AP21-23330 | Sf 12 | 25,00 USD |
| AP01-00900 | Sf 14 | 8,10 USD | AP04-01811 | Sf 16 | 18,10 USD | AP21-23330 | Sf 12 | Fiyat Sorunuz |
| AP01-00901 | Sf 15 | 9,90 USD | AP04-01830 | Sf 16 | 16,90 USD | AP21-26600 | Sf 13 | 40,00 USD |
| AP01-00910 | Sf 14 | 8,10 USD | AP04-01831 | Sf 16 | 18,10 USD | AP21-26610 | Sf 13 | 40,00 USD |
| AP01-00911 | Sf 15 | 9,90 USD | AP04-02400 | Sf 16 | 23,70 USD | AP21-26630 | Sf 13 | 40,00 USD |
| AP01-00930 | Sf 14 | 8,10 USD | AP04-02401 | Sf 16 | 26,20 USD | AP21-46600 | Sf 13 | Fiyat Sorunuz |
| AP01-00931 | Sf 15 | 9,90 USD | AP04-02410 | Sf 16 | 23,70 USD | AP21-46600 | Sf 13 | 40,00 USD |
| AP01-01200 | Sf 14 | 9,40 USD | AP04-02411 | Sf 16 | 26,20 USD | AP21-46610 | Sf 13 | Fiyat Sorunuz |

İÇİNDEKİLER/INDEX

| Ürün Kodu | Sayfa | Fiyat | Ürün Kodu | Sayfa | Fiyat | Ürün Kodu | Sayfa | Fiyat |
|------------|--------|---------------|---------------|--------|------------|------------|-------|------------|
| AP21-46610 | Sf 13 | 40,00 USD | AS90-00106 | Sf 101 | 51,00 USD | AT11-01200 | Sf 67 | 13,20 USD |
| AP21-46630 | Sf 13 | Fiyat Sorunuz | AS90-00109 | Sf 101 | 56,00 USD | AT11-01230 | Sf 67 | 13,20 USD |
| AP21-46630 | Sf 13 | 40,00 USD | AS90-00200 | Sf 101 | 77,00 USD | AT11-11800 | Sf 66 | 19,20 USD |
| AP21-56600 | Sf 13 | 42,00 USD | AS90-00203 | Sf 101 | 77,00 USD | AT11-11830 | Sf 66 | 19,20 USD |
| AP21-56610 | Sf 13 | 42,00 USD | AS90-00300 | Sf 101 | 210,00 USD | AT11-31100 | Sf 67 | 19,20 USD |
| AP21-56630 | Sf 13 | 42,00 USD | AS90-00303 | Sf 101 | 210,00 USD | AT11-31130 | Sf 67 | 19,20 USD |
| AS01-00300 | Sf 84 | 2,10 USD | AS90-00306 | Sf 101 | 210,00 USD | AT20-00603 | Sf 25 | 33,00 USD |
| AS01-00301 | Sf 84 | 2,10 USD | AS90-00400 | Sf 101 | 13,30 USD | AT20-00633 | Sf 25 | 33,00 USD |
| AS01-00303 | Sf 84 | 2,10 USD | AS90-00403 | Sf 101 | 13,30 USD | AT20-00643 | Sf 25 | 33,00 USD |
| AS01-00304 | Sf 84 | 2,10 USD | AS90-00404 | Sf 101 | 13,30 USD | AT20-00653 | Sf 25 | 33,00 USD |
| AS01-00305 | Sf 84 | 2,10 USD | AS90-00405 | Sf 101 | 13,30 USD | AT20-00663 | Sf 25 | 33,00 USD |
| AS01-00306 | Sf 84 | 2,10 USD | AS90-00406 | Sf 101 | 13,30 USD | AT20-00673 | Sf 25 | 33,00 USD |
| AS01-00308 | Sf 84 | 2,10 USD | AS90-00500 | Sf 101 | 81,20 USD | AT20-00683 | Sf 25 | 33,00 USD |
| AS01-00309 | Sf 84 | 3,50 USD | AS90-00503 | Sf 101 | 81,20 USD | AT20-00693 | Sf 25 | 60,00 USD |
| AS01-00500 | Sf 84 | 4,50 USD | AS90-00504 | Sf 101 | 81,20 USD | AT20-00903 | Sf 25 | 40,70 USD |
| AS01-00503 | Sf 84 | 4,50 USD | AS90-00506 | Sf 101 | 81,20 USD | AT20-00933 | Sf 25 | 40,70 USD |
| AS01-00504 | Sf 84 | 4,50 USD | AS90-00603 | Sf 101 | 102,00 USD | AT20-00943 | Sf 25 | 40,70 USD |
| AS01-00505 | Sf 84 | 4,50 USD | AS90-00606 | Sf 101 | 102,00 USD | AT20-00953 | Sf 25 | 40,70 USD |
| AS01-00506 | Sf 84 | 4,50 USD | AS90-00709 | Sf 101 | 14,70 USD | AT20-00963 | Sf 25 | 40,70 USD |
| AS01-00508 | Sf 84 | 4,50 USD | AS90-00800 | Sf 101 | 31,00 USD | AT20-00973 | Sf 25 | 40,70 USD |
| AS03-00500 | Sf 84 | 7,00 USD | AS90-00803 | Sf 101 | 31,00 USD | AT20-00983 | Sf 25 | 40,70 USD |
| AS03-00503 | Sf 84 | 7,00 USD | AS90-00950 | Sf 101 | 6,65 USD | AT20-00993 | Sf 25 | 72,00 USD |
| AS03-00504 | Sf 84 | 7,00 USD | AS90-00953 | Sf 101 | 6,65 USD | AT20-01203 | Sf 25 | 49,50 USD |
| AS03-00505 | Sf 84 | 7,00 USD | AS90-00990 | Sf 101 | 8,80 USD | AT20-01233 | Sf 25 | 49,50 USD |
| AS03-00506 | Sf 84 | 7,00 USD | AS90-00993 | Sf 101 | 8,80 USD | AT20-01243 | Sf 25 | 49,50 USD |
| AS03-00508 | Sf 84 | 7,00 USD | AS90-01000 | Sf 101 | 51,00 USD | AT20-01253 | Sf 25 | 49,50 USD |
| AS03-00509 | Sf 84 | 15,60 USD | AS90-01003 | Sf 101 | 51,00 USD | AT20-01263 | Sf 25 | 49,50 USD |
| AS04-00100 | Sf 84 | 1,00 USD | AT03-00600 | Sf 39 | 22,00 USD | AT20-01273 | Sf 25 | 49,50 USD |
| AS04-00103 | Sf 84 | 1,00 USD | AT03-00610 | Sf 39 | 22,00 USD | AT20-01283 | Sf 25 | 49,50 USD |
| AS04-00200 | Sf 84 | 1,00 USD | AT03-00630 | Sf 39 | 22,00 USD | AT20-01293 | Sf 25 | 77,00 USD |
| AS04-00203 | Sf 84 | 1,00 USD | AT03-01200 | Sf 39 | 35,00 USD | AT20-01803 | Sf 25 | 67,70 USD |
| AS04-00204 | Sf 84 | 1,00 USD | AT03-01210 | Sf 39 | 35,00 USD | AT20-01833 | Sf 25 | 67,70 USD |
| AS04-00205 | Sf 84 | 1,00 USD | AT03-01230 | Sf 39 | 35,00 USD | AT20-01843 | Sf 25 | 67,70 USD |
| AS04-00206 | Sf 84 | 1,00 USD | AT03-106..... | Sf 39 | 37,00 USD | AT20-01853 | Sf 25 | 67,70 USD |
| AS04-00300 | Sf 84 | 1,90 USD | AT03-10600 | Sf 39 | 25,40 USD | AT20-01863 | Sf 25 | 67,70 USD |
| AS04-00303 | Sf 84 | 1,90 USD | AT03-10610 | Sf 39 | 25,40 USD | AT20-01873 | Sf 25 | 67,70 USD |
| AS05-00100 | Sf 82 | 4,40 USD | AT03-10630 | Sf 39 | 25,40 USD | AT20-01883 | Sf 25 | 67,70 USD |
| AS05-00101 | Sf 82 | 4,40 USD | AT03-112..... | Sf 39 | 50,00 USD | AT20-01893 | Sf 25 | 100,00 USD |
| AS05-00103 | Sf 82 | 4,40 USD | AT03-11200 | Sf 39 | 43,00 USD | AT20-03603 | Sf 25 | 99,00 USD |
| AS05-00106 | Sf 82 | 5,00 USD | AT03-11210 | Sf 39 | 43,00 USD | AT20-03633 | Sf 25 | 99,00 USD |
| AS10-01203 | Sf 82 | 11,00 USD | AT03-11230 | Sf 39 | 43,00 USD | AT20-03643 | Sf 25 | 99,00 USD |
| AS10-01213 | Sf 82 | 11,00 USD | AT03-206..... | Sf 39 | 41,00 USD | AT20-03653 | Sf 25 | 99,00 USD |
| AS10-01233 | Sf 82 | 11,00 USD | AT03-212..... | Sf 39 | 57,00 USD | AT20-03663 | Sf 25 | 99,00 USD |
| AS10-02403 | Sf 82 | 11,50 USD | AT10-00800 | Sf 67 | 9,50 USD | AT20-03673 | Sf 25 | 99,00 USD |
| AS10-02413 | Sf 82 | 11,50 USD | AT10-00830 | Sf 67 | 9,50 USD | AT20-03683 | Sf 25 | 99,00 USD |
| AS10-02433 | Sf 82 | 11,50 USD | AT10-01200 | Sf 67 | 13,20 USD | AT20-03693 | Sf 25 | 143,00 USD |
| AS10-11203 | Sf 82 | 10,00 USD | AT10-01230 | Sf 67 | 13,20 USD | AT21-01800 | Sf 29 | 140,00 USD |
| AS10-11213 | Sf 82 | 10,00 USD | AT10-01800 | Sf 67 | 22,20 USD | AT21-03600 | Sf 29 | 240,00 USD |
| AS10-11233 | Sf 82 | 10,00 USD | AT10-01830 | Sf 67 | 22,20 USD | AT25-00301 | Sf 47 | 28,00 USD |
| AS11-01203 | Sf 82 | 12,00 USD | AT10-11500 | Sf 67 | 25,80 USD | AT25-00331 | Sf 47 | 28,00 USD |
| AS11-01213 | Sf 82 | 12,00 USD | AT10-11530 | Sf 67 | 25,80 USD | AT25-00351 | Sf 47 | 28,00 USD |
| AS11-01233 | Sf 82 | 12,00 USD | AT10-21500 | Sf 67 | 25,80 USD | AT25-00381 | Sf 47 | 28,00 USD |
| AS11-02403 | Sf 82 | 12,65 USD | AT10-21530 | Sf 67 | 25,80 USD | AT38-06000 | Sf 38 | 220,00 USD |
| AS11-02413 | Sf 82 | 12,65 USD | AT10-21801 | Sf 66 | 28,80 USD | AT38-06010 | Sf 38 | 220,00 USD |
| AS11-02433 | Sf 82 | 12,65 USD | AT10-31831 | Sf 66 | 28,80 USD | AT38-06030 | Sf 38 | 220,00 USD |
| AS90-00100 | Sf 101 | 51,00 USD | AT10-41801 | Sf 66 | 28,80 USD | AT38-07500 | Sf 38 | 242,00 USD |
| AS90-00103 | Sf 101 | 51,00 USD | AT10-51831 | Sf 66 | 28,80 USD | AT38-07510 | Sf 38 | 242,00 USD |
| AS90-00104 | Sf 101 | 51,00 USD | AT11-00800 | Sf 67 | 9,50 USD | AT38-07530 | Sf 38 | 242,00 USD |
| AS90-00105 | Sf 101 | 51,00 USD | AT11-00830 | Sf 67 | 9,50 USD | AT38-09000 | Sf 38 | 248,00 USD |

İÇİNDEKİLER/INDEX

| Ürün Kodu | Sayfa | Fiyat | Ürün Kodu | Sayfa | Fiyat | Ürün Kodu | Sayfa | Fiyat |
|------------|-------|------------|------------|-------|------------|------------|-------|-----------|
| AT38-09010 | Sf 38 | 248,00 USD | AT61-09402 | Sf 28 | 155,00 USD | AY40-00201 | Sf 61 | 2,20 USD |
| AT38-09030 | Sf 38 | 248,00 USD | AT61-09432 | Sf 28 | 155,00 USD | AY40-00203 | Sf 61 | 2,20 USD |
| AT41-05000 | Sf 23 | 57,50 USD | AT61-09602 | Sf 28 | 210,00 USD | AY40-00210 | Sf 61 | 3,25 USD |
| AT41-05010 | Sf 23 | 57,50 USD | AT61-09632 | Sf 28 | 210,00 USD | AY40-00211 | Sf 61 | 3,25 USD |
| AT41-05030 | Sf 23 | 57,50 USD | AT61-09802 | Sf 28 | 390,00 USD | AY40-00213 | Sf 61 | 3,25 USD |
| AT41-08000 | Sf 23 | 95,00 USD | AT61-09832 | Sf 28 | 390,00 USD | AY40-00220 | Sf 61 | 0,60 USD |
| AT41-08010 | Sf 23 | 95,00 USD | AT61-19102 | Sf 27 | 70,00 USD | AY40-00221 | Sf 61 | 0,60 USD |
| AT41-08030 | Sf 23 | 95,00 USD | AT61-19132 | Sf 27 | 70,00 USD | AY40-00223 | Sf 61 | 0,60 USD |
| AT41-09100 | Sf 23 | 132,00 USD | AT61-19402 | Sf 27 | 130,00 USD | AY40-00230 | Sf 61 | 3,50 USD |
| AT41-09110 | Sf 23 | 132,00 USD | AT61-19432 | Sf 27 | 130,00 USD | AY40-00231 | Sf 61 | 3,50 USD |
| AT41-09130 | Sf 23 | 132,00 USD | AT61-19602 | Sf 27 | 160,00 USD | AY40-00233 | Sf 61 | 3,50 USD |
| AT42-06031 | Sf 22 | 89,00 USD | AT61-19632 | Sf 27 | 160,00 USD | AY40-00240 | Sf 61 | 2,50 USD |
| AT42-09031 | Sf 22 | 102,00 USD | AT61-22032 | Sf 28 | 42,00 USD | AY40-00241 | Sf 61 | 2,50 USD |
| AT42-09131 | Sf 22 | 144,00 USD | AT61-23032 | Sf 28 | 50,00 USD | AY40-00243 | Sf 61 | 2,50 USD |
| AT44-09130 | Sf 33 | 163,00 USD | AT61-25032 | Sf 28 | 62,00 USD | AY40-00250 | Sf 61 | 4,00 USD |
| AT45-06003 | Sf 31 | 150,00 USD | AT61-45032 | Sf 27 | 75,60 USD | AY40-00251 | Sf 61 | 4,00 USD |
| AT45-06013 | Sf 31 | 150,00 USD | AY02-00250 | Sf 83 | 7,00 USD | AY40-00253 | Sf 61 | 4,00 USD |
| AT45-06033 | Sf 31 | 150,00 USD | AY02-00600 | Sf 83 | 11,10 USD | AY40-00260 | Sf 61 | 5,70 USD |
| AT45-07503 | Sf 31 | 181,00 USD | AY02-01000 | Sf 83 | 15,20 USD | AY40-00261 | Sf 61 | 5,70 USD |
| AT45-07513 | Sf 31 | 181,00 USD | AY02-01500 | Sf 83 | 20,30 USD | AY40-00263 | Sf 61 | 5,70 USD |
| AT45-07533 | Sf 31 | 181,00 USD | AY02-02000 | Sf 83 | 24,10 USD | AY40-02020 | Sf 62 | 44,00 USD |
| AT45-19103 | Sf 31 | 231,00 USD | AY02-02500 | Sf 83 | 27,50 USD | AY40-02021 | Sf 62 | 44,00 USD |
| AT45-19113 | Sf 31 | 231,00 USD | AY02-03600 | Sf 83 | 31,70 USD | AY40-02023 | Sf 62 | 44,00 USD |
| AT45-19133 | Sf 31 | 231,00 USD | AY02-05000 | Sf 83 | 51,00 USD | AY40-02030 | Sf 62 | 66,00 USD |
| AT45-29203 | Sf 31 | 262,00 USD | AY25-00110 | Sf 73 | 0,55 USD | AY40-02031 | Sf 62 | 66,00 USD |
| AT45-29213 | Sf 31 | 262,00 USD | AY26-00010 | Sf 73 | 16,50 USD | AY40-02033 | Sf 62 | 66,00 USD |
| AT45-29233 | Sf 31 | 262,00 USD | AY26-00020 | Sf 73 | 9,80 USD | AY40-02100 | Sf 62 | 20,00 USD |
| AT45-29403 | Sf 31 | 267,00 USD | AY26-01010 | Sf 72 | 20,40 USD | AY40-02101 | Sf 62 | 20,00 USD |
| AT45-29413 | Sf 31 | 267,00 USD | AY30-00110 | Sf 72 | 13,70 USD | AY40-02103 | Sf 62 | 20,00 USD |
| AT45-29433 | Sf 31 | 26700 USD | AY30-00120 | Sf 72 | 16,80 USD | AY40-02110 | Sf 62 | 7,00 USD |
| AT46-05003 | Sf 32 | 80,00 USD | AY30-00140 | Sf 72 | 18,00 USD | AY40-02111 | Sf 62 | 7,00 USD |
| AT46-05013 | Sf 32 | 80,00 USD | AY30-00160 | Sf 72 | 28,80 USD | AY40-02113 | Sf 62 | 7,00 USD |
| AT46-05033 | Sf 32 | 80,00 USD | AY30-00170 | Sf 72 | 30,00 USD | AY40-02120 | Sf 62 | 0,66 USD |
| AT46-19103 | Sf 32 | 141,00 USD | AY30-00180 | Sf 72 | 30,00 USD | AY40-02121 | Sf 62 | 0,66 USD |
| AT46-19113 | Sf 32 | 141,00 USD | AY30-00190 | Sf 72 | 6,00 USD | AY40-02123 | Sf 62 | 0,66 USD |
| AT46-19133 | Sf 32 | 141,00 USD | AY30-01010 | Sf 72 | 15,00 USD | AY40-02130 | Sf 62 | 9,00 USD |
| AT46-29403 | Sf 32 | 192,00 USD | AY30-01020 | Sf 84 | 6,70 USD | AY40-02131 | Sf 62 | 9,00 USD |
| AT46-29413 | Sf 32 | 192,00 USD | AY30-01030 | Sf 84 | 7,80 USD | AY40-02133 | Sf 62 | 9,00 USD |
| AT46-29433 | Sf 32 | 192,00 USD | AY30-01110 | Sf 72 | 21,60 USD | AY40-02140 | Sf 62 | 7,20 USD |
| AT46-49403 | Sf 32 | 244,00 USD | AY30-01120 | Sf 72 | 24,00 USD | AY40-02141 | Sf 62 | 7,20 USD |
| AT46-49413 | Sf 32 | 244,00 USD | AY30-01130 | Sf 72 | 4,20 USD | AY40-02143 | Sf 62 | 7,20 USD |
| AT46-49433 | Sf 32 | 244,00 USD | AY30-02006 | Sf 70 | 12,00 USD | AY40-02150 | Sf 62 | 15,60 USD |
| AT61-01002 | Sf 27 | 11,00 USD | AY30-02019 | Sf 70 | 12,00 USD | AY40-02151 | Sf 62 | 15,60 USD |
| AT61-01032 | Sf 27 | 11,00 USD | AY30-02021 | Sf 70 | 19,80 USD | AY40-02153 | Sf 62 | 15,60 USD |
| AT61-01052 | Sf 27 | 13,00 USD | AY31-01010 | Sf 34 | 11,55 USD | AY40-02160 | Sf 62 | 20,00 USD |
| AT61-02002 | Sf 27 | 18,00 USD | AY31-01030 | Sf 34 | 11,55 USD | AY40-02161 | Sf 62 | 20,00 USD |
| AT61-02032 | Sf 27 | 18,00 USD | AY31-01040 | Sf 34 | 10,50 USD | AY40-02163 | Sf 62 | 20,00 USD |
| AT61-02052 | Sf 27 | 20,00 USD | AY31-01050 | Sf 34 | 10,50 USD | AY45-00100 | Sf 81 | 5,90 USD |
| AT61-03002 | Sf 27 | 24,50 USD | AY31-02020 | Sf 34 | 14,10 USD | AY45-00101 | Sf 81 | 5,90 USD |
| AT61-03032 | Sf 27 | 24,50 USD | AY40-00110 | Sf 61 | 7,76 USD | AY45-00200 | Sf 81 | 6,50 USD |
| AT61-03052 | Sf 27 | 27,00 USD | AY40-00111 | Sf 61 | 7,76 USD | AY90-00100 | Sf 73 | 0,60 USD |
| AT61-05002 | Sf 27 | 35,00 USD | AY40-00113 | Sf 61 | 7,76 USD | AY90-00101 | Sf 73 | 0,60 USD |
| AT61-05032 | Sf 27 | 35,00 USD | AY40-00120 | Sf 61 | 15,50 USD | AY90-00102 | Sf 73 | 0,60 USD |
| AT61-05052 | Sf 27 | 37,00 USD | AY40-00121 | Sf 61 | 15,50 USD | AY90-00104 | Sf 73 | 0,60 USD |
| AT61-05082 | Sf 27 | 37,00 USD | AY40-00123 | Sf 61 | 15,50 USD | AY90-00105 | Sf 73 | 0,60 USD |
| AT61-07002 | Sf 28 | 65,00 USD | AY40-00130 | Sf 61 | 23,30 USD | AY90-00106 | Sf 73 | 0,60 USD |
| AT61-07032 | Sf 28 | 65,00 USD | AY40-00131 | Sf 61 | 23,30 USD | AY90-00107 | Sf 73 | 0,60 USD |
| AT61-09102 | Sf 28 | 85,00 USD | AY40-00133 | Sf 61 | 23,30 USD | H05-95-003 | Sf 84 | 1,32 USD |
| AT61-09132 | Sf 28 | 85,00 USD | AY40-00200 | Sf 61 | 2,20 USD | | | |

LED Slim Panel Armatürler

LED Silim Panel Luminaires

Sıva Altı LED Slim Panel Armatürler

Alüminyum çerçeve yapısı ile yüksek dayanım. İstenilen RAL kodunda çerçeve renk seçeneği. Yüksek kaliteli ve geçirgenlikte PMMA veya PS, LGP difüzör seçeneği. Yüksek sıklıktaki verimli led dizilimi ile kamaşma karanlık bölge ve hotspot yapmayan özellikler ile, çeşitli güçlerde ve renk seçenekleriyle geniş bir kullanım seçeneği sunmaktadır. Standart 30-60-120 cm üretim yapılabilir. DALI, triac dimming ve acil kit uygulaması opsiyoneldir



Teknik Özellikler

| | 300 X300 | 600X600 | 600X600 | 300 X600 | 300X1200 |
|------------------------|--------------|--------------|--------------|--------------|--------------|
| Güç Tüketimi | 12 W +/- 5% | 40 W +/- 5% | 48 W +/- 5% | 24 W +/- 5% | 40 W +/- 5% |
| Besleme Gerilimi | AC 220-240 V | AC 220-240 V | AC 220-240 V | AC 220-240 V | AC 220-240 V |
| Besleme Akımı | 52 mA | 173 mA | 208 mA | 104 mA | 173 mA |
| Frekans | 50-60 Hz | 50-60 Hz | 50-60 Hz | 50-60 Hz | 50-60 Hz |
| Güç Faktörü Düzeltmesi | 0,95 Pf | 0,95 Pf | 0,95 Pf | 0,95 Pf | 0,95 Pf |
| Driver Verimliliği | 89 % | 89 % | 89 % | 89 % | 89 % |
| Lümen/Watt | 85 lm/W | 85 lm/W | 85 lm/W | 85 lm/W | 85 lm/W |
| Led Adedi | 60 ad | 204 ad | 204 ad | 120 ad | 204 ad |
| Aydınlatma Açısı | 100° | 100° | 100° | 100° | 100° |
| Led Tipi | 4014 | 4014 | 4014 | 4014 | 4014 |
| CRI | Ra≥80 | Ra≥80 | Ra≥80 | Ra≥80 | Ra≥80 |
| Işık Akısı | 1,020 lm | 3,400 lm | 4,080 lm | 2,040 lm | 3,400 lm |
| Çalışma Isısı | -20/+45 °C | -20/+45 °C | -20/+45 °C | -20/+45 °C | -20/+45 °C |
| IP | IP 20 | IP 20 | IP 20 | IP 20 | IP 20 |
| Garanti | 2 Yıl | 2 Yıl | 2 Yıl | 2 Yıl | 2 Yıl |
| Led Ömrü | 30.000 Saat | 30.000 Saat | 30.000 Saat | 30.000 Saat | 30.000 Saat |

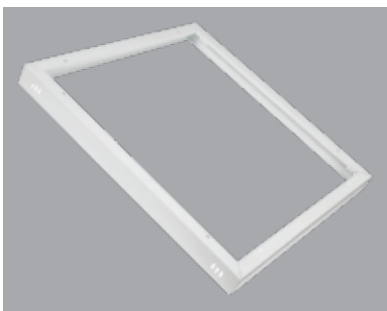
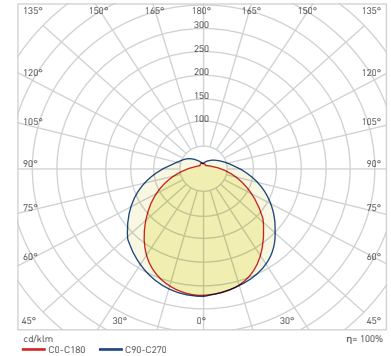

LED Slim Paneller İçin Sıva Üstü Kasası

| Kod | Ölçüsü | Fiyat |
|----------|----------------|----------|
| 6001-013 | 60 cm x 60 cm | 6,50 USD |
| 6001-016 | 30 cm x 30 cm | 5,75 USD |
| 6001-017 | 30 cm x 60 cm | 6,00 USD |
| 6001-018 | 30 cm x 120 cm | 8,50 USD |



4'lü Yay Seti

| Kod | Fiyat |
|----------|----------|
| 6095-012 | 3,60 USD |

LED Slim Panel Armatürler

LED Slim Panel Luminaires

12 W - 300X300 LED Slim Panel    



| Kod | Renk I. | I. Akısı | Fiyat |
|------------|---------|----------|-----------|
| AP16-23300 | 3000K | 900 lm | 24,00 USD |
| AP16-23310 | 4000K | 1020 lm | 24,00 USD |
| AP16-23330 | 6500K | 1020 lm | 24,00 USD |

Kesim Ölçüsü:
275 mm x 275 mm

Koli Mik.: 10 ad

12 W - 300X300 Clip-In LED S. Panel    



| Kod | Renk I. | I. Akısı | Fiyat |
|------------|---------|----------|-----------|
| AP17-33300 | 3000K | 900 lm | 24,70 USD |
| AP17-33310 | 4000K | 1020 lm | 24,70 USD |
| AP17-33330 | 6500K | 1020 lm | 24,70 USD |

Koli Mik.: 10 ad

40 W - 600X600 LED Slim Panel    



| Kod | Renk I. | I. Akısı | Fiyat |
|------------|---------|----------|-----------|
| AP16-46600 | 3000K | 3000 lm | 52,00 USD |
| AP16-46610 | 4000K | 3200 lm | 52,00 USD |
| AP16-46630 | 6500K | 3400 lm | 52,00 USD |

Kesim Ölçüsü:
575 mm x 575 mm

Koli Mik.: 5 ad

40 W - 600X600 Clip-In LED S. Panel    



| Kod | Renk I. | I. Akısı | Fiyat |
|------------|---------|----------|-----------|
| AP17-46600 | 3000K | 3000 lm | 54,00 USD |
| AP17-46610 | 4000K | 3400 lm | 54,00 USD |
| AP17-46630 | 6500K | 3400 lm | 54,00 USD |

Koli Mik.: 5 ad

48 W - 600X600 LED Slim Panel    



| Kod | Renk I. | I. Akısı | Fiyat |
|------------|---------|----------|-----------|
| AP16-56600 | 3000K | 3600 lm | 63,00 USD |
| AP16-56610 | 4000K | 3850 lm | 63,00 USD |
| AP16-56630 | 6500K | 4,080 lm | 63,00 USD |

Kesim Ölçüsü:
575 mm x 575 mm

Koli Mik.: 5 ad



24 W - 300X600 LED Slim Panel    



| Kod | Renk I. | I. Akısı | Fiyat |
|------------|---------|----------|-----------|
| AP16-33600 | 3000K | 1800 lm | 45,00 USD |
| AP16-33610 | 4000K | 2040 lm | 45,00 USD |
| AP16-33630 | 6500K | 2040 lm | 45,00 USD |

Kesim Ölçüsü: 275 mm x 575 mm

Koli Mik.: 10 ad

40 W - 300X1200 LED Slim Panel    



| Kod | Renk I. | I. Akısı | Fiyat |
|------------|---------|----------|-----------|
| AP16-43100 | 3000K | 3000 lm | 75,00 USD |
| AP16-43110 | 4000K | 3200 lm | 75,00 USD |
| AP16-43130 | 6500K | 3400 lm | 75,00 USD |

Kesim Ölçüsü: 275 mm x 1175 mm

Koli Mik.: 5 ad

LED Backlight Armatürler

LED Backlights

15 W - 300X300 S/A Backlight



| Kod | Renk I. | I. Akısı | Fiyat |
|------------|---------|----------|-----------|
| AP20-23300 | 3000K | 1450 lm | 23,80 USD |
| AP20-23310 | 4000K | 1450 lm | 23,80 USD |
| AP20-23330 | 6500K | 1450 lm | 23,80 USD |

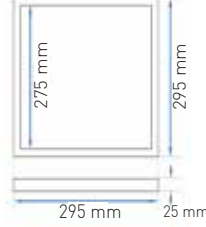

YÜKSEK LÜMENLİ

Kesim Ölçüsü:
275 mm x 275 mm

Koli Mik.: 10 ad

| Kod | Renk I. | I. Akısı | Fiyat |
|------------|---------|----------|-------|
| AP20-23300 | 3000K | 1650 lm | - |
| AP20-23310 | 4000K | 1700 lm | - |
| AP20-23330 | 6500K | 1750 lm | - |



Lümen/Watt:100 lm

Lütfen fiyat sorunuz

15 W - 300X300 S/A Clip-in Backlight

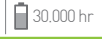

CLIP-IN



| Kod | Renk I. | I. Akısı | Fiyat |
|------------|---------|----------|-----------|
| AP21-23300 | 3000K | 1450 lm | 25,00 USD |
| AP21-23310 | 4000K | 1450 lm | 25,00 USD |
| AP21-23330 | 6500K | 1450 lm | 25,00 USD |

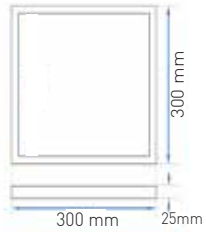

YÜKSEK LÜMENLİ

Koli Mik.:10 ad

| Kod | Renk I. | I. Akısı | Fiyat |
|------------|---------|----------|-------|
| AP21-23300 | 3000K | 1650 lm | - |
| AP21-23310 | 4000K | 1700 lm | - |
| AP21-23330 | 6500K | 1750 lm | - |



Lümen/Watt:100 lm

Lütfen fiyat sorunuz



DKP sac gövde üzerine elektrostatik toz boyalı yüksek dayanımlı gövde yapısı. Kamaşma yapmayan yüksek geçirgenlikli opal difüzör. Isıl iletimi yüksek alüminyum pcb yüksek lümenli, homojen ışık dağılımı, istenilen ışık rengi seçeneği. Opsiyonel olarak DALI ve acil kit uygulama seçeneği. Sıva üstü aparatıyla kolayca sıva üstü armatüre çevrilebilir yapıdadır.

Teknik Özellikler

| | 300 X 300 | 600 X 600 | 600 X 600 | 600 X 600 |
|--------------------|----------------|----------------|----------------|----------------|
| Güç Tüketimi | 15 W +/- 5% | 36 W +/- 5% | 42 W +/- 5% | 48 W +/- 5% |
| Besleme Gerilimi | AC 220-240 V | AC 220-240 V | AC 220-240 V | AC 220-240 V |
| Besleme Akımı | 0,065 A | 0,156 A | 0,182 A | 0,208 A |
| Frekans | 50-60 Hz | 50-60 Hz | 50-60 Hz | 50-60 Hz |
| Güç Faktörü Düz. | 0,95 Pf | 0,95 Pf | 0,95 Pf | 0,95 Pf |
| Driver Verimliliği | 87 % | 90 % | 90 % | 90 % |
| Lümen/Watt (4000K) | 85 lm/W | 85 lm/W | 85 lm/W | 85 lm/W |
| Aydınlatma Açısı | 100° | 100° | 100° | 100° |
| Led Tipi | 2835 | 2835 | 2835 | 2835 |
| Renk Isısı | 3000-4000-6500 | 3000-4000-6500 | 3000-4000-6500 | 3000-4000-6500 |
| CRI | Ra≥80 | Ra≥80 | Ra≥80 | Ra≥80 |
| Işık Akısı | 1,275 lm | 3,060 lm | 3,570 lm | 4,080 lm |
| Çalışma Isısı | -20/+45 °C | -20/+45 °C | -20/+45 °C | -20/+45 °C |
| IP | IP 20 | IP 20 | IP 20 | IP 20 |
| Garanti | 2 Yıl | 2 Yıl | 2 Yıl | 2 Yıl |
| Led Ömrü | 30.000 Saat | 30.000 Saat | 30.000 Saat | 30.000 Saat |

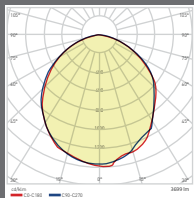

LED Backlight Armatürler

LED Backlights

36 W - 600X600 S/A Backlight

RoHS Compliant | CE | 30.000 hr | IP20

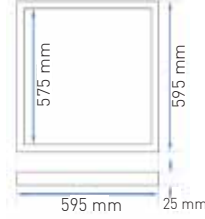

| Kod | Renk I. | I. Akısı | Fiyat |
|------------|---------|----------|-----------|
| AP20-26600 | 3000K | 3000 lm | 39,00 USD |
| AP20-26610 | 4000K | 3060 lm | 39,00 USD |
| AP20-26630 | 6500K | 3100 lm | 39,00 USD |

 Kesim Ölçüsü:
575 mm x 575 mm

Koli Mik.: 5 ad



36W - 600X600 S/A Clip-in Backlight

RoHS Compliant | CE | 30.000 hr | IP20

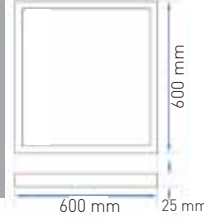

CLIP-IN

| Kod | Renk I. | I. Akısı | Fiyat |
|------------|---------|----------|-----------|
| AP21-26600 | 3000K | 3000 lm | 40,00 USD |
| AP21-26610 | 4000K | 3060 lm | 40,00 USD |
| AP21-26630 | 6500K | 3100 lm | 40,00 USD |



Koli Mik.: 5 ad

42 W - 600X600 S/A Backlight

RoHS Compliant | CE | 30.000 hr | IP20

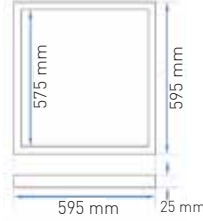

| Kod | Renk I. | I. Akısı | Fiyat |
|------------|---------|----------|-----------|
| AP20-46600 | 3000K | 3500 lm | 39,00 USD |
| AP20-46610 | 4000K | 3570 lm | 39,00 USD |
| AP20-46630 | 6500K | 3600 lm | 39,00 USD |

 Kesim Ölçüsü:
575 mm x 575 mm

Koli Mik.: 5 ad



| Kod | Renk I. | I. Akısı | Fiyat |
|------------|---------|----------|-------|
| AP20-46600 | 3000K | 4100 lm | - |
| AP20-46610 | 4000K | 4200 lm | - |
| AP20-46630 | 6500K | 4300 lm | - |



Lümen/Watt:100 lm

Lütfen fiyat sorunuz

42W - 600X600 S/A Clip-in Backlight

RoHS Compliant | CE | 30.000 hr | IP20



CLIP-IN

| Kod | Renk I. | I. Akısı | Fiyat |
|------------|---------|----------|-----------|
| AP21-46600 | 3000K | 3500 lm | 40,00 USD |
| AP21-46610 | 4000K | 3570 lm | 40,00 USD |
| AP21-46630 | 6500K | 3600 lm | 40,00 USD |

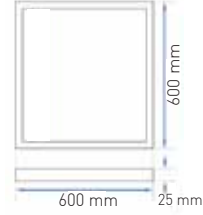

Koli Mik.: 5 ad



| Kod | Renk I. | I. Akısı | Fiyat |
|------------|---------|----------|-------|
| AP21-46600 | 3000K | 4100 lm | - |
| AP21-46610 | 4000K | 4200 lm | - |
| AP21-46630 | 6500K | 4300 lm | - |



Lümen/Watt:100 lm

Lütfen fiyat sorunuz

48 W - 600X600 S/A Backlight

RoHS Compliant | CE | 30.000 hr | IP20

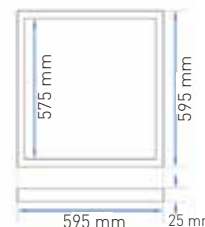

| Kod | Renk I. | I. Akısı | Fiyat |
|------------|---------|----------|-----------|
| AP20-56600 | 3000K | 3300 lm | 40,00 USD |
| AP20-56610 | 4000K | 3400 lm | 40,00 USD |
| AP20-56630 | 6500K | 3570 lm | 40,00 USD |

 Kesim Ölçüsü:
575 mm x 575 mm

Koli Mik.: 5 ad

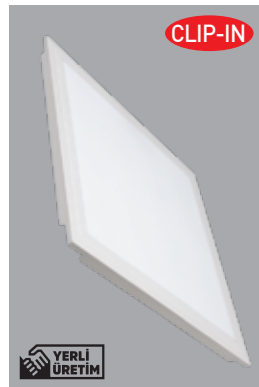

48 W - 600X600 S/A Clip-in Backlight

RoHS Compliant | CE | 30.000 hr | IP20

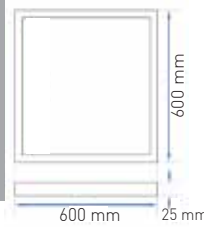

CLIP-IN

| Kod | Renk I. | I. Akısı | Fiyat |
|------------|---------|----------|-----------|
| AP21-56600 | 3000K | 3300 lm | 42,00 USD |
| AP21-56610 | 4000K | 3400 lm | 42,00 USD |
| AP21-56630 | 6500K | 3570 lm | 42,00 USD |



Koli Mik.: 5 ad



LED Panel Armatürler

LED Panel Luminaires

Sıva Altı Yuvarlak LED Panel Arm. (Beyaz Gövde)



ISO 9001

30.000 hr

IP20

115°

Çalışma Gerilimi : 220 V - 240 V
Aydınlatma Açısı : 115°



OSRAM LED Kullanılmıştır

| Kod | Güç | Kesim Ölçüsü | Işık Akısı | Renk Isısı | Gövde | Koli Mik. | Fiyat | |
|------------|------|--------------|------------|------------|-------|-----------|-----------|--|
| AP01-00300 | 3 W | 65 mm | 255 lm | 3000K | Beyaz | 40 ad. | 4,37 USD | |
| AP01-00310 | 3 W | 65 mm | 255 lm | 4000K | Beyaz | 40 ad. | 4,37 USD | |
| AP01-00330 | 3 W | 65 mm | 255 lm | 6500K | Beyaz | 40 ad. | 4,37 USD | |
| AP01-00600 | 6 W | 105 mm | 510 lm | 3000K | Beyaz | 40 ad. | 6,10 USD | |
| AP01-00610 | 6 W | 105 mm | 510 lm | 4000K | Beyaz | 40 ad. | 6,10 USD | |
| AP01-00630 | 6 W | 105 mm | 510 lm | 6500K | Beyaz | 40 ad. | 6,10 USD | |
| AP01-00900 | 9 W | 130 mm | 765 lm | 3000K | Beyaz | 40 ad. | 8,10 USD | |
| AP01-00910 | 9 W | 130 mm | 765 lm | 4000K | Beyaz | 40 ad. | 8,10 USD | |
| AP01-00930 | 9 W | 130 mm | 765 lm | 6500K | Beyaz | 40 ad. | 8,10 USD | |
| AP01-01200 | 12 W | 155 mm | 1020 lm | 3000K | Beyaz | 20 ad. | 9,40 USD | |
| AP01-01210 | 12 W | 155 mm | 1020 lm | 4000K | Beyaz | 20 ad. | 9,40 USD | |
| AP01-01230 | 12 W | 155 mm | 1020 lm | 6500K | Beyaz | 20 ad. | 9,40 USD | |
| AP01-01500 | 15 W | 175 mm | 1275 lm | 3000K | Beyaz | 20 ad. | 10,60 USD | |
| AP01-01510 | 15 W | 175 mm | 1275 lm | 4000K | Beyaz | 20 ad. | 10,60 USD | |
| AP01-01530 | 15 W | 175 mm | 1275 lm | 6500K | Beyaz | 20 ad. | 10,60 USD | |
| AP01-01534 | 15 W | 175 mm | 1275 lm | 6500K | Saten | 20 ad. | 15,00 USD | |
| AP01-01800 | 18 W | 205 mm | 1530 lm | 3000K | Beyaz | 20 ad. | 11,50 USD | |
| AP01-01810 | 18 W | 205 mm | 1530 lm | 4000K | Beyaz | 20 ad. | 11,50 USD | |
| AP01-01830 | 18 W | 205 mm | 1530 lm | 6500K | Beyaz | 20 ad. | 11,50 USD | |
| AP01-01834 | 18 W | 205 mm | 1530 lm | 6500K | Saten | 20 ad. | 17,50 USD | |
| AP01-02000 | 20 W | 220 mm | 1700 lm | 3000K | Beyaz | 20 ad. | 18,70 USD | |
| AP01-02010 | 20 W | 220 mm | 1700 lm | 4000K | Beyaz | 20 ad. | 18,70 USD | |
| AP01-02030 | 20 W | 220 mm | 1700 lm | 6500K | Beyaz | 20 ad. | 18,70 USD | |

LED Panel Armatürler

LED Panel Luminaires

Sıva Altı Yuvarlak LED Panel Arm. (Siyah Gövde)



ISO 9001



Çalışma Gerilimi : 220 V - 240 V
Aydınlatma Açısı : 115°



OSRAM LED Kullanılmıştır

| Kod | Güç | Kesim Ölçüsü | Işık Akısı | Renk Isısı | Gövde | Koli Mik. | Fiyat | |
|------------|------|--------------|------------|------------|-------|-----------|-----------|--|
| AP01-00301 | 3 W | 65 mm | 255 lm | 3000K | Siyah | 40 ad. | 5,40 USD | |
| AP01-00311 | 3 W | 65 mm | 255 lm | 4000K | Siyah | 40 ad. | 5,40 USD | |
| AP01-00331 | 3 W | 65 mm | 255 lm | 6500K | Siyah | 40 ad. | 5,40 USD | |
| AP01-00601 | 6 W | 105 mm | 510 lm | 3000K | Siyah | 40 ad. | 7,50 USD | |
| AP01-00611 | 6 W | 105 mm | 510 lm | 4000K | Siyah | 40 ad. | 7,50 USD | |
| AP01-00631 | 6 W | 105 mm | 510 lm | 6500K | Siyah | 40 ad. | 7,50 USD | |
| AP01-00901 | 9 W | 130 mm | 765 lm | 3000K | Siyah | 40 ad. | 9,90 USD | |
| AP01-00911 | 9 W | 130 mm | 765 lm | 4000K | Siyah | 40 ad. | 9,90 USD | |
| AP01-00931 | 9 W | 130 mm | 765 lm | 6500K | Siyah | 40 ad. | 9,90 USD | |
| AP01-01201 | 12 W | 155 mm | 1020 lm | 3000K | Siyah | 20 ad. | 11,50 USD | |
| AP01-01211 | 12 W | 155 mm | 1020 lm | 4000K | Siyah | 20 ad. | 11,50 USD | |
| AP01-01231 | 12 W | 155 mm | 1020 lm | 6500K | Siyah | 20 ad. | 11,50 USD | |
| AP01-01501 | 15 W | 175 mm | 1275 lm | 3000K | Siyah | 20 ad. | 12,50 USD | |
| AP01-01511 | 15 W | 175 mm | 1275 lm | 4000K | Siyah | 20 ad. | 12,50 USD | |
| AP01-01531 | 15 W | 175 mm | 1275 lm | 6500K | Siyah | 20 ad. | 12,50 USD | |
| AP01-01801 | 18 W | 205 mm | 1530 lm | 3000K | Siyah | 20 ad. | 14,10 USD | |
| AP01-01811 | 18 W | 205 mm | 1530 lm | 4000K | Siyah | 20 ad. | 14,10 USD | |
| AP01-01831 | 18 W | 205 mm | 1530 lm | 6500K | Siyah | 20 ad. | 14,10 USD | |
| AP01-02001 | 20 W | 220 mm | 1700 lm | 3000K | Siyah | 20 ad. | 21,60 USD | |
| AP01-02011 | 20 W | 220 mm | 1700 lm | 4000K | Siyah | 20 ad. | 21,60 USD | |
| AP01-02031 | 20 W | 220 mm | 1700 lm | 6500K | Siyah | 20 ad. | 21,60 USD | |

LED Panel Armatürler

LED Panel Luminaires

Sıva Üstü Kare LED Panel Arm. (Beyaz Gövde)

RoHS Compliant | CE | ISO 9001 | 30.000 hr | IP20 | 115°

| Kod | Güç | Ölçü (mm) | Işık Ak. | Renk I. | Gövde | Koli M. | Fiyat |
|------------|------|----------------|----------|---------|-------|---------|-----------|
| AP04-01200 | 12 W | 170 x 170 x 40 | 1020 lm | 3000K | Beyaz | 20 Ad. | 13,10 USD |
| AP04-01210 | 12 W | 170 x 170 x 40 | 1020 lm | 4000K | Beyaz | 20 Ad. | 13,10 USD |
| AP04-01230 | 12 W | 170 x 170 x 40 | 1020 lm | 6500K | Beyaz | 20 Ad. | 13,10 USD |
| AP04-01800 | 18 W | 220 x 220 x 40 | 1530 lm | 3000K | Beyaz | 20 Ad. | 16,90 USD |
| AP04-01810 | 18 W | 220 x 220 x 40 | 1530 lm | 4000K | Beyaz | 20 Ad. | 16,90 USD |
| AP04-01830 | 18 W | 220 x 220 x 40 | 1530 lm | 6500K | Beyaz | 20 Ad. | 16,90 USD |
| AP04-02400 | 24 W | 300 x 300 x 40 | 1870 lm | 3000K | Beyaz | 10 Ad. | 23,70 USD |
| AP04-02410 | 24 W | 300 x 300 x 40 | 1870 lm | 4000K | Beyaz | 10 Ad. | 23,70 USD |
| AP04-02430 | 24 W | 300 x 300 x 40 | 1870 lm | 6500K | Beyaz | 10 Ad. | 23,70 USD |
| AP04-03300 | 32 W | 400 x 400 x 40 | 2720 lm | 3000K | Beyaz | 10 Ad. | 50,00 USD |
| AP04-03310 | 32 W | 400 x 400 x 40 | 2720 lm | 4000K | Beyaz | 10 Ad. | 50,00 USD |
| AP04-03330 | 32 W | 400 x 400 x 40 | 2720 lm | 6500K | Beyaz | 10 Ad. | 50,00 USD |



Çalışma Gerilimi : 220 V- 240 V
Aydınlatma Açısı : 115°



Sıva Üstü Kare LED Panel Arm. (Siyah Gövde)

RoHS Compliant | CE | ISO 9001 | 30.000 hr | IP20 | 115°

| Kod | Güç | Ölçü (mm) | Işık Ak. | Renk I. | Gövde | Koli M. | Fiyat |
|------------|------|----------------|----------|---------|-------|---------|-----------|
| AP04-01201 | 12 W | 170 x 170 x 40 | 1020 lm | 3000K | Siyah | 20 Ad. | 14,80 USD |
| AP04-01211 | 12 W | 170 x 170 x 40 | 1020 lm | 4000K | Siyah | 20 Ad. | 14,80 USD |
| AP04-01231 | 12 W | 170 x 170 x 40 | 1020 lm | 6500K | Siyah | 20 Ad. | 14,80 USD |
| AP04-01801 | 18 W | 220 x 220 x 40 | 1530 lm | 3000K | Siyah | 20 Ad. | 18,10 USD |
| AP04-01811 | 18 W | 220 x 220 x 40 | 1530 lm | 4000K | Siyah | 20 Ad. | 18,10 USD |
| AP04-01831 | 18 W | 220 x 220 x 40 | 1530 lm | 6500K | Siyah | 20 Ad. | 18,10 USD |
| AP04-02401 | 24 W | 300 x 300 x 40 | 1870 lm | 3000K | Siyah | 10 Ad. | 26,20 USD |
| AP04-02411 | 24 W | 300 x 300 x 40 | 1870 lm | 4000K | Siyah | 10 Ad. | 26,20 USD |
| AP04-02431 | 24 W | 300 x 300 x 40 | 1870 lm | 6500K | Siyah | 10 Ad. | 26,20 USD |
| AP04-03301 | 32 W | 400 x 400 x 40 | 2720 lm | 3000K | Siyah | 10 Ad. | 53,00 USD |
| AP04-03311 | 32 W | 400 x 400 x 40 | 2720 lm | 4000K | Siyah | 10 Ad. | 53,00 USD |
| AP04-03331 | 32 W | 400 x 400 x 40 | 2720 lm | 6500K | Siyah | 10 Ad. | 53,00 USD |



Çalışma Gerilimi : 220 V- 240 V
Aydınlatma Açısı : 115°

LED Panel Armatürler

LED Panel Luminaires

Sıva Üstü Yuvarlak LED Panel Arm. (Beyaz Gövde)

RoHS Compliant | CE | ISO 9001 | 30.000 hr | IP20 | 115°

| Kod | Güç | Ölçü (mm) | Işık Ak. | Renk I. | Gövde | Koli M. | Fiyat |
|------------|------|-----------|----------|---------|-------|---------|-----------|
| AP03-01200 | 12 W | φ170 x 40 | 1020 lm | 3000K | Beyaz | 20 Ad. | 11,90 USD |
| AP03-01210 | 12 W | φ170 x 40 | 1020 lm | 4000K | Beyaz | 20 Ad. | 11,90 USD |
| AP03-01230 | 12 W | φ170 x 40 | 1020 lm | 6500K | Beyaz | 20 Ad. | 11,90 USD |
| AP03-01800 | 18 W | φ220 x 40 | 1530 lm | 3000K | Beyaz | 20 Ad. | 15,00 USD |
| AP03-01810 | 18 W | φ220 x 40 | 1530 lm | 4000K | Beyaz | 20 Ad. | 15,00 USD |
| AP03-01830 | 18 W | φ220 x 40 | 1530 lm | 6500K | Beyaz | 20 Ad. | 15,00 USD |
| AP03-02400 | 24 W | φ300 x 40 | 2040 lm | 3000K | Beyaz | 10 Ad. | 21,90 USD |
| AP03-02410 | 24 W | φ300 x 40 | 2040 lm | 4000K | Beyaz | 10 Ad. | 21,90 USD |
| AP03-02430 | 24 W | φ300 x 40 | 2040 lm | 6500K | Beyaz | 10 Ad. | 21,90 USD |



Çalışma Gerilimi : 220 V- 240 V
Aydınlatma Açısı : 115°



Sıva Üstü Yuvarlak LED Panel Arm. (Siyah Gövde)

RoHS Compliant | CE | ISO 9001 | 30.000 hr | IP20 | 115°

| Kod | Güç | Ölçü (mm) | Işık Ak. | Renk I. | Gövde | Koli M. | Fiyat |
|------------|------|-----------|----------|---------|-------|---------|-----------|
| AP03-01201 | 12 W | φ170 x 40 | 1020 lm | 3000K | Siyah | 20 Ad. | 13,10 USD |
| AP03-01211 | 12 W | φ170 x 40 | 1020 lm | 4000K | Siyah | 20 Ad. | 13,10 USD |
| AP03-01231 | 12 W | φ170 x 40 | 1020 lm | 6500K | Siyah | 20 Ad. | 13,10 USD |
| AP03-01801 | 18 W | φ220 x 40 | 1530 lm | 3000K | Siyah | 20 Ad. | 16,20 USD |
| AP03-01811 | 18 W | φ220 x 40 | 1530 lm | 4000K | Siyah | 20 Ad. | 16,20 USD |
| AP03-01831 | 18 W | φ220 x 40 | 1530 lm | 6500K | Siyah | 20 Ad. | 16,20 USD |
| AP03-02401 | 24 W | φ300 x 40 | 2040 lm | 3000K | Siyah | 10 Ad. | 24,40 USD |
| AP03-02411 | 24 W | φ300 x 40 | 2040 lm | 4000K | Siyah | 10 Ad. | 24,40 USD |
| AP03-02431 | 24 W | φ300 x 40 | 2040 lm | 6500K | Siyah | 10 Ad. | 24,40 USD |



Çalışma Gerilimi : 220 V- 240 V
Aydınlatma Açısı : 115°

Modüler Spot Armatürler

Modular Lighting Fixtures

Terra Alüminyum Spot Armatür

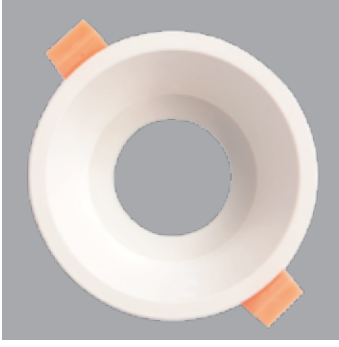

RoHS Compliant | CE | 65mm | IP20

Kesim Ölçüsü : 65 mm
Koli Miktarı : 100 ad

Terra Alüminyum Spot Armatür

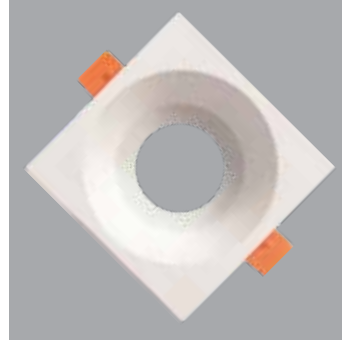

RoHS Compliant | CE | 65mm | IP20

Kesim Ölçüsü : 65 mm
Koli Miktarı : 100 ad

Terra Alüminyum Spot Armatür

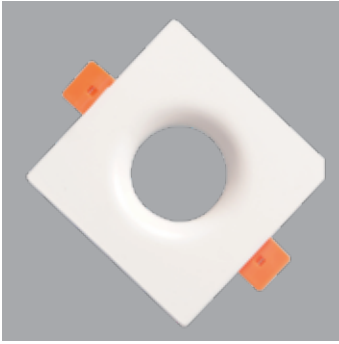

RoHS Compliant | CE | 70mm | IP20

Kesim Ölçüsü : 70 mm
Koli Miktarı : 100 ad

Terra Alüminyum Spot Armatür

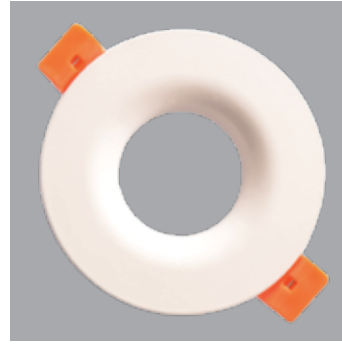

RoHS Compliant | CE | 75mm | IP20

Kesim Ölçüsü : 75 mm
Koli Miktarı : 100 ad

Terra Alüminyum Spot Armatür

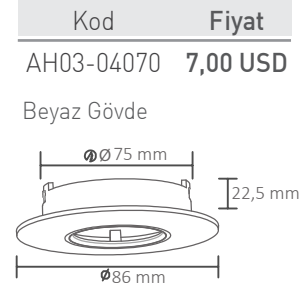
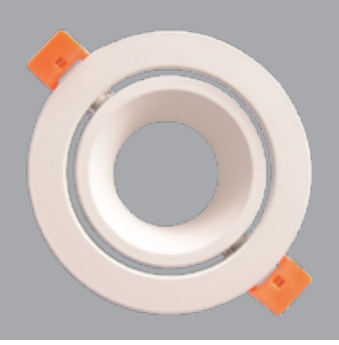

RoHS Compliant | CE | 75mm | IP20

Kesim Ölçüsü : 75 mm
Koli Miktarı : 100 ad

Terra Alüminyum Spot Armatür

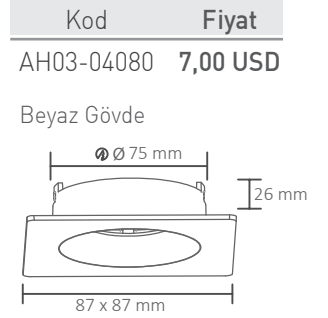
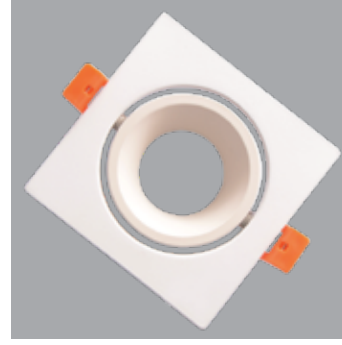

RoHS Compliant | CE | 75mm | IP20

Kesim Ölçüsü : 75 mm
Koli Miktarı : 100 ad

Terra Alüminyum Spot Armatür

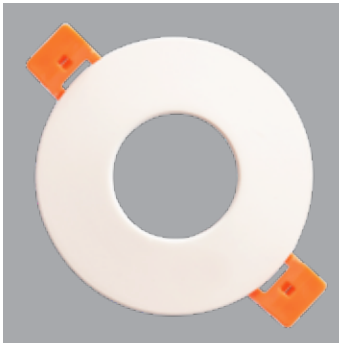

RoHS Compliant | CE | 65mm | IP20

Kesim Ölçüsü : 65 mm
Koli Miktarı : 100 ad

Terra Alüminyum Spot Armatür

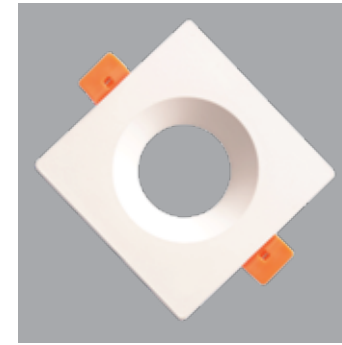

RoHS Compliant | CE | 70mm | IP20

Kesim Ölçüsü : 70 mm
Koli Miktarı : 100 ad

Terra Alüminyum Spot Armatür



| Kod | Fiyat |
|------------|----------|
| AH03-04011 | 7,00 USD |



RoHS Compliant | CE | 65mm | IP20

Kesim Ölçüsü: 65 mm
Koli Miktarı : 100 ad

Terra Alüminyum Spot Armatür

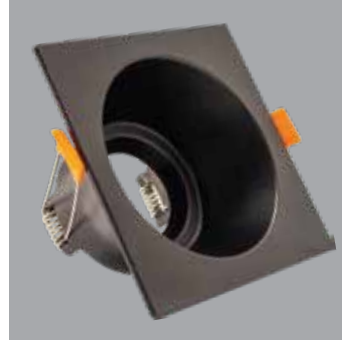

| Kod | Fiyat |
|------------|----------|
| AH03-04021 | 7,00 USD |

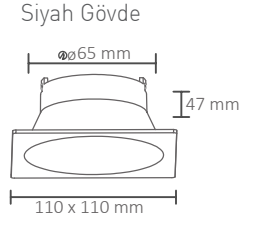

RoHS Compliant | CE | 65mm | IP20

Kesim Ölçüsü : 65 mm
Koli Miktarı : 100 ad

Terra Alüminyum Spot Armatür

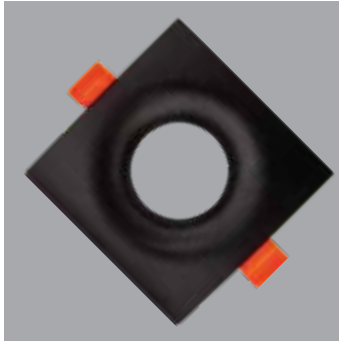

| Kod | Fiyat |
|------------|----------|
| AH03-04041 | 7,00 USD |

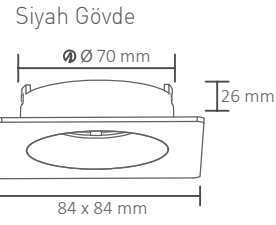

RoHS Compliant | CE | 70mm | IP20

Kesim Ölçüsü : 70 mm
Koli Miktarı : 100 ad

Terra Alüminyum Spot Armatür



| Kod | Fiyat |
|------------|----------|
| AH03-04051 | 7,00 USD |

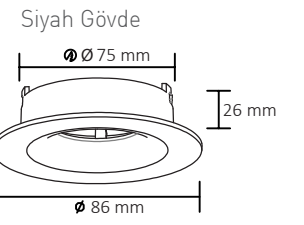

RoHS Compliant | CE | 75mm | IP20

Kesim Ölçüsü : 75 mm
Koli Miktarı : 100 ad

Terra Alüminyum Spot Armatür

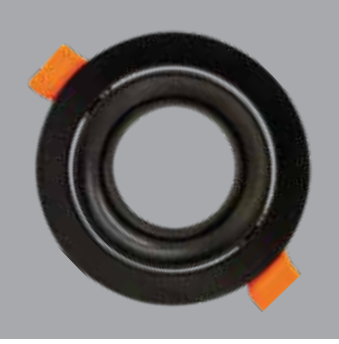

| Kod | Fiyat |
|------------|----------|
| AH03-04071 | 8,30 USD |

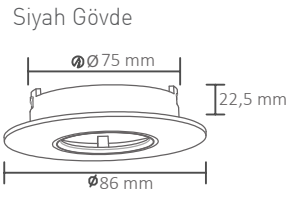

RoHS Compliant | CE | 75mm | IP20

Kesim Ölçüsü : 75 mm
Koli Miktarı : 100 ad

Terra Alüminyum Spot Armatür

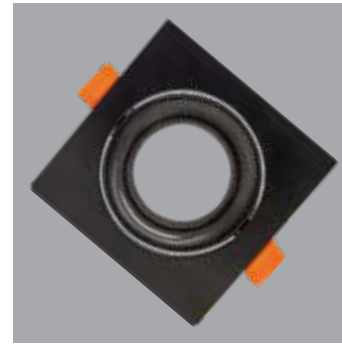

| Kod | Fiyat |
|------------|----------|
| AH03-04081 | 8,30 USD |

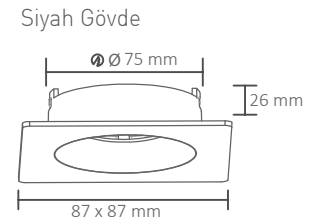

RoHS Compliant | CE | 75mm | IP20

Kesim Ölçüsü : 75 mm
Koli Miktarı : 100 ad

Terra 8W COB LED Aydınlatma Modül

RoHS Compliant | CE | IP20



| Kod | Renk | Fiyat |
|------------|-------|-----------|
| AH06-00001 | 3000K | 12,00 USD |
| AH06-00011 | 4000K | 12,00 USD |
| AH06-00031 | 6500K | 12,00 USD |

Gerilim : 220 V
Güç : 8 W
Işık Akısı : 640 lm
Aydınlatma Açısı : 38°
Koli Miktarı : 50 ad

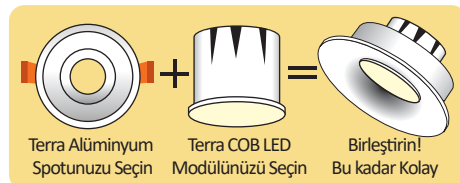
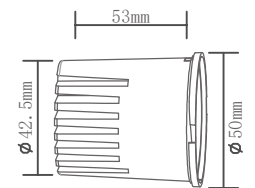

Modüler Spot Armatürler

Modular Lighting Fixtures

Modüler Sistemli Spot Armatür

Materyal: PC IP20

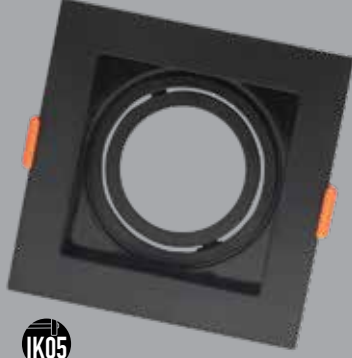

IK05

| Kod | Fiyat |
|------------|----------|
| AH03-05001 | 3,90 USD |

Gövde: Siyah

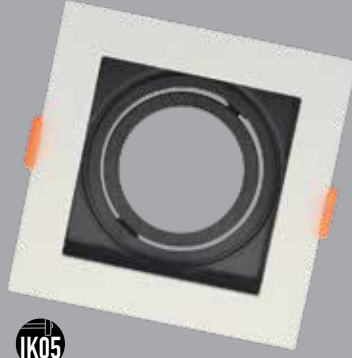

IK05

| Kod | Fiyat |
|------------|----------|
| AH03-05009 | 3,90 USD |

Gövde: Siyah/Beyaz



IK05

| Kod | Fiyat |
|------------|----------|
| AH03-05000 | 3,90 USD |

Gövde: Beyaz



Konnektör (Bağlantı Aparatı)

| Kod | Fiyat |
|------------|----------|
| AH03-90001 | 0,81 USD |

Koli Mik.: 50 Ad. / Materyal: PC

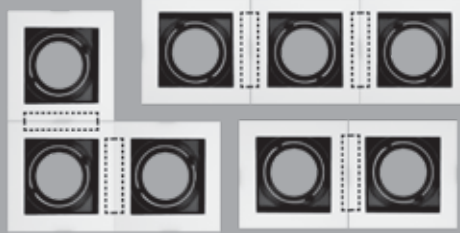

Konnektörler yardımıyla birden fazla ürünü farklı şekilde birbirine bağlayabilirsiniz.

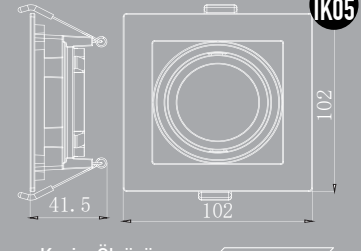

Kesim Ölçüsü:
95 mm X 95 mm



LED Havuz ve Yer Armatürleri

LED Pool and Floor Fixtures

LED Havuz Armatürü

RoHS Compliant | CE | IP68



| Kod | Fiyat |
|------------|-----------|
| AH13-05600 | 34,70 USD |

225 mm beton kasa iç çap.
300 mm çerçeve çap.
Çerçeve ABS, Ring ABS,
Ampul kapağı ve kasa moblen.
Çerçeve vida 6x60 inox.

Somun pul, 2,2X13 YSB inox
çerçeve vida.
Yassı conta, dar ve geniş kablo bağma conta
2,25 mt 2x1,5 TTR veya 4x10 TTR kablo

BOP
PAR56 Ampul uyumlu.

36W LED Havuz Ampülü

RoHS Compliant | CE | 30.000 hr | IP67



Koli Miktarı: 12 Ad.

| Kod | Renk | Fiyat |
|------------|-------|-----------|
| AA31-83620 | 3000K | 44,00 USD |
| AA31-83623 | 6500K | 44,00 USD |
| AA31-83626 | Mavi | 44,00 USD |
| AA31-83629 | RGB | 45,00 USD |

AC/DC Voltaj seçenekleri
Power LED ve SMD LED

Alüminyum PCB
Dişli cam case ile arasına silikon conta
kullanılarak sızdırmazlık sağlanmıştır.

Akısm kontrol ünitesi

Ölçüler: ø156 mm x 63,6 mm

Gerilim 12 V
Güç 36 W
Duy PAR56
Işık Akısı 4500 lm
(3000K ve 6500K)

LED Havuz ve Yer Armatürleri

LED Pool and Floor Fixtures

36W Flat Sıva Üstü Slim LED Havuz Armatürü

RoHS Compliant | CE | 30.000 hr | IP68



Koli Miktarı: 12 Ad.

| Kod | Renk | Fiyat |
|------------|-------|-----------|
| AH08-03600 | 3000K | 67,20 USD |
| AH08-03630 | 6500K | 67,20 USD |
| AH08-03660 | Mavi | 67,20 USD |

Ölçüler: ø260 mm x 260 mm

Gerilim : 12 V
Güç : 36 W
Işık Akısı : 4500 lm
(3000K ve 6500K)

PAR56 özelliikte.

Dişli case ile arasına silikon conta kullanılarak sızdırmazlık sağlanmıştır.

Alüminyum PCB

Akım kontrol ünitesi

9W LED Havuz Armatürü

RoHS Compliant | CE | 30.000 hr | IP68



Koli Miktarı: 12 Ad.

Siyah Gövde

| Kod | Renk | Fiyat |
|------------|-------|-----------|
| AH08-00901 | 3000K | 80,00 USD |
| AH08-00931 | 6500K | 80,00 USD |
| AH08-00951 | Yeşil | 80,00 USD |
| AH08-00961 | Mavi | 80,00 USD |
| AH08-00991 | RGB | 81,00 USD |

Gerilim : 12 V
Güç : 9 W
Işık Akısı : 1200 lm
(3000K ve 6500K)

Beyaz Gövde

| Kod | Renk | Fiyat |
|------------|-------|-----------|
| AH08-00900 | 3000K | 80,00 USD |
| AH08-00930 | 6500K | 80,00 USD |
| AH08-00950 | Yeşil | 80,00 USD |
| AH08-00960 | Mavi | 80,00 USD |
| AH08-00990 | RGB | 81,00 USD |

Ölçüler: ø145 mm x 95 mm x Ayak: 50 mm

6W LED Havuz Armatürü



Paslanmaz Çelik

Saten Kasa Koli Miktarı: 12 Ad.

| Kod | Renk | Fiyat |
|------------|-------|-----------|
| AH08-00603 | 3000K | 79,00 USD |
| AH08-00633 | 6500K | 79,00 USD |
| AH08-00653 | Yeşil | 79,00 USD |
| AH08-00663 | Mavi | 79,00 USD |
| AH08-00693 | RGB | 81,00 USD |

Ölçüler: ø105 mm x 70 mm
Ayak: 55 mm

Gerilim : 12 V
Güç : 6 W
Işık Akısı : 900 lm
(3000K ve 6500K)

RoHS Compliant | CE | 30.000 hr | IP68

12W LED Yer Armatürü



Paslanmaz Çelik

Saten Kasa

| Kod | Renk | Fiyat |
|------------|-------|------------|
| AH08-01203 | 3000K | 142,00 USD |
| AH08-01233 | 6500K | 142,00 USD |
| AH08-01253 | Yeşil | 142,00 USD |
| AH08-01263 | Mavi | 142,00 USD |
| AH08-01293 | RGB | 144,00 USD |

Ölçüler: ø175 mm x 50 mm
35-10 Köpük fiskeye uyumlu.

Gerilim : 12 V
Güç : 12 W
Işık Akısı : 1600 lm
(3000K ve 6500K)

RoHS Compliant | CE | 30.000 hr | IP68

6W LED Havuz Armatürü



| Kod | Renk | Fiyat |
|----------|------------|-----------|
| 6801-002 | Ilık Beyaz | 50,00 USD |

Trafosuz

Gerilim : 12 V DC
Güç : 6 W
Koli Miktarı : 6 ad

RoHS Compliant | CE | 30.000 hr | IP67

7W LED Yer Armatürü



| Kod | Renk | Fiyat |
|----------|-------|-----------|
| 6605-001 | Beyaz | 40,00 USD |
| 6605-003 | Mavi | 40,00 USD |

Ölçüler: 120 mm x 206 mm
Gerilim : 220 V
Güç : 7 W
Koli Miktarı : 8 ad

RoHS Compliant | CE | 30.000 hr | IP67

LED Sokak Armatürleri

LED Street Fixtures

60W LED Solar Sokak Armatürü

RoHS Compliant CE ISO 9001 IP65



| Kod | Renk I. | Fiyat |
|------------|---------|-----------|
| AT42-06031 | 6500K | 89,00 USD |

120 Ad. LED / 5 AH
Güneş Paneli Bataryası: 6V/8W
Gövde Rengi: Siyah

Çalışma Isısı: -10 °C / +50 °C

Gerilim : 3,2 V
Kapasite : 60 W
Işık Akısı : 900 lm
Aydınlatma Açısı : 120°
Koli Miktarı : 8 ad

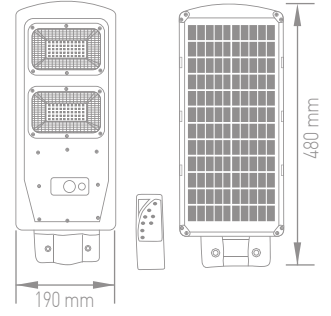

Güneş enerjisi ile sarj olan yüksek kaliteli pil teknolojisi.
Elektrik bağlantısı gerektirmeyen kolay kurulum.
Çevre dostu, enerji tasarruflu LED.
Yağmur geçirmez ABS Plastik Kasa.

90W LED Solar Sokak Armatürü

RoHS Compliant CE ISO 9001 IP65



| Kod | Renk I. | Fiyat |
|------------|---------|------------|
| AT42-09031 | 6500K | 102,00 USD |

180 Ad. LED / 10 AH
Güneş Paneli Bataryası: 6V/12W
Gövde Rengi: Siyah

Çalışma Isısı: -10 °C / +50 °C

Gerilim : 3,2 V
Kapasite : 90 W
Işık Akısı : 1120 lm
Aydınlatma Açısı : 120°
Koli Miktarı : 6 ad

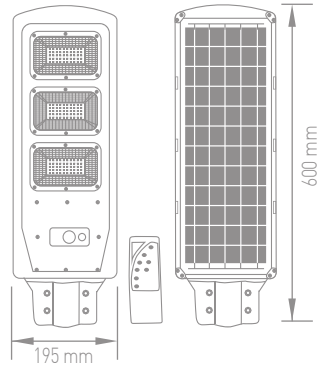

Güneş enerjisi ile sarj olan yüksek kaliteli pil teknolojisi.
Elektrik bağlantısı gerektirmeyen kolay kurulum.
Çevre dostu, enerji tasarruflu LED.
Yağmur geçirmez ABS Plastik Kasa.

120W LED Solar Sokak Armatürü

RoHS Compliant CE ISO 9001 IP65



| Kod | Renk I. | Fiyat |
|------------|---------|------------|
| AT42-09131 | 6500K | 144,00 USD |

240 Ad. LED / 15 AH
Güneş Paneli Bataryası: 6V/16W
Gövde Rengi: Siyah

Çalışma Isısı: -10 °C / +50 °C

Gerilim : 3,2 V
Kapasite : 120 W
Işık Akısı : 1250 lm
Aydınlatma Açısı : 120°
Koli Miktarı : 4 ad

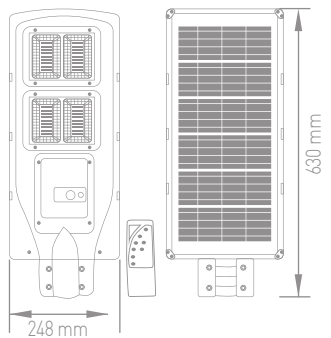

Güneş enerjisi ile sarj olan yüksek kaliteli pil teknolojisi.
Elektrik bağlantısı gerektirmeyen kolay kurulum.
Çevre dostu, enerji tasarruflu LED.
Yağmur geçirmez ABS Plastik Kasa.

LED Sokak Armatürleri

LED Street Fixtures

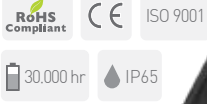

Gövde ve yan parçalar yüksek ısı geçirgenlik özelliğine sahip alüminyum enjeksiyon malzemeden imal edilmiş, yüzey reaksiyonu ve kromat kaplama dış ortama dayanıklı elektrostatik toz boya ile boyanmıştır. Lensler yüksek ısıya dayanıklı PMAA malzemedir ve bunlar çeşitli yol standartlarına uygun ışık dağılımına sahiptir. Tüm vida ve bağlantı parçaları paslanmaz olarak kullanılır. Besleme kablosu lastik yalıtımlıdır ve kablo giriş rakoru pirinç nikel kaplıdır. Sürücü ünitesi LED kısmından bağımsızdır ve arıza durumunda kolayca değiştirilebilir.

Teknik Özellikler

| | | | |
|------------------------|----------------|----------------|----------------|
| Güç Tüketimi | 50 W +/- 5% | 75 W +/- 5% | 110 W +/- 5% |
| Besleme Gerilimi | AC 220-240 V | AC 220-240 V | AC 220-240 V |
| Besleme Akımı | 0,217 A | 0,326 A | 0,478 A |
| Frekans | 50-60 Hz | 50-60 Hz | 50-60 Hz |
| Güç Faktörü Düzeltmesi | 0,95 PF | 0,95 PF | 0,95 PF |
| Driver Verimliliği | 90% | 90% | 90% |
| Lümen/Watt | 100 lm/W | 100 lm/W | 100 lm/W |
| Aydınlatma Açısı | Asimetrik | Asimetrik | Asimetrik |
| Led Tipi | 3030 | 3030 | 3030 |
| Renk Isısı | 3000-4000-6500 | 3000-4000-6500 | 3000-4000-6500 |
| CRI | Ra ≥ 70-80 | Ra ≥ 70-80 | Ra ≥ 70-80 |
| Işık Akısı | 5,000 lm | 7,500 lm | 11,000 lm |
| Çalışma Isısı | -20/+45 °C | -20/+45 °C | -20/+45 °C |
| IP | IP 65 | IP 65 | IP 65 |
| Garanti | 2 Yıl | 2 Yıl | 2 Yıl |
| Led Ömrü | 30.000 Saat | 30.000 Saat | 30.000 Saat |

50 W LED Sokak Armatürü



| Kod | Renk I. | I. Akısı | Fiyat |
|------------|---------|----------|-----------|
| AT41-05000 | 3000K | 4800 lm | 57,50 USD |
| AT41-05010 | 4000K | 4900 lm | 57,50 USD |
| AT41-05030 | 6500K | 5000 lm | 57,50 USD |

Koli Miktarı: 10 Ad.



75 W LED Sokak Armatürü



| Kod | Renk I. | I. Akısı | Fiyat |
|------------|---------|----------|-----------|
| AT41-08000 | 3000K | 7300 lm | 95,00 USD |
| AT41-08010 | 4000K | 7400 lm | 95,00 USD |
| AT41-08030 | 6500K | 7500 lm | 95,00 USD |

Koli Miktarı: 10 Ad.



110 W LED Sokak Armatürü



| Kod | Renk I. | I. Akısı | Fiyat |
|------------|---------|----------|------------|
| AT41-09100 | 3000K | 10800 lm | 132,00 USD |
| AT41-09110 | 4000K | 10900 lm | 132,00 USD |
| AT41-09130 | 6500K | 11000 lm | 132,00 USD |

Koli Miktarı: 10 Ad.



LED Wallwasherlar

LED Wallwashers



Gövde profili 6063 serisi alüminyum ekstrüzyon üzeri 20 micron eloksal kaplamalı olup atmosferik şartlara uygun max koruma sağlayabilmektedir. Yan kapaklar alüminyum enjeksiyon malzemeden yüzey işlemleri ve kromajlama yapılarak harici ortama dayanıklı elektrostatik toz boya ile boyanmıştır. Sızdırmazlık elemanları TPV malzemeden üretilmiş olup mükemmel izolasyon sağlamaktadır. IP68 süper etanj pirinç nikel kablo rekoru basınç dengelemeli yağışmayı önleyen tahliye ventili ve kauçuk izoleli besleme kablosu standart ürün özellikleri içerisinde yer almaktadır. 10-30-45 derece standart yüksek ışık geçirgenlikli PMMA lens ve 4mm temperli cam ile cepheler ve objeler için farklı ışık efektleri sunulabilmektedir.



Teknik Özellikler

| Güç Tüketimi | 6 W +/- 5% | 9 W +/- 5% | 12 W +/- 5% | 18 W +/- 5% | 36 W +/- 5% |
|--------------------------|--------------|--------------|--------------|--------------|--------------|
| Besleme Gerilimi | AC 220-240 V | AC 220-240 V | AC 220-240 V | AC 220-240 V | AC 220-240 V |
| Besleme Akımı | 26 mA | 39 mA | 52 mA | 78 mA | 156 mA |
| Frekans | 50-60 Hz | 50-60 Hz | 50-60 Hz | 50-60 Hz | 50-60 Hz |
| Güç Faktörü Düzeltmesi | 0,60 Pf | 0,60 Pf | 0,60 Pf | 0,60 Pf | 0,60 Pf |
| Driver Verimliliği | 85 % | 85 % | 85 % | 90 % | 90 % |
| Lümen/Watt | 80 lm/W | 80 lm/W | 80 lm/W | 80 lm/W | 80 lm/W |
| Aydınlatma Açısı | 15°-30°-45° | 15°-30°-45° | 15°-30°-45° | 15°-30°-45° | 15°-30°-45° |
| Led Tipi | 3030 | 3030 | 3030 | 3030 | 3030 |
| CRI | Ra≥80 | Ra≥80 | Ra≥80 | Ra≥80 | Ra≥80 |
| Işık Akısı | 480 lm | 720 lm | 960 lm | 1,440 lm | 2,880 lm |
| Çalışma Isısı | -20/+45 °C | -20/+45 °C | -20/+45 °C | -20/+45 °C | -20/+45 °C |
| IP | IP 65 | IP 65 | IP 65 | IP 65 | IP 65 |
| Garanti | 2 Yıl | 2 Yıl | 2 Yıl | 2 Yıl | 2 Yıl |
| Led Ömrü | 30.000 Saat | 30.000 Saat | 30.000 Saat | 30.000 Saat | 30.000 Saat |
| Boyutları (mm) (uzunluk) | 180 mm | 276 mm | 338 mm | 480 mm | 945 mm |

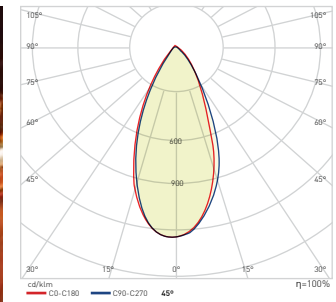
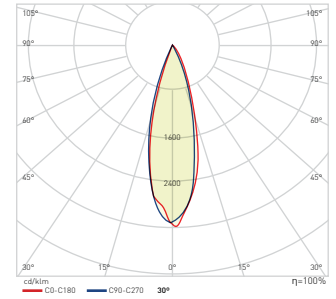
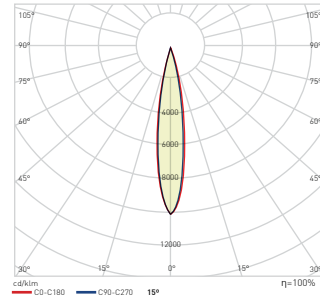
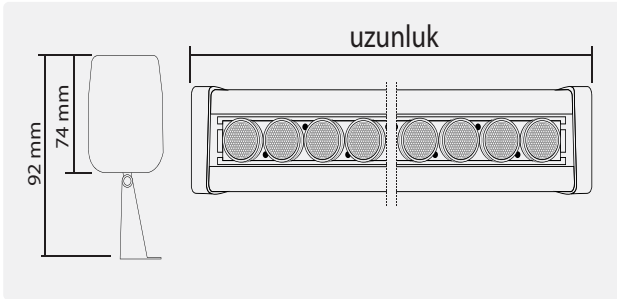

LED Wallwasherlar

LED Wallwashers

6 W LED Wallwasher

RoHS Compliant

CE

ISO 9001

30.000 hr

IP65



| Kod | Güç | Renk Isısı | Std. Aç | Fiyat |
|------------|-----|------------|---------|-----------|
| AT20-00603 | 6 W | 3000K | 30° | 33,00 USD |
| AT20-00633 | 6 W | 6500K | 30° | 33,00 USD |
| AT20-00643 | 6 W | Kırmızı | 30° | 33,00 USD |
| AT20-00653 | 6 W | Yeşil | 30° | 33,00 USD |
| AT20-00663 | 6 W | Mavi | 30° | 33,00 USD |
| AT20-00673 | 6 W | Sarı | 30° | 33,00 USD |
| AT20-00683 | 6 W | Amber | 30° | 33,00 USD |
| AT20-00693 | 6 W | RGB | 30° | 60,00 USD |

Koli Miktarı:
12 Ad.

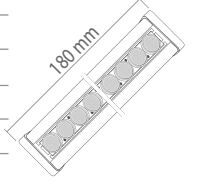

9 W LED Wallwasher

RoHS Compliant

CE

ISO 9001

30.000 hr

IP65

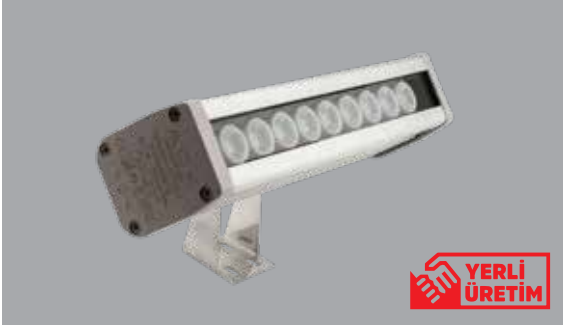

| Kod | Güç | Renk Isısı | Std. Aç | Fiyat |
|------------|-----|------------|---------|-----------|
| AT20-00903 | 9 W | 3000K | 30° | 40,70 USD |
| AT20-00933 | 9 W | 6500K | 30° | 40,70 USD |
| AT20-00943 | 9 W | Kırmızı | 30° | 40,70 USD |
| AT20-00953 | 9 W | Yeşil | 30° | 40,70 USD |
| AT20-00963 | 9 W | Mavi | 30° | 40,70 USD |
| AT20-00973 | 9 W | Sarı | 30° | 40,70 USD |
| AT20-00983 | 9 W | Amber | 30° | 40,70 USD |
| AT20-00993 | 9 W | RGB | 30° | 72,00 USD |

Koli Miktarı:
12 Ad.

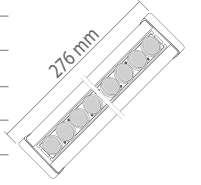

12 W LED Wallwasher

RoHS Compliant

CE

ISO 9001

30.000 hr

IP65



| Kod | Güç | Renk Isısı | Std. Aç | Fiyat |
|------------|------|------------|---------|-----------|
| AT20-01203 | 12 W | 3000K | 30° | 49,50 USD |
| AT20-01233 | 12 W | 6500K | 30° | 49,50 USD |
| AT20-01243 | 12 W | Kırmızı | 30° | 49,50 USD |
| AT20-01253 | 12 W | Yeşil | 30° | 49,50 USD |
| AT20-01263 | 12 W | Mavi | 30° | 49,50 USD |
| AT20-01273 | 12 W | Sarı | 30° | 49,50 USD |
| AT20-01283 | 12 W | Amber | 30° | 49,50 USD |
| AT20-01293 | 12 W | RGB | 30° | 77,00 USD |

Koli Miktarı:
6 Ad.

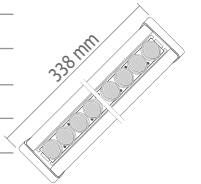

18 W LED Wallwasher

RoHS Compliant

CE

ISO 9001

30.000 hr

IP65

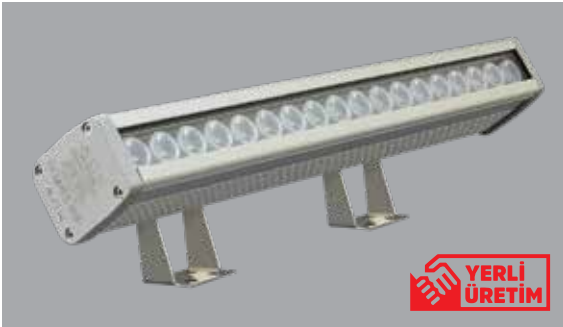

| Kod | Güç | Renk Isısı | Std. Aç | Fiyat |
|------------|------|------------|---------|------------|
| AT20-01803 | 18 W | 3000K | 30° | 67,70 USD |
| AT20-01833 | 18 W | 6500K | 30° | 67,70 USD |
| AT20-01843 | 18 W | Kırmızı | 30° | 67,70 USD |
| AT20-01853 | 18 W | Yeşil | 30° | 67,70 USD |
| AT20-01863 | 18 W | Mavi | 30° | 67,70 USD |
| AT20-01873 | 18 W | Sarı | 30° | 67,70 USD |
| AT20-01883 | 18 W | Amber | 30° | 67,70 USD |
| AT20-01893 | 18 W | RGB | 30° | 100,00 USD |

Koli Miktarı:
6 Ad.

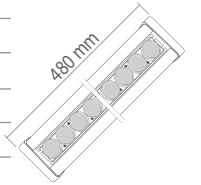

36 W LED Wallwasher

RoHS Compliant

CE

ISO 9001

30.000 hr

IP65

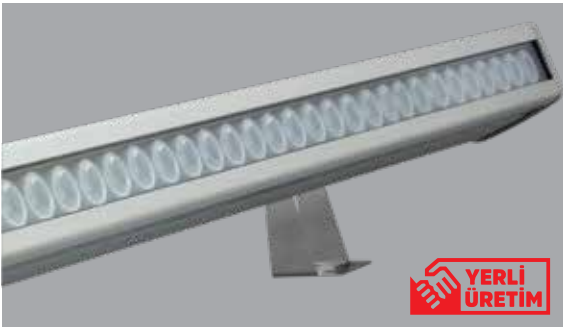

| Kod | Güç | Renk Isısı | Std. Aç | Fiyat |
|------------|------|------------|---------|------------|
| AT20-03603 | 36 W | 3000K | 30° | 99,00 USD |
| AT20-03633 | 36 W | 6500K | 30° | 99,00 USD |
| AT20-03643 | 36 W | Kırmızı | 30° | 99,00 USD |
| AT20-03653 | 36 W | Yeşil | 30° | 99,00 USD |
| AT20-03663 | 36 W | Mavi | 30° | 99,00 USD |
| AT20-03673 | 36 W | Sarı | 30° | 99,00 USD |
| AT20-03683 | 36 W | Amber | 30° | 99,00 USD |
| AT20-03693 | 36 W | RGB | 30° | 143,00 USD |

Koli Miktarı:
6 Ad.

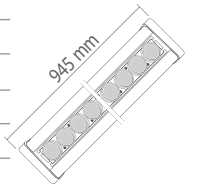

LED Projektörler

LED Floodlights

Alüminyum gövde ve çerçeve. Paslanmaz aksesuar. 4mm tamperli cam. Anodize alüminyum reflektör. SMD dizgili yüksek verimli ledler. Direkt şebeke besleme özelliği ile driver kaynaklı arızaların ortadan kaldırılarak yüksek power factor ve yüksek armatür verimi sunmaktadır. 10 W dan 400 W'a kadar geniş güç ve lümen seçenekleri sunmaktadır.



Teknik Özellikler



| Güç Tüketimi | 10 W +/- 5% | 20 W +/- 5% | 30 W +/- 5% | 50 W +/- 5% |
|------------------------|--------------|--------------|--------------|--------------|
| Besleme Gerilimi | AC 220-240 V | AC 220-240 V | AC 220-240 V | AC 220-240 V |
| Besleme Akımı | 0,043 A | 0,086 A | 0,130 A | 0,217 A |
| Frekans | 50-60 Hz | 50-60 Hz | 50-60 Hz | 50-60 Hz |
| Güç Faktörü Düzeltmesi | 0,9 PF | 0,9 PF | 0,9 PF | 0,9 PF |
| Lümen/Watt | 90 lm/W | 90 lm/W | 90 lm/W | 90 lm/W |
| Aydınlatma Açısı | 115 ° | 115 ° | 115 ° | 115 ° |
| Led Tipi | 2835 mm | 2835 mm | 2835 mm | 2835 mm |
| CRI | Ra≥80 | Ra ≥80 | Ra≥80 | Ra≥80 |
| Işık Akısı | 900 lm | 1,800 lm | 2700 lm | 4,500 lm |
| Çalışma Isısı | -20/+45 °C | -20/+45 °C | -20/+45 °C | -20/+45 °C |
| IP | IP65 | IP65 | IP65 | IP65 |
| Garanti | 2 yıl | 2 yıl | 2 yıl | 2 yıl |
| Led Ömrü | 30.000 Saat | 30.000 Saat | 30.000 Saat | 30.000 Saat |

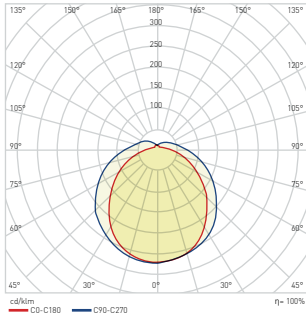
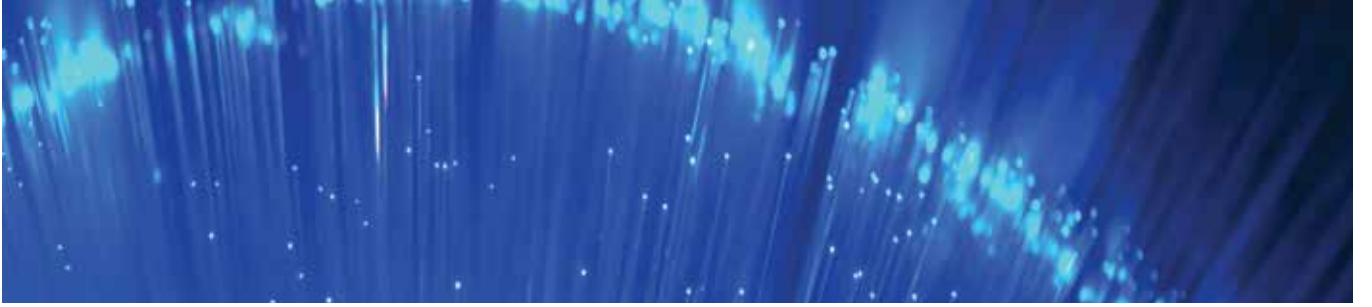

| Güç Tüketimi | 70 W +/- 5% | 100 W +/- 5% | 150 W +/- 5% | 200 W +/- 5% | 400 W +/- 5% |
|------------------------|--------------|--------------|--------------|--------------|--------------|
| Besleme Gerilimi | AC 220-240 V | AC 220-240 V | AC 220-240 V | AC 220-240 V | AC 220-240 V |
| Besleme Akımı | 0,304 A | 0,434 A | 0,652 A | 0,869 A | 1,739 A |
| Frekans | 50-60 Hz | 50-60 Hz | 50-60 Hz | 50-60 Hz | 50-60 Hz |
| Güç Faktörü Düzeltmesi | 0,9 PF | 0,9 PF | 0,9 PF | 0,9 PF | 0,9 PF |
| Lümen/Watt | 90 lm/W | 90 lm/W | 90 lm/W | 90 lm/W | 90 lm/W |
| Aydınlatma Açısı | 115 ° | 115 ° | 115 ° | 115 ° | 115 ° |
| Led Tipi | 2835 mm | 2835 mm | 2835 mm | 2835 mm | 2835 mm |
| CRI | Ra≥80 | Ra≥80 | Ra≥80 | Ra≥80 | Ra≥80 |
| Işık Akısı | 6,300 lm | 9,000 lm | 13,500 lm | 18,000 lm | 36,000 lm |
| Çalışma Isısı | -20+45 °C | -20+45 °C | -20+45 °C | -20+45 °C | -20+45 °C |
| IP | IP65 | IP65 | IP65 | IP65 | IP65 |
| Garanti | 2 yıl | 2 yıl | 2 yıl | 2 yıl | 2 yıl |
| Led Ömrü | 30.000 Saat | 30.000 Saat | 30.000 Saat | 30.000 Saat | 30.000 Saat |

10 W LED Projektör

RoHS Compliant | CE | 30.000 hr | IP65



| Kod | Renk I. | I. Akısı | Fiyat |
|------------|---------|----------|-----------|
| AT61-01002 | 3000K | 880 lm | 11,00 USD |
| AT61-01032 | 6500K | 900 lm | 11,00 USD |
| AT61-01052 | Yeşil | - | 13,00 USD |

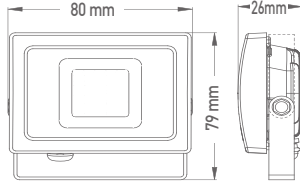

Gerilim : 220 V
Güç : 10 W
Koli Miktarı : 30 Ad

YERLİ ÜRETİM

20 W LED Projektör

RoHS Compliant | CE | 30.000 hr | IP65



| Kod | Renk I. | I. Akısı | Fiyat |
|------------|---------|----------|-----------|
| AT61-02002 | 3000K | 1750 lm | 18,00 USD |
| AT61-02032 | 6500K | 1800 lm | 18,00 USD |
| AT61-02052 | Yeşil | - | 20,00 USD |
| AT61-02082 | Amber | - | 20,00 USD |

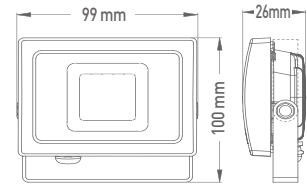

Gerilim : 220 V
Güç : 20 W
Koli Miktarı : 30 Ad

YERLİ ÜRETİM

30 W LED Projektör

RoHS Compliant | CE | 30.000 hr | IP65



| Kod | Renk I. | I. Akısı | Fiyat |
|------------|---------|----------|-----------|
| AT61-03002 | 3000K | 2650 lm | 24,50 USD |
| AT61-03032 | 6500K | 2700 lm | 24,50 USD |
| AT61-03052 | Yeşil | - | 27,00 USD |

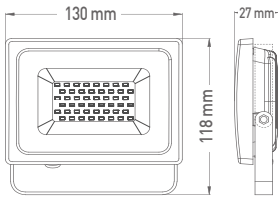

Gerilim : 220 V
Güç : 30 W
Koli Miktarı : 16 Ad

YERLİ ÜRETİM

50 W LED Projektör

RoHS Compliant | CE | 30.000 hr | IP65



| Kod | Renk I. | I. Akısı | Fiyat |
|------------|---------|----------|-----------|
| AT61-05002 | 3000K | 4400 lm | 35,00 USD |
| AT61-05032 | 6500K | 4500 lm | 35,00 USD |
| AT61-05052 | Yeşil | - | 37,00 USD |
| AT61-05082 | Amber | - | 37,00 USD |

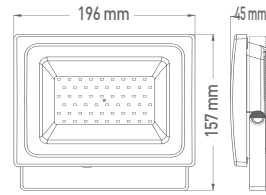

Gerilim : 220 V
Güç : 50 W
Koli Miktarı : 10 Ad

YERLİ ÜRETİM

100 W LED Projektör

RoHS Compliant | CE | 30.000 hr | IP65



| Kod | Renk I. | I. Akısı | Fiyat |
|------------|---------|----------|-----------|
| AT61-19102 | 3000K | 8300 lm | 70,00 USD |
| AT61-19132 | 6500K | 8600 lm | 70,00 USD |

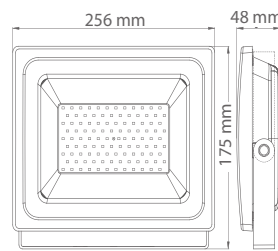

Gerilim : 220 V
Güç : 100 W
Koli Miktarı : 5 Ad

YERLİ ÜRETİM

150 W LED Projektör

RoHS Compliant | CE | 30.000 hr | IP65



| Kod | Renk I. | I. Akısı | Fiyat |
|------------|---------|----------|------------|
| AT61-19402 | 3000K | 13300 lm | 130,00 USD |
| AT61-19432 | 6500K | 13500 lm | 130,00 USD |

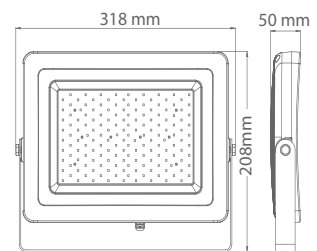

Gerilim : 220 V
Güç : 150 W
Koli Miktarı : 3 Ad

YERLİ ÜRETİM

200 W LED Projektör

RoHS Compliant | CE | 30.000 hr | IP65



| Kod | Renk I. | I. Akısı | Fiyat |
|------------|---------|----------|------------|
| AT61-19602 | 3000K | 17730 lm | 160,00 USD |
| AT61-19632 | 6500K | 18000 lm | 160,00 USD |

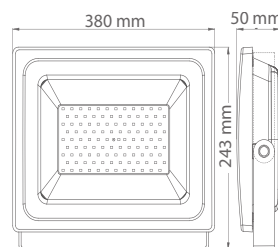

Gerilim : 220 V
Güç : 100 W
Koli Miktarı : 5 Ad

YERLİ ÜRETİM

24 Volt / 50 W SMD LED Projektör

RoHS Compliant | CE | 30.000 hr | IP65



| Kod | Renk I. | I. Akısı | Fiyat |
|------------|---------|----------|-----------|
| AT61-45032 | 6500K | 4500 lm | 75,60 USD |

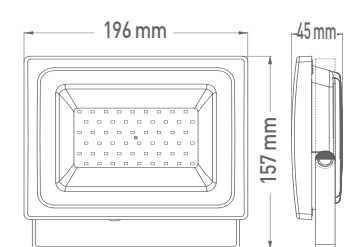

Gerilim : 24 V
Güç : 50 W
Koli Miktarı : 10 Ad

YERLİ ÜRETİM

LED Projektörler

LED Floodlights

70 W LED Projektör

RoHS Compliant | CE | 30.000 hr | IP65



| Kod | Renk I. | I. Akısı | Fiyat |
|------------|---------|----------|-----------|
| AT61-07002 | 3000K | 6025 lm | 65,00 USD |
| AT61-07032 | 6500K | 6300 lm | 65,00 USD |

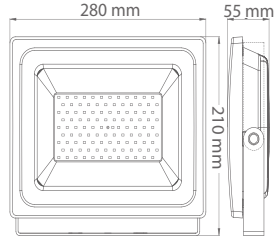

Gerilim : 220 V
Güç : 70 W
Koli Miktarı : 5 Ad



100 W LED Projektör

RoHS Compliant | CE | 30.000 hr | IP65



| Kod | Renk I. | I. Akısı | Fiyat |
|------------|---------|----------|-----------|
| AT61-09102 | 3000K | 8500 lm | 85,00 USD |
| AT61-09132 | 6500K | 9000 lm | 85,00 USD |

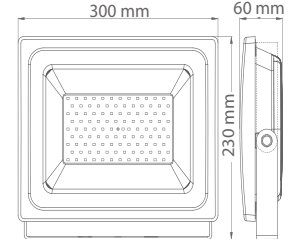

Gerilim : 220 V
Güç : 100 W
Koli Miktarı : 5 Ad



150 W LED Projektör

RoHS Compliant | CE | 30.000 hr | IP65



| Kod | Renk I. | I. Akısı | Fiyat |
|------------|---------|----------|------------|
| AT61-09402 | 3000K | 13300 lm | 155,00 USD |
| AT61-09432 | 6500K | 13500 lm | 155,00 USD |

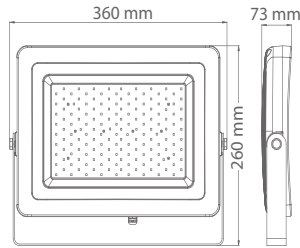

Gerilim : 220 V
Güç : 150 W
Koli Miktarı : 3 Ad



200 W LED Projektör

RoHS Compliant | CE | 30.000 hr | IP65

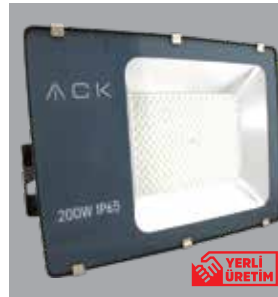

| Kod | Renk I. | I. Akısı | Fiyat |
|------------|---------|----------|------------|
| AT61-09602 | 3000K | 17500 lm | 210,00 USD |
| AT61-09632 | 6500K | 18000 lm | 210,00 USD |

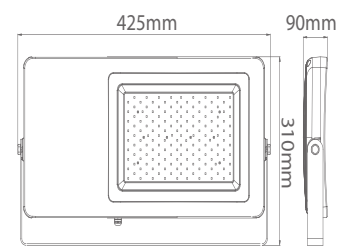

Gerilim : 220 V
Güç : 200 W
Koli Miktarı : 3 Ad



400 W LED Projektör

RoHS Compliant | CE | 30.000 hr | IP65



| Kod | Renk I. | I. Akısı | Fiyat |
|------------|---------|----------|------------|
| AT61-09802 | 3000K | 37000 lm | 390,00 USD |
| AT61-09832 | 6500K | 38000 lm | 390,00 USD |

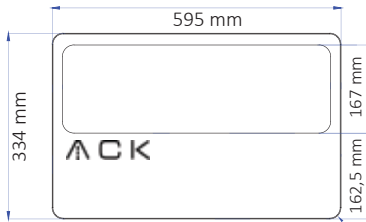

Gerilim : 220 V
Güç : 400 W
Koli Miktarı : 1 Ad



20 W Sensörlü SMD LED Projektör

RoHS Compliant | CE | 30.000 hr | IP65



| Kod | Güç | Fiyat |
|------------|------|-----------|
| AT61-22032 | 20 W | 42,00 USD |

Renk :6500K

Gerilim : 220 V
İzolasyon : IP65
Işık Akısı : 1750 lm
Koli Miktarı : 20 ad



RoHS Compliant | CE | ISO 9001 | 30.000 hr | 160° | IP65

30 W Sensörlü SMD LED Projektör

RoHS Compliant | CE | 30.000 hr | IP65



| Kod | Renk I. | I. Akısı | Fiyat |
|------------|---------|----------|-----------|
| AT61-23032 | 6500K | 2700 lm | 50,00 USD |

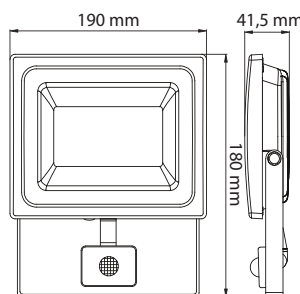

Gerilim : 220 V
Güç : 30 W
Koli Miktarı : 20 Ad



50 W Sensörlü SMD LED Projektör

RoHS Compliant | CE | 30.000 hr | IP65



| Kod | Renk I. | I. Akısı | Fiyat |
|------------|---------|----------|-----------|
| AT61-25032 | 6500K | 4500 lm | 62,00 USD |

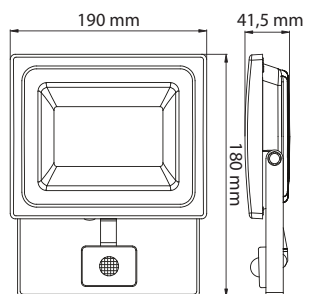

Gerilim : 220 V
Güç : 50 W
Koli Miktarı : 10 Ad



LED Tam Spektrumlu Bitki Yetiştirme Armatürleri

Full Spectrum LED Grow Lights

Tam spektrum, bitki ve hayvanlar için yararlı tüm dalga boylarını kapsayan aydınlatma çeşididir. Güneş ışığının dünyaya ulaşan kısmı zamana, enleme ve atmosferik koşullara göre değişse de, güneş ışığı tam spektrum olarak kabul edilir. ACK tam spektrumlu bitki yetiştirme armatürü, Fotosentezi yönlendirmek için sağlıklı kırmızı / mavi oranına sahip yüksek verimli full spektrum

ışık sağlar. 500-599 nm arasındaki ışık enerjisi, fotomorfojenik tepkileri teşvik eden bitki kanopisine daha derin nüfuz eder. Yüksek renk veren "beyaz" ışık, bitkinize yönelik olası tehditleri hızla tespit etmeye yardımcı olur ve personel için üstün çalışma koşulları ve güvenlik sağlar. Hem çiçeklenme hem de vejetatif üreme için idealdir.

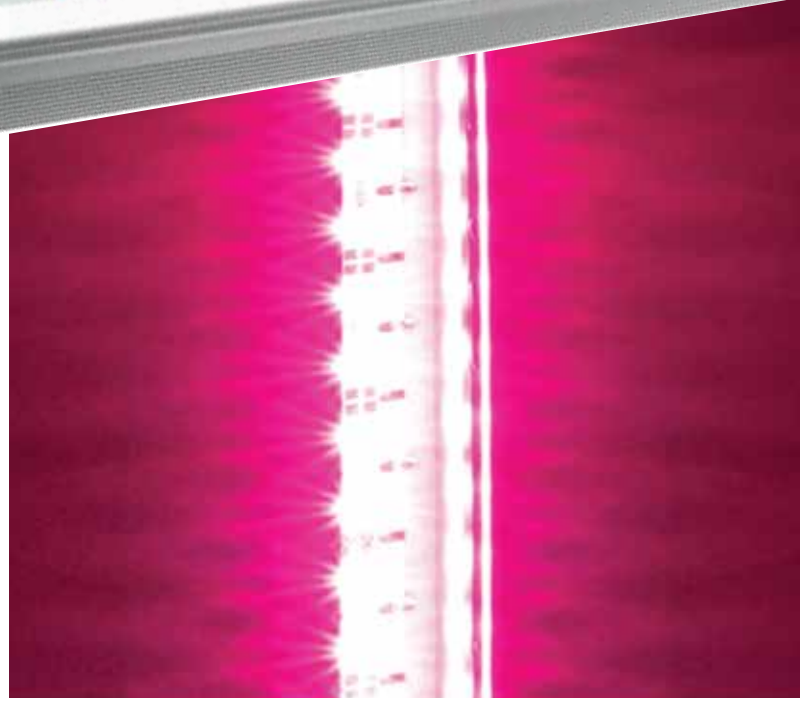
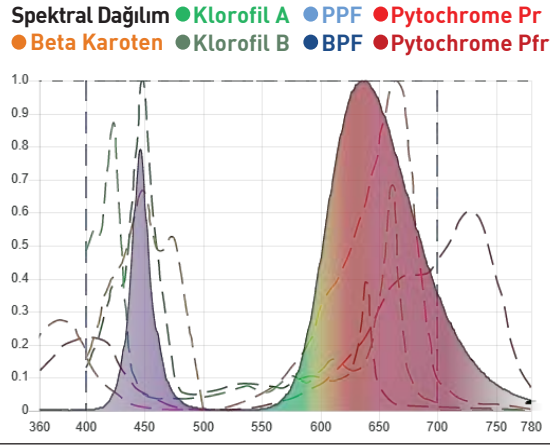
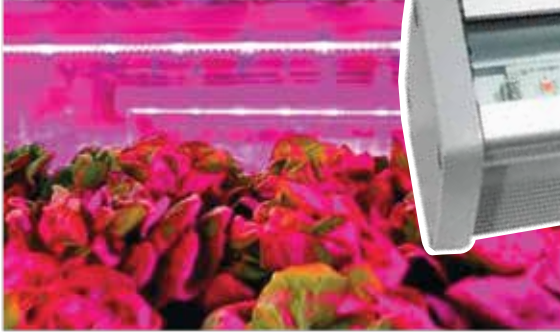

Sistem Giriş Değerleri

| Armatür Başına Hedef Işık Akısı | | | | 18 W: 26 $\mu\text{mol/s}$ | | 36 W: 52 $\mu\text{mol/s}$ | |
|---------------------------------|--------------------|------------|------------------|----------------------------|---------------|----------------------------|----------|
| Renk | Armatür Kodu / Güç | Fiyatı | Işık Akısı Oranı | LED Işık Akısı | LED Parlaklık | LED Voltaj | LED Akım |
| Mor (400-800 nm) | AT21-01800 / 18W | 140,00 USD | 100 % | 25 $\mu\text{mol/s}$ | 352,5 mW | 6,37 V | 150 mA |
| | AT21-03600 / 36W | 240,00 USD | | | | | |

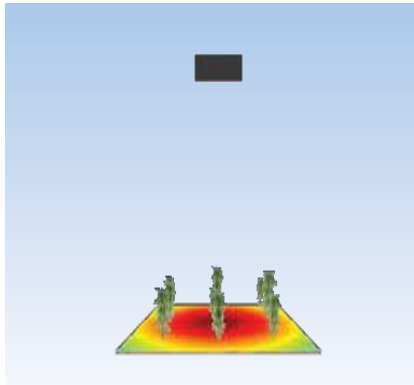

| Sistem Özellikleri | 18W | 36W |
|-------------------------|--------|---------|
| Optik Verimlilik | 90 % | 90 % |
| Elektriksel Verimlilik | 90 % | 90 % |
| Armatür Kurulumu | | |
| Armatür Boyu | 500 mm | 1000 mm |
| Armatür Geniřlięi | 74 mm | 74 mm |



2 Yıl Garanti



Sistem Çıkış Değerleri

| Güç | Işık Akısı Oranı | LED Adedi | Işık Akısı | Fotosentetik Işık Akısı | Işık Akısı Verimi | Alana Düşen Işık Akısı Yoęunluęu (PPFD) |
|-----|------------------|-----------|----------------------|-------------------------|------------------------|---|
| 18W | 100 % | 18 ad. | 26 $\mu\text{mol/s}$ | 23 $\mu\text{mol/s}$ | 1,24 $\mu\text{mol/J}$ | 8,61 $\mu\text{mol/s/m}^2$ |
| 36W | 100 % | 36 ad. | 52 $\mu\text{mol/s}$ | 46 $\mu\text{mol/s}$ | 1,41 $\mu\text{mol/J}$ | 17,22 $\mu\text{mol/s/m}^2$ |



LED Yüksek Tavan Armatürleri

LED High Bay Luminaires

ACK

Alüminyum gövde, PCB ve konveksiyonel soğutma tasarımı sayesinde sıcak ortamlar için mükemmel ısı dağılımı sağlayan tasarım özelliği. Extra Clear Tamperli cam ve PC lensli seçenekleri ile yüksek güvenli ve verimli optik alternatifler. Farklı tavan yüksekliklerine uygun güç, lümen ve açı seçeneği sunabilmektedir. Yüksek sızdırmazlıklı silikon contalı yapısı sayesinde korozif buhar nem ve kimyasal buharlarına karşı maksimum koruma sağlayabilmektedir.

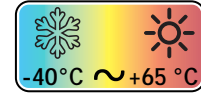
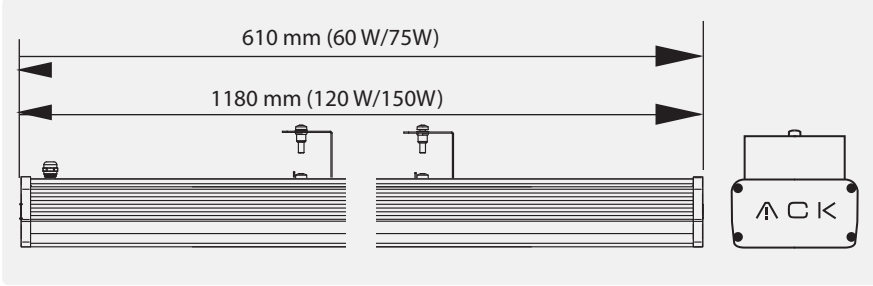

Yüksek sıcaklık koruması ve aşırı yüklenme koruması

Output ripple current (10 hz) <1%

| Teknik Özellikler | 610 mm | 610 mm | 910 mm | 1180 mm | 1180 mm |
|--------------------|--|--------------|--------------|--------------|--------------|
| Güç Tüketimi | 60 W +/- 5% | 75 W +/- 5% | 100 W +/- 5% | 120 W +/- 5% | 150 W +/- 5% |
| Besleme Gerilimi | AC 220-240 V | AC 220-240 V | AC 220-240 V | AC 220-240 V | AC 220-240 V |
| Besleme Akımı | 0,026 A | 0,039 A | 0,434 A | 0,521 A | 0,652 A |
| Frekans | 50-60 Hz | 50-60 Hz | 50-60 Hz | 50-60 Hz | 50-60 Hz |
| Güç Faktörü | 0,98 PF | 0,98 PF | 0,98 PF | 0,98 PF | 0,98 PF |
| Driver Verimliliği | 96% | 96% | 96% | 96% | 96% |
| Lümen/Watt | 133 lm/W | 133 lm/W | 133 lm/W | 133 lm/W | 133 lm/W |
| Aydınlatma Açısı | 60° Standart / 30°, 90° ve Asimetrik Opsiyoneldir. | | | | |
| Led Tipi | 3030 mm | 3030 mm | 3030 mm | 3030 mm | 3030 mm |
| CRI | Ra≥ 80 | Ra≥ 80 | Ra≥ 80 | Ra≥ 80 | Ra≥ 80 |
| Işık Akısı | 8.000 lm | 10.000 lm | 13.300 lm | 16.000 lm | 20.000 lm |
| Çalışma Isısı | -40+65 °C | -40+65 °C | -40+65 °C | -40+65 °C | -40+65 °C |
| Surge Capability | 4 kv | 4 kv | 4 kv | 4 kv | 4 kv |
| Garanti | 2 Yıl | 2 Yıl | 2 Yıl | 2 Yıl | 2 Yıl |
| Led Ömrü | 50.000 Saat | 50.000 Saat | 50.000 Saat | 50.000 Saat | 50.000 Saat |

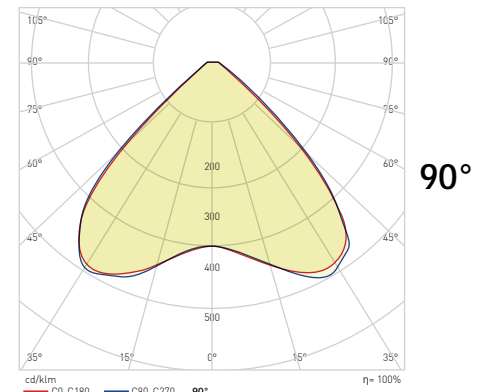
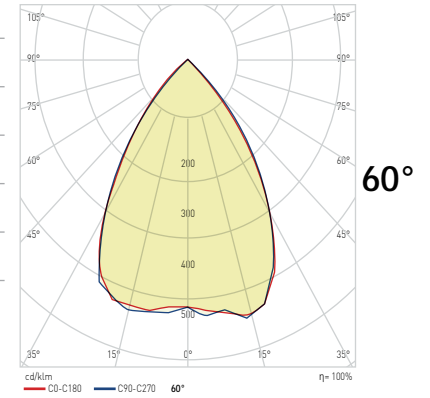
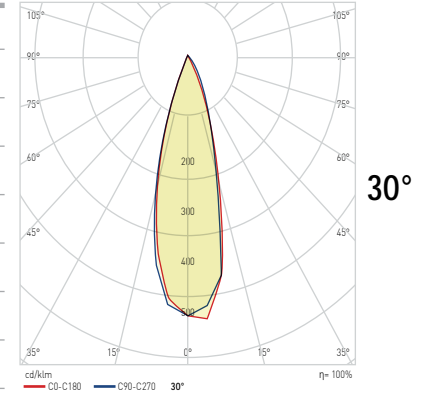

Farklı lens opsiyonlarımız mevcuttur. Lütfen iletişime geçiniz.
Spor salonu uygulamaları için, dereceli montaj aparatı opsiyonu mevcuttur.

OSRAM LED

LUMILEDS

NICHIA

OSRAM Driver Industry Series

PHILIPS Driver

RoHS Compliant

CE

50.000 hr



YERLİ ÜRETİM



| 60 W | Kod | Güç | Uzunluk | Renk Isısı | Işık Akısı | Fiyat |
|------|-------------|------|---------|------------|------------|------------|
| | AT45- 06003 | 60 W | 610 mm | 3000K | 7,700 lm | 150,00 USD |
| | AT45-06013 | 60 W | 610 mm | 4000K | 7,800 lm | 150,00 USD |
| | AT45-06033 | 60 W | 610 mm | 6500K | 8,000 lm | 150,00 USD |

| 75 W | Kod | Güç | Uzunluk | Renk Isısı | Işık Akısı | Fiyat |
|------|------------|------|---------|------------|------------|------------|
| | AT45-07503 | 75 W | 610 mm | 3000K | 9,850 lm | 181,00 USD |
| | AT45-07513 | 75 W | 610 mm | 4000K | 9,900 lm | 181,00 USD |
| | AT45-07533 | 75 W | 610 mm | 6500K | 10,000 lm | 181,00 USD |

| 100W | Kod | Güç | Uzunluk | Renk Isısı | Işık Akısı | Fiyat |
|------|------------|-------|---------|------------|------------|------------|
| | AT45-19103 | 100 W | 910 mm | 3000K | 13,000 lm | 231,00 USD |
| | AT45-19113 | 100 W | 910 mm | 4000K | 13,100 lm | 231,00 USD |
| | AT45-19133 | 100 W | 910 mm | 6500K | 13,300 lm | 231,00 USD |

| 120W | Kod | Güç | Uzunluk | Renk Isısı | Işık Akısı | Fiyat |
|------|------------|-------|---------|------------|------------|------------|
| | AT45-29203 | 120 W | 1180 mm | 3000K | 15,700 lm | 262,00 USD |
| | AT45-29213 | 120 W | 1180 mm | 4000K | 15,800 lm | 262,00 USD |
| | AT45-29233 | 120 W | 1180 mm | 6500K | 16,000 lm | 262,00 USD |

| 150W | Kod | Güç | Uzunluk | Renk Isısı | Işık Akısı | Fiyat |
|------|------------|-------|---------|------------|------------|------------|
| | AT45-29403 | 150 W | 1180 mm | 3000K | 19,700 lm | 267,00 USD |
| | AT45-29413 | 150 W | 1180 mm | 4000K | 19,800 lm | 267,00 USD |
| | AT45-29433 | 150 W | 1180 mm | 6500K | 20,000 lm | 26700 USD |



LED Yüksek Tavan Armatürleri

LED High Bay Luminaires

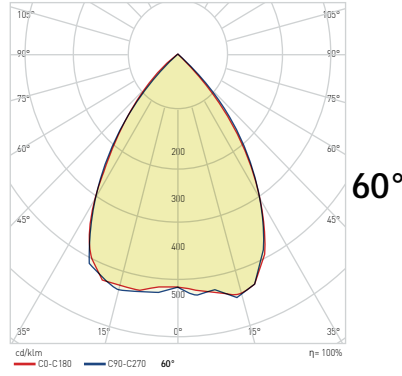
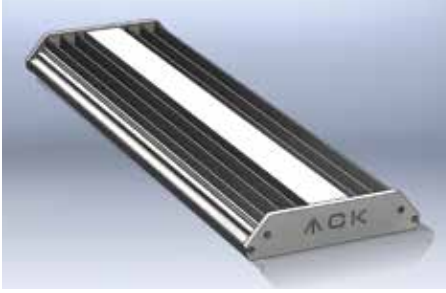

Alüminyum gövde, PCB ve konveksiyonel soğutma tasarımı sayesinde sıcak ortamlar için mükemmel ısı dağılımı sağlayan tasarım özelliği. Extra Clear Tamperli cam ve PC lensli seçenekleri ile yüksek güvenli ve verimli optik alternatifler. Farklı tavan yüksekliklerine uygun güç, lümen ve açı seçeneği sunabilmektedir. Yüksek sızdırmazlıklı silikon contalı yapısı sayesinde korozif buhar nem ve kimyasal buharlarına karşı maksimum koruma sağlayabilmektedir.

Teknik Özellikler

| | | |
|-------------------------|---------------------------------|---|
| Besleme Gerilimi | AC 220-240 V | Driver: Endüstriyel, DALİ, Acil durum kiti. |
| Frekans | 50-60 Hz | |
| Güç Faktörü Düzelt. | 0,95 Pf | |
| Aydınlatma Açısı (Lens) | 30°, 60°, 90° Asimetrik Lenssiz | Askı Seti: Sarkıt, Dereceli |
| Driver Verimliliği | %93 | Opsiyonel: |
| LED Tipi | 3030 | Endüstriyel (-40°C/ +65°C) |
| Surge Capability | 2 KV | 4 KV Surge |
| CRI | Ra≥80 | Ürün Tipleri: |
| Çalışma Isısı | -20/+50 °C | Spor Salonu, Tünel, Steril Ortam |
| IP | IP 65 | |
| Garanti | 2 Yıl | |

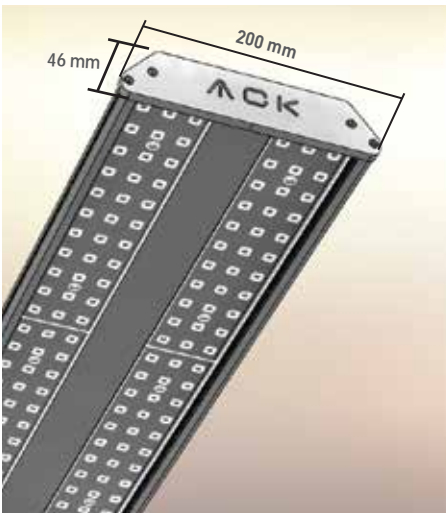
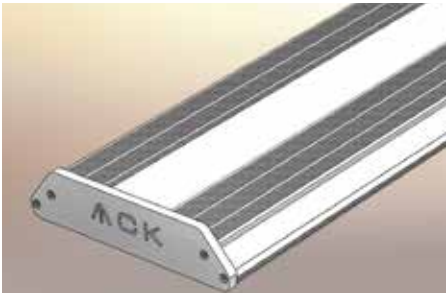

| 50 W | Kod | Uzunluk | Renk Isısı | Işık Akısı | Akım | Fiyat |
|------|------------|---------|------------|------------|--------|-----------|
| | AT46-05003 | 310 mm | 3000K | 6450 lm | 0,22 A | 80,00 USD |
| | AT46-05013 | 310 mm | 4000K | 6550 lm | 0,22 A | 80,00 USD |
| | AT46-05033 | 310 mm | 6500K | 6660 lm | 0,22 A | 80,00 USD |

| 100W | Kod | Uzunluk | Renk Isısı | Işık Akısı | Akım | Fiyat |
|------|------------|---------|------------|------------|--------|------------|
| | AT46-19103 | 600 mm | 3000K | 12900 lm | 0,43 A | 141,00 USD |
| | AT46-19113 | 600 mm | 4000K | 13100 lm | 0,43 A | 141,00 USD |
| | AT46-19133 | 600 mm | 6500K | 13330 lm | 0,43 A | 141,00 USD |

| 150W | Kod | Uzunluk | Renk Isısı | Işık Akısı | Akım | Fiyat |
|------|------------|---------|------------|------------|--------|------------|
| | AT46-29403 | 890 mm | 3000K | 19350 lm | 0,65 A | 192,00 USD |
| | AT46-29413 | 890 mm | 4000K | 19650 lm | 0,65 A | 192,00 USD |
| | AT46-29433 | 890 mm | 6500K | 20000 lm | 0,65 A | 192,00 USD |

| 200W | Kod | Uzunluk | Renk Isısı | Işık Akısı | Akım | Fiyat |
|------|------------|---------|------------|------------|--------|------------|
| | AT46-49403 | 1180 mm | 3000K | 25800 lm | 0,87 A | 244,00 USD |
| | AT46-49413 | 1180 mm | 4000K | 26200 lm | 0,87 A | 244,00 USD |
| | AT46-49433 | 1180 mm | 6500K | 26660 lm | 0,87 A | 244,00 USD |

Atölye Tipi LED Yüksek Tavan Armatürleri

LED High Bay Luminaires

ACK

100W Atölye Tipi LED Yüksek Tavan Armatürü

RoHS Compliant

CE

ISO 9001

30.000 hr

IP54

70°



Temiz bir LED ışığını garanti eden, akışkan dinamiğine uygun, basit, kolay değiştirilebilir, kendi kendini temizleyen tasarım. Toz tutmayan konvansiyonel tasarım ile daha az ısı radyasyonu. Siyah eloksal işlemlili yüzey ısıyı daha iyi soğurur.

Teknik Özellikler

| | |
|---------------------|--------------|
| Güç Tüketimi | 100 W +/- 5% |
| Besleme Gerilimi | AC 180-240 V |
| Besleme Akımı | 434 mA |
| Frekans | 50-60 Hz |
| Güç Faktörü Düzelt. | 0,95 Pf |
| Lümen/Watt | 100 lm/W |
| Aydınlatma Açısı | 70° |
| CRI | Ra≥70 |
| Işık Akısı | 10,000 lm |
| Çalışma Isısı | -20/+45 °C |
| IP | IP 54 |
| Garanti | 2 Yıl |

| Kod | Güç | Ayd. Açısı | Renk | Fiyat |
|------------|-------|------------|-------|------------|
| AT44-09130 | 100 W | 70° | 6500K | 163,00 USD |

Koli Miktarı: 1 ad.

LED Spotlar

LED Spots

5W COB LED Spot Armatür



| Kod | Kasa . | Renk | Fiyat |
|------------|--------|-------|----------|
| AD01-00500 | Beyaz | 3000K | 4,35 USD |
| AD01-00510 | Beyaz | 4000K | 4,35 USD |
| AD01-00530 | Beyaz | 6500K | 4,35 USD |

Gerilim : 220 V
Güç : 5 W
Koli Miktarı: 100 ad

RoHS Compliant | CE | ISO 9001 | 30.000 hr | 65mm | 50° | IP20

2W Sıva Altı Renkli LED Spot Armatürler



| Kod | Renk | Fiyat |
|------------|-------|----------|
| AH06-00850 | Yeşil | 5,50 USD |

Gerilim : 220 V
Kesim Ölçüsü : 35 mm
Koli Miktarı : 100 ad

RoHS Compliant | CE | ISO 9001 | 30.000 hr | 35mm | 160° | IP20

13W COB LED Dekoratif Spot Armatür



| Kod | Fiyat |
|----------|----------|
| 5006-005 | 8,00 USD |

Gerilim : 220 V
Güç : 13 W
Işık Akısı : 1100 lm
Kesim Ölçüsü : 80 mm
Aydınlatma Açısı : 160°
Koli Miktarı : 20 ad

Renk: 6500K

RoHS Compliant | CE | ISO 9001 | 30.000 hr | 80mm | 160° | IP20

Prizli Tezgah Altı Armatürler

Under-Counter LED Lighting Fixture

2,5W LED'li Prizli, Tezgah Altı Armatür

IP20

225 lm



YERLİ ÜRETİM

Gövde: Saten

Kod Renk Fiyat

AH11-00204 3000K 26,40 USD

AH11-00234 6500K 26,40 USD

Boyut: 122 mm x 180 mm x 65 mm

Gerilim: 220 V

Gövde: 304 Paslanmaz Çelik
Koli M.:48 Ad.

LED'li, çift prizli, açma kapama düğmeli.

RoHS Compliant | CE | 30.000 hr | IP20

2,5W LED'li Prizli, Tezgah Altı Armatür

IP20

225 lm



YERLİ ÜRETİM

Gövde: Siyah

Kod Renk Fiyat

AH11-00201 3000K 24,75 USD

AH11-00231 6500K 24,75 USD

Boyut: 122 mm x 180 mm x 65 mm

Gerilim: 220 V

Gövde: DKP Çelik +
Elektrostatik Siyah Toz Boya
Koli M.:48 Ad.

LED'li, çift prizli, açma kapama düğmeli.

RoHS Compliant | CE | 30.000 hr | IP20

2,5W LED'li Prizli, Tezgah Altı Armatür

IP20

225 lm



YERLİ ÜRETİM

Gövde: Beyaz

Kod Renk Fiyat

AH11-00200 3000K 24,75 USD

AH11-00230 6500K 24,75 USD

Boyut: 122 mm x 180 mm x 65 mm

Gerilim: 220 V

Gövde: DKP Çelik +
Elektrostatik Beyaz Toz Boya
Koli M.:48 Ad.

LED'li, çift prizli, açma kapama düğmeli.

RoHS Compliant | CE | 30.000 hr | IP20

Sensörler

Sensors

180° Duvar Tipi Lüks Hareket Sensörü



Kod Fiyat

AY31-01030 11,55 USD

Gerilim : 220 V

Algılama Açısı : 180°

Koli Miktarı : 50 ad

RoHS Compliant | CE | 180° | IP20

360° Tavan Tipi Lüks Hareket Sensörü



Kod Fiyat

AY31-01010 11,55 USD

Gerilim : 220 V

Algılama Açısı : 360°

Koli Miktarı : 50 ad

RoHS Compliant | CE | 360° | IP20

Mikrodalga Radar Sensör



YENİ

Zaman Ayarlı

Kod Fiyat

AY31-02020 14,10 USD

Gerilim : 220 V

Algi. Açısı : 360°

Koli Mikt. : 100 ad

RoHS Compliant | CE | 360° | IP20

360° S/A Tavan T.Hareket Sensörü



Delik Çapı: 65 mm

Kod Fiyat

AY31-01040 10,50 USD

Gerilim : 220 V

Algi. Açısı : 360°

Koli Mikt. : 100 ad

RoHS Compliant | CE | 360° | IP20

Mini Sensör



Kod Fiyat

AY31-01050 10,50 USD

Gerilim : 220 V

Algi. Açısı : 100°

Koli Mikt. : 100 ad

RoHS Compliant | CE | 100° | IP20



Çeşitli boy ve tipte modellere sahip, değişik montaj seçenekleriyle farklı projeler için işlevsel çözümler sunar. Çeşitli boyutlarda alüminyum profil gövde. Alternatif renk ısıları, uzunluk ve gövde rengi ile sınırsız model seçeneklerini sipariş üzerine sunabiliriz. DALI ve acil durum kiti özelliği isteğe bağlı olarak üretilebilir.

Teknik Özellikler (Osram Driver)

| | | | |
|------------------------|---------------|----------------|----------------|
| Güç Tüketimi | 22 W - 610 mm | 36 W / 1010 mm | 44 W / 1210 mm |
| Besleme Gerilimi | AC 220-240 V | AC 220-240 V | AC 220-240 V |
| Besleme Akımı | 0,10 A | 0,16 A | 0,20 A |
| Frekans | 50-60 Hz | 50-60 Hz | 50-60 Hz |
| Güç Faktörü Düzeltmesi | 0,95 PF | 0,95 PF | 0,95 PF |
| Driver Verimliliği | 90% | 90% | 90% |
| Lümen/Watt | 100 lm/W | 100 lm/W | 100 lm/W |
| Led Tipi | 2835-3030 mm | 2835-3030 mm | 2835-3030 mm |
| CRI | Ra≥80 | Ra≥80 | Ra≥80 |
| Işık Akısı | 2,200 lm | 3,600 lm | 4,400 lm |
| Çalışma Isısı | -20/+45 °C | -20/+45 °C | -20/+45 °C |
| IP | IP20 | IP20 | IP20 |
| Garanti | 2 Yıl | 2 Yıl | 2 Yıl |
| Led Ömrü | 30.000 Saat | 30.000 Saat | 30.000 Saat |

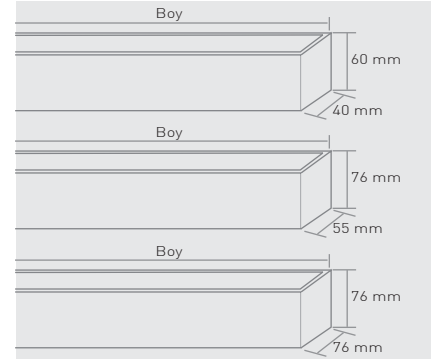
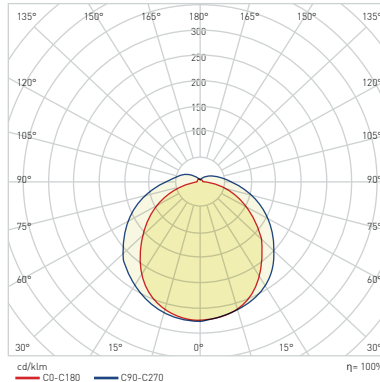

Difüzör ve profil yüzeyinde koruyucu folyo ile sevk edilir.

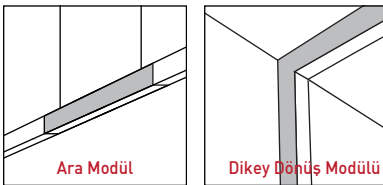
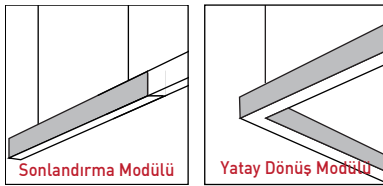
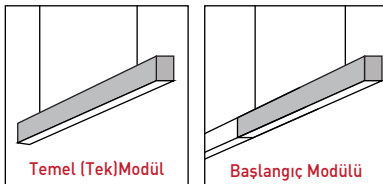

Başlangıç Modülü

Yatay Dönüş Modülü

90°

Standart Boylar: 60-90-120 cm'dir. Özel ölçüler 5 cm'nin katları şeklindedir. Özel şekilli veya eklenebilir ürünler için bizimle iletişime geçiniz.

90° Dikey Dönüş Modülü

Ara Modül

Sonlandırma Modülü

Özel Formlar



LED Linear sistemin modüler yapısı sayesinde bunlar ve bunlara benzer pek çok özel şekil yapmak direkt/endirekt aydınlatma yapmak, tavan ve duvarda kullanmak, farklı şekillerde tavana monte etmek mümkündür.

LED Linear Armatürler

LED Linear Luminaires

40 mm X 60 mm

PHILIPS Driver OSRAM Driver Industry Series OSRAM LED



| Kod | Güç | Renk I. | Işık Akısı | Akım | Boy (B) | Gövde | Fiyat |
|------------|------|---------|------------|--------|---------|-------|-----------|
| AL01-22601 | 22 W | 3000K | 2100 lm | 0,10 A | 610 mm | Siyah | 40,00 USD |
| AL01-22611 | 22 W | 4000K | 2150 lm | 0,10 A | 610 mm | Siyah | 40,00 USD |
| AL01-22631 | 22 W | 6500K | 2200 lm | 0,10 A | 610 mm | Siyah | 40,00 USD |
| AL01-22901 | 36 W | 3000K | 3200 lm | 0,16 A | 1010 mm | Siyah | 52,00 USD |
| AL01-22911 | 36 W | 4000K | 3250 lm | 0,16 A | 1010 mm | Siyah | 52,00 USD |
| AL01-22931 | 36 W | 6500K | 3300 lm | 0,16 A | 1010 mm | Siyah | 52,00 USD |
| AL01-22201 | 44 W | 3000K | 4300 lm | 0,20 A | 1210 mm | Siyah | 62,00 USD |
| AL01-22211 | 44 W | 4000K | 4350 lm | 0,20 A | 1210 mm | Siyah | 62,00 USD |
| AL01-22231 | 44 W | 6500K | 4400 lm | 0,20 A | 1210 mm | Siyah | 62,00 USD |

55 mm X 76 mm

PHILIPS Driver OSRAM Driver Industry Series OSRAM LED



| Kod | Güç | Renk I. | Işık Akısı | Akım | Boy (B) | Gövde | Fiyat |
|------------|------|---------|------------|--------|---------|-------|-----------|
| AL01-02601 | 22 W | 3000K | 2100 lm | 0,10 A | 610 mm | Siyah | 46,00 USD |
| AL01-02611 | 22 W | 4000K | 2150 lm | 0,10 A | 610 mm | Siyah | 46,00 USD |
| AL01-02631 | 22 W | 6500K | 2200 lm | 0,10 A | 610 mm | Siyah | 46,00 USD |
| AL01-02901 | 36 W | 3000K | 3200 lm | 0,16 A | 1010 mm | Siyah | 63,00 USD |
| AL01-02911 | 36 W | 4000K | 3250 lm | 0,16 A | 1010 mm | Siyah | 63,00 USD |
| AL01-02931 | 36 W | 6500K | 3300 lm | 0,16 A | 1010 mm | Siyah | 63,00 USD |
| AL01-02201 | 44 W | 3000K | 4300 lm | 0,20 A | 1210 mm | Siyah | 72,00 USD |
| AL01-02211 | 44 W | 4000K | 4350 lm | 0,20 A | 1210 mm | Siyah | 72,00 USD |
| AL01-02231 | 44 W | 6500K | 4400 lm | 0,20 A | 1210 mm | Siyah | 72,00 USD |

76 mm X 76 mm

PHILIPS Driver OSRAM Driver Industry Series OSRAM LED



| Kod | Güç | Renk I. | Işık Akısı | Akım | Boy (B) | Gövde | Fiyat |
|------------|------|---------|------------|--------|---------|-------|-----------|
| AL01-12601 | 22 W | 3000K | 2100 lm | 0,10 A | 610 mm | Siyah | 54,00 USD |
| AL01-12611 | 22 W | 4000K | 2150 lm | 0,10 A | 610 mm | Siyah | 54,00 USD |
| AL01-12631 | 22 W | 6500K | 2200 lm | 0,10 A | 610 mm | Siyah | 54,00 USD |
| AL01-12901 | 36 W | 3000K | 3200 lm | 0,16 A | 1010 mm | Siyah | 70,00 USD |
| AL01-12911 | 36 W | 4000K | 3250 lm | 0,16 A | 1010 mm | Siyah | 70,00 USD |
| AL01-12931 | 36 W | 6500K | 3300 lm | 0,16 A | 1010 mm | Siyah | 70,00 USD |
| AL01-12201 | 44 W | 3000K | 4300 lm | 0,20 A | 1210 mm | Siyah | 88,00 USD |
| AL01-12211 | 44 W | 4000K | 4350 lm | 0,20 A | 1210 mm | Siyah | 88,00 USD |
| AL01-12231 | 44 W | 6500K | 4400 lm | 0,20 A | 1210 mm | Siyah | 88,00 USD |



40 mm X 60 mm

OSRAM LED

| Kod (Siyah) | Güç | Renk I. | Işık Akısı | Akım | Boy (B) | Gövde | Fiyat |
|-------------|------|---------|------------|--------|---------|-------|-----------|
| AL01-20601 | 18 W | 3000K | 1700 lm | 0,08 A | 610 mm | Siyah | 32,00 USD |
| AL01-20611 | 18 W | 4000K | 1750 lm | 0,08 A | 610 mm | Siyah | 32,00 USD |
| AL01-20631 | 18 W | 6500K | 1800 lm | 0,08 A | 610 mm | Siyah | 32,00 USD |
| AL01-20901 | 30 W | 3000K | 2900 lm | 0,13 A | 1010 mm | Siyah | 44,00 USD |
| AL01-20911 | 30 W | 4000K | 2950 lm | 0,13 A | 1010 mm | Siyah | 44,00 USD |
| AL01-20931 | 30 W | 6500K | 3000 lm | 0,13 A | 1010 mm | Siyah | 44,00 USD |
| AL01-21201 | 36 W | 3000K | 3500 lm | 0,16 A | 1210 mm | Siyah | 54,00 USD |
| AL01-21211 | 36 W | 4000K | 3550 lm | 0,16 A | 1210 mm | Siyah | 54,00 USD |
| AL01-21231 | 36 W | 6500K | 3600 lm | 0,16 A | 1210 mm | Siyah | 54,00 USD |

55 mm X 76 mm

OSRAM LED

| Kod (Siyah) | Güç | Renk I. | Işık Akısı | Akım | Boy (B) | Gövde | Fiyat |
|-------------|------|---------|------------|--------|---------|-------|-----------|
| AL01-00601 | 18 W | 3000K | 1700 lm | 0,08 A | 610 mm | Siyah | 36,00 USD |
| AL01-00611 | 18 W | 4000K | 1750 lm | 0,08 A | 610 mm | Siyah | 36,00 USD |
| AL01-00631 | 18 W | 6500K | 1800 lm | 0,08 A | 610 mm | Siyah | 36,00 USD |
| AL01-00901 | 30 W | 3000K | 2900 lm | 0,13 A | 1010 mm | Siyah | 52,00 USD |
| AL01-00911 | 30 W | 4000K | 2950 lm | 0,13 A | 1010 mm | Siyah | 52,00 USD |
| AL01-00931 | 30 W | 6500K | 3000 lm | 0,13 A | 1010 mm | Siyah | 52,00 USD |
| AL01-01201 | 36 W | 3000K | 3500 lm | 0,16 A | 1210 mm | Siyah | 60,00 USD |
| AL01-01211 | 36 W | 4000K | 3550 lm | 0,16 A | 1210 mm | Siyah | 60,00 USD |
| AL01-01231 | 36 W | 6500K | 3600 lm | 0,16 A | 1210 mm | Siyah | 60,00 USD |

76 mm X 76 mm

OSRAM LED

| Kod (Siyah) | Güç | Renk I. | Işık Akısı | Akım | Boy (B) | Gövde | Fiyat |
|-------------|------|---------|------------|--------|---------|-------|-----------|
| AL01-10601 | 18 W | 3000K | 1700 lm | 0,08 A | 610 mm | Siyah | 46,00 USD |
| AL01-10611 | 18 W | 4000K | 1750 lm | 0,08 A | 610 mm | Siyah | 46,00 USD |
| AL01-10631 | 18 W | 6500K | 1800 lm | 0,08 A | 610 mm | Siyah | 46,00 USD |
| AL01-10901 | 30 W | 3000K | 2900 lm | 0,13 A | 1010 mm | Siyah | 66,00 USD |
| AL01-10911 | 30 W | 4000K | 2950 lm | 0,13 A | 1010 mm | Siyah | 66,00 USD |
| AL01-10931 | 30 W | 6500K | 3000 lm | 0,13 A | 1010 mm | Siyah | 66,00 USD |
| AL01-11201 | 36 W | 3000K | 3500 lm | 0,16 A | 1210 mm | Siyah | 85,00 USD |
| AL01-11211 | 36 W | 4000K | 3550 lm | 0,16 A | 1210 mm | Siyah | 85,00 USD |
| AL01-11231 | 36 W | 6500K | 3600 lm | 0,16 A | 1210 mm | Siyah | 85,00 USD |

Doğal ahşap kaplamalı ve özel ürün talepleriniz için lütfen fiyat alın.



Tavan Montaj
Aparatları



| Kod | Adı | Fiyat |
|------------|---|----------|
| AL01-90001 | LED Linear Arm. için Askı Aparatı (150cm) | 4,50 USD |
| AL01-90002 | LED Linear Armatürler için Rozans | 4,50 USD |

LED Kanopi Armatürleri

LED Canopy Luminaires

Gövde ve driver muhafaza kutusu yüksek ısı iletme özelliğine sahip alüminyum enjeksiyon malzemeden. Yüzey işlemleri ve kromatlama yapılarak harici ortama dayanıklı elektrostatik toz boya ile boyanmıştır. Sızdırmazlık contaları silikon olup yüksek sıcaklıklara dayanabilecek özelliktedir. 4mm temperli kumlu cam kamaşmayı minimize ederek soft bir aydınlık ortamı sağlayabilmektedir. Farklı kanopi yüksekliklerine uygun özel lens seçenekleri uyarlanabilir. Opsiyonel olarak harici hareket sensörü ve gece belli saatlerden sonra otomatik dim özelliği ile max enerji tasarrufu yapılabilmektedir.

Teknik Özellikler

| | | | |
|------------------------|--------------|--------------|--------------|
| Güç Tüketimi | 60 W +/- 5% | 75 W +/- 5% | 90 W +/- 5% |
| Besleme Gerilimi | AC 220-240 V | AC 220-240 V | AC 220-240 V |
| Besleme Akımı | 0,260 A | 0,326 A | 0,391 A |
| Frekans | 50-60 Hz | 50-60 Hz | 50-60 Hz |
| Güç Faktörü Düzeltmesi | 0,98 Pf | 0,98 Pf | 0,98 Pf |
| Driver Verimliliği | 96 % | 96 % | 96 % |
| Lümen/Watt | 115 lm/W | 115 lm/W | 115 lm/W |
| Aydınlatma Açısı | 90° | 90° | 90° |
| Led Tipi | 3030 | 3030 | 3030 |
| CRI | Ra≥70-80 | Ra≥70-80 | Ra≥70-80 |
| Işık Akısı | 6,100 lm | 8,250 lm | 9,800 lm |
| Çalışma Isısı | -40/+65 °C | -40/+65 °C | -40/+65 °C |
| Garanti | 2 Yıl | 2 Yıl | 2 Yıl |
| Led Ömrü | 50.000 Saat | 50.000 Saat | 50.000 Saat |

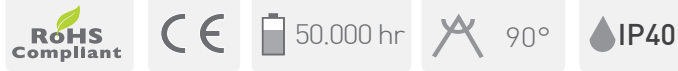
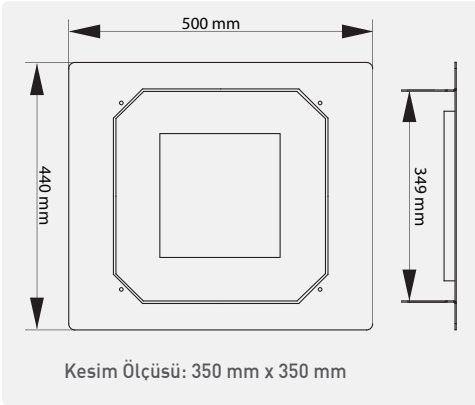
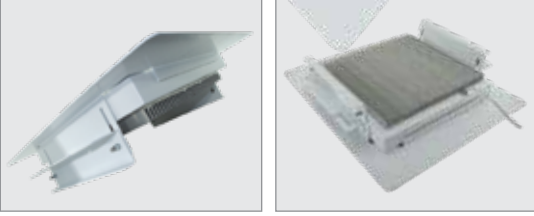
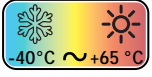

| Kod | Güç | Renk Isısı | Işık Akısı | Fiyat |
|------------|------|------------|------------|------------|
| AT38-06000 | 60 W | 3000K | 6,600 lm | 220,00 USD |
| AT38-06010 | 60 W | 4000K | 6,700 lm | 220,00 USD |
| AT38-06030 | 60 W | 6500K | 6,900 lm | 220,00 USD |
| AT38-07500 | 75 W | 3000K | 8,250 lm | 242,00 USD |
| AT38-07510 | 75 W | 4000K | 8,350 lm | 242,00 USD |
| AT38-07530 | 75 W | 6500K | 8,625 lm | 242,00 USD |
| AT38-09000 | 90 W | 3000K | 9,800 lm | 248,00 USD |
| AT38-09010 | 90 W | 4000K | 10,000 lm | 248,00 USD |
| AT38-09030 | 90 W | 6500K | 10,350 lm | 248,00 USD |

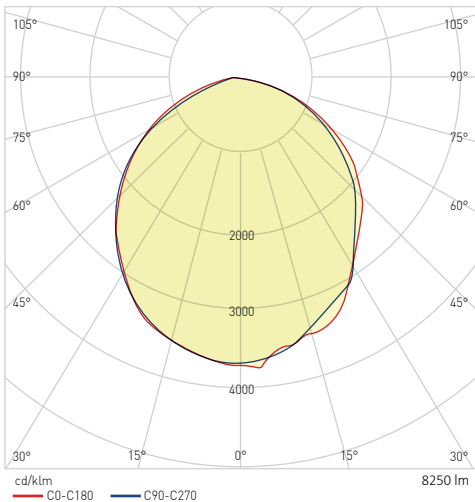



Gövde PC co-ekstrüzyon olup, kapaklar ve klipsler de PC malzemeden üretilmiştir. PCB alüminyum malzeme, ledler 2835 kılıf olup, homojen ışık dağılımına sahiptir. Difüzör yüksek ışık geçirgenliğine sahip olup standart opal renkli -isteğe bağlı olarak yüksek adetlerde- şeffaf üretilebilir. Standart 30 cm kablo çıkışlı olup, rakor IP 65 sızdırmazlığa sahiptir. 610 mm - 1210 mm uzunlukta 3000-4000-6500K olarak üretilebilir. Opsiyonel olarak Dali ve acil kit uygulaması yapılabilir.

Teknik Özellikler

| | | |
|------------------------|--------------|--------------|
| Güç Tüketimi | 18 W +/- 5% | 36 W +/- 5% |
| Besleme Gerilimi | AC 220-240 V | AC 220-240 V |
| Besleme Akımı | 0,09 A | 0,18 A |
| Frekans | 50-60 Hz | 50-60 Hz |
| Güç Faktörü Düzeltmesi | 0,95 Pf | 0,98 Pf |
| Driver Verimliliği | 85 % | 90 % |
| Lümen/Watt | 94 lm/W | 94 lm/W |
| Aydınlatma Açısı | 120 ° | 120 ° |
| Led Tipi | 2835 mm | 2835 mm |
| CRI | Ra≥70 | Ra≥70 |
| Işık Akısı | 1.715 lm | 3.550 lm |
| Çalışma Isısı | -20/+45 °C | -20/+45 °C |
| IP | IP 65 | IP 65 |
| Garanti | 2 Yıl | 2 Yıl |
| Led Ömrü | 30.000 Saat | 30.000 Saat |



Ürünümüz opsiyonel montaj seti ile sarkıt olarak da monte edilebilmektedir.

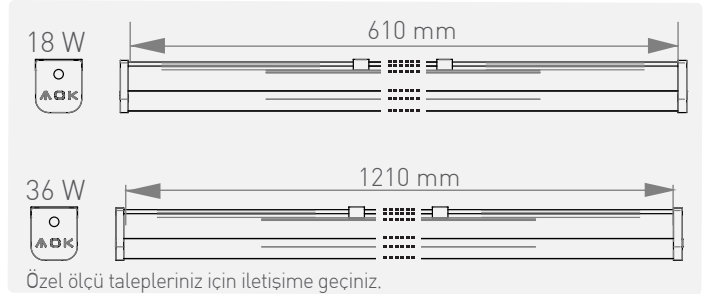

18 W



OSRAM LED A C K Driver

| Kod | Renk Isısı | Boy | Işık Akısı | Fiyat |
|---------------|--------------|--------|------------|------------------|
| AT03-00600 | 3000K | 610 mm | 1550 lm | 22,00 USD |
| AT03-00610 | 4000K | 610 mm | 1650 lm | 22,00 USD |
| AT03-00630 | 6500K | 610 mm | 1715 lm | 22,00 USD |
| AT03-106..... | Kitli | 610 mm | | 37,00 USD |

Koli Miktarı: 24 Ad.

36 W



OSRAM LED A C K Driver

| Kod | Renk Isısı | Boy | Işık Akısı | Fiyat |
|---------------|--------------|---------|------------|------------------|
| AT03-01200 | 3000K | 1210 mm | 3500 lm | 35,00 USD |
| AT03-01210 | 4000K | 1210 mm | 3520 lm | 35,00 USD |
| AT03-01230 | 6500K | 1210 mm | 3550 lm | 35,00 USD |
| AT03-112..... | Kitli | 1210 mm | | 50,00 USD |

Koli Miktarı: 12 Ad.

18 W



OSRAM LED OSRAM Driver

| Kod | Renk Isısı | Boy | Işık Akısı | Fiyat |
|---------------|--------------|--------|------------|------------------|
| AT03-10600 | 3000K | 610 mm | 1550 lm | 25,40 USD |
| AT03-10610 | 4000K | 610 mm | 1650 lm | 25,40 USD |
| AT03-10630 | 6500K | 610 mm | 1715 lm | 25,40 USD |
| AT03-206..... | Kitli | 610 mm | | 41,00 USD |

Koli Miktarı: 24 Ad.

36 W



OSRAM LED OSRAM Driver

| Kod | Renk Isısı | Boy | Işık Akısı | Fiyat |
|---------------|--------------|---------|------------|------------------|
| AT03-11200 | 3000K | 1210 mm | 3500 lm | 43,00 USD |
| AT03-11210 | 4000K | 1210 mm | 3520 lm | 43,00 USD |
| AT03-11230 | 6500K | 1210 mm | 3550 lm | 43,00 USD |
| AT03-212..... | Kitli | 1210 mm | | 57,00 USD |

Koli Miktarı: 12 Ad.

LED Bant Armatürler

LED Luminaires

Merkür LED Bant Armatürler

RoHS Compliant | CE | 30.000 hr | IP20

4 W

| Kod | Renk | Işık Akısı | Fiyat |
|------------|--------|------------|----------|
| AN10-00400 | 3000 K | 360 lm | 8,50 USD |
| AN10-00430 | 6500 K | 380 lm | 8,50 USD |

Uzunluk: 313 mm

Gerilim : 220 V
Güç : 4 W
Koli Miktarı : 30 ad

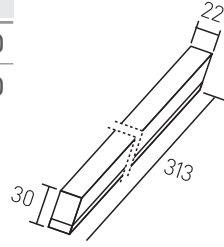

7,5 W

| Kod | Renk | Işık Akısı | Fiyat |
|------------|--------|------------|-----------|
| AN10-00700 | 3000 K | 630 lm | 10,80 USD |
| AN10-00730 | 6500 K | 675 lm | 10,80 USD |

Uzunluk: 543 mm

Gerilim : 220 V
Güç : 7,5 W
Koli Miktarı : 30 ad

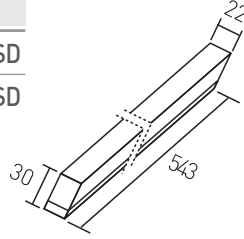

11 W

| Kod | Renk | Işık Akısı | Fiyat |
|------------|--------|------------|-----------|
| AN10-01100 | 3000 K | 950 lm | 13,50 USD |
| AN10-01130 | 6500 K | 1000 lm | 13,50 USD |

Uzunluk: 873 mm

Gerilim : 220 V
Güç : 11 W
Koli Miktarı : 30 ad

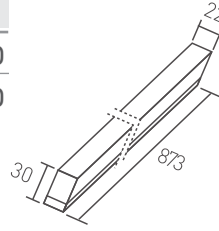

14 W

| Kod | Renk | Işık Akısı | Fiyat |
|------------|--------|------------|-----------|
| AN10-01400 | 3000 K | 1200 lm | 15,50 USD |
| AN10-01430 | 6500 K | 1300 lm | 15,50 USD |

Uzunluk: 1173 mm

Gerilim : 220 V
Güç : 14 W
Koli Miktarı : 30 ad

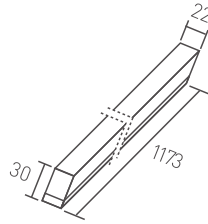

14W Merkür Sensörlü LED Bant Armatür

RoHS Compliant | CE | IP20

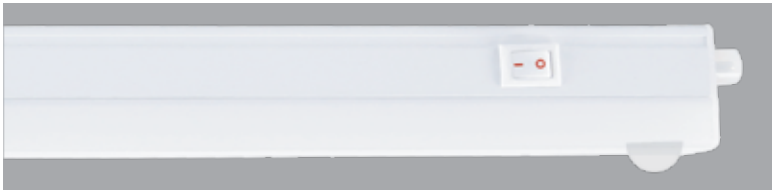

Kod Renk Fiyat

AN10-21430 6500 K 23,40 USD

Gerilim : 220 V
Güç : 14 W
Işık Akısı : 1360 lm
Koli Miktarı : 30 ad

Uzunluk: 1173 mm

Venus LED Bant Armatür

RoHS Compliant | CE | IP20

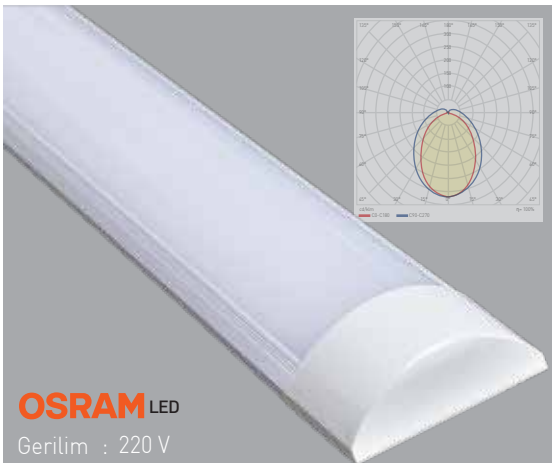

Teknik Özellikler

| | |
|------------------|--------------|
| Besleme Gerilimi | AC 220-240 V |
| Frekans | 50-60 Hz |
| Lümen/Watt | 80 lm/W |
| Aydınlatma Açısı | 120 ° |
| Led Tipi | 2835 mm |
| CRI | Ra≥80 |
| Çalışma Isısı | -20/+45 °C |
| IP | IP 20 |
| Garanti | 2 Yıl |
| Led Ömrü | 30.000 Saat |



18 W

Kod Renk Fiyat

AN18-00603 3000 K 11,00 USD

AN18-00633 6500 K 11,00 USD

Uzunluk: 605 mm Koli: 20 Ad.
Işık Akısı: 1320 lm

36 W

Kod Renk Fiyat

AN18-01203 3000 K 16,50 USD

AN18-01233 6500 K 16,50 USD

Uzunluk: 1205 mm Koli: 20 Ad.
Işık Akısı: 2850 lm

OSRAM LED

Gerilim : 220 V

Neptün LED Bant Armatür

RoHS Compliant | CE | IP20

Teknik Özellikler

| | |
|------------------|--------------|
| Besleme Gerilimi | AC 220-240 V |
| Frekans | 50-60 Hz |
| Lümen/Watt | 80 lm/W |
| Aydınlatma Açısı | 120 ° |
| Led Tipi | 2835 mm |
| CRI | Ra≥80 |
| Çalışma Isısı | -20/+45 °C |
| IP | IP 20 |
| Garanti | 2 Yıl |
| Led Ömrü | 30.000 Saat |

| Kod | Güç | Renk | Fiyat |
|---------------------|------|--------------|-----------|
| AN20-00603 | 18 W | 3000K | 25,80 USD |
| AN20-00633 | 18 W | 6500K | 25,80 USD |
| Uzunluk: 605 mm | | Koli: 20 Ad. | |
| Işık Akısı: 1320 lm | | | |
| Kod | Güç | Renk | Fiyat |
| AN20-01203 | 36 W | 3000K | 37,20 USD |
| AN20-01233 | 36 W | 6500K | 37,20 USD |
| Uzunluk: 1205 mm | | Koli: 10 Ad. | |
| Işık Akısı: 2850 lm | | | |

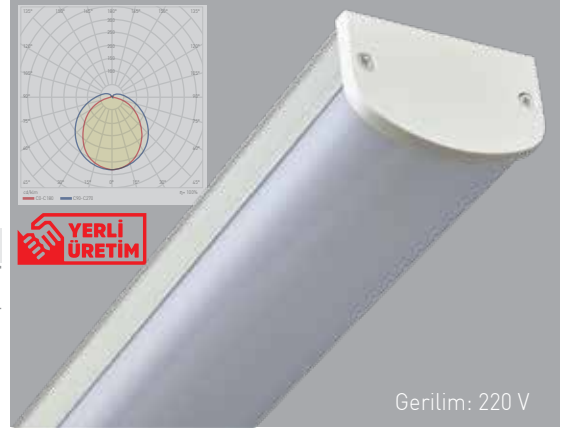

LED Merdiven-Duvar Armatürleri
LED Fixtures

LED Merdiven-Duvar Armatürü

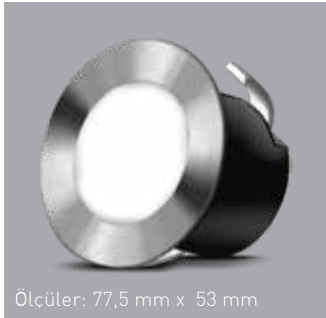

Ölçüler: 77,5 mm x 53 mm

RoHS Compliant | CE | 53 mm | IP20

| Kod | Renk | Fiyat |
|------------|-------|-----------|
| AH07-00704 | 3000K | 14,50 USD |
| AH07-00734 | 6500K | 14,50 USD |
| AH07-00764 | Mavi | 14,50 USD |

Gerilim : 220 V
Güç : 1,5 W
İzolasyon : IP20
Koli Miktarı : 50 ad

LED Merdiven-Duvar Armatürü



Ölçüler: 77,5 mm x 77,5 mm x 53 mm

RoHS Compliant | CE | 53 mm | IP20

| Kod | Renk | Fiyat |
|------------|-------|-----------|
| AH07-00904 | 3000K | 14,50 USD |
| AH07-00934 | 6500K | 14,50 USD |
| AH07-00964 | Mavi | 14,50 USD |

Gerilim : 220 V
Güç : 1,5 W
İzolasyon : IP20
Koli Miktarı : 50 ad

LED Merdiven-Duvar Armatürü

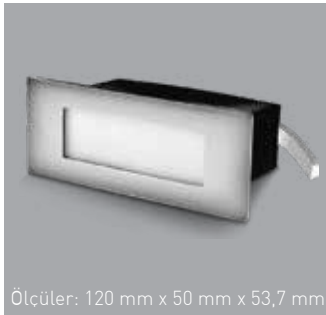

Ölçüler: 120 mm x 50 mm x 53,7 mm

RoHS Compliant | CE | 90mmx35mm | IP20

| Kod | Renk | Fiyat |
|------------|-------|-----------|
| AH07-01104 | 3000K | 14,50 USD |
| AH07-01134 | 6500K | 14,50 USD |
| AH07-01164 | Mavi | 14,50 USD |

Gerilim : 220 V
Güç : 1,5 W
İzolasyon : IP20
Koli Miktarı : 50 ad

Sensörlü LED Merdiven-Duvar Armatürü

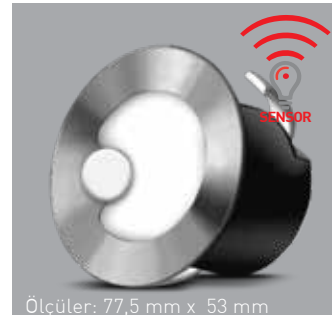

Ölçüler: 77,5 mm x 53 mm

RoHS Compliant | CE | 53 mm | IP20

| Kod | Renk | Fiyat |
|------------|-------|-----------|
| AH07-00604 | 3000K | 18,70 USD |
| AH07-00634 | 6500K | 18,70 USD |
| AH07-00664 | Mavi | 18,70 USD |

Gerilim : 220 V
Güç : 1,5 W
İzolasyon : IP20
Koli Miktarı : 50 ad

Sensörlü LED Merdiven-Duvar Armatürü



Ölçüler: 77,5 mm x 77,5 mm x 53 mm

RoHS Compliant | CE | 53 mm | IP20

| Kod | Renk | Fiyat |
|------------|-------|-----------|
| AH07-00804 | 3000K | 18,70 USD |
| AH07-00834 | 6500K | 18,70 USD |
| AH07-00864 | Mavi | 18,70 USD |

Gerilim : 220 V
Güç : 1,5 W
İzolasyon : IP20
Koli Miktarı : 50 ad

Sensörlü LED Merdiven-Duvar Armatürü



Ölçüler: 120 mm x 50 mm x 53,7 mm

RoHS Compliant | CE | 90mmx35mm | IP20

| Kod | Renk | Fiyat |
|------------|-------|-----------|
| AH07-01004 | 3000K | 18,70 USD |
| AH07-01034 | 6500K | 18,70 USD |
| AH07-01064 | Mavi | 18,70 USD |

Gerilim : 220 V
Güç : 1,5 W
İzolasyon : IP20
Koli Miktarı : 50 ad

LED Bahçe Armatürleri

LED Garden Fixtures

Teras 800 - Bahçe Armatürü



ISO 9001

30.000 hr

IP54

| Kod | Renk | Fiyat |
|------------|-------|------------|
| AG43-03202 | 3000K | 142,00 USD |

Çalışma Isısı: -25°C/+50°C
Materyal: Alüminyum

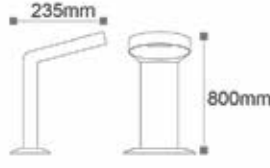

Işık Akısı : 210 lm

Gerilim : 220 V / 50-60 Hz

Güç : 6 W

Koli Miktarı : 4 Ad

Teras 500 - Bahçe Armatürü



ISO 9001

30.000 hr

IP54

| Kod | Renk | Fiyat |
|------------|-------|------------|
| AG43-03002 | 3000K | 122,00 USD |

Çalışma Isısı: -25°C/+50°C
Materyal: Alüminyum

Işık Akısı : 208 lm

Gerilim : 220 V / 50-60 Hz

Güç : 6 W

Koli Miktarı : 4 Ad

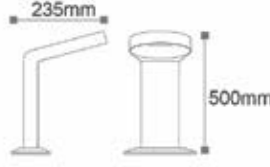

Teras 300 - Bahçe Armatürü



ISO 9001

30.000 hr

IP54

| Kod | Renk | Fiyat |
|------------|-------|------------|
| AG43-02902 | 3000K | 109,00 USD |

Çalışma Isısı: -25°C/+50°C
Materyal: Alüminyum

Işık Akısı : 224 lm

Gerilim : 220 V / 50-60 Hz

Güç : 6 W

Koli Miktarı : 8 Ad

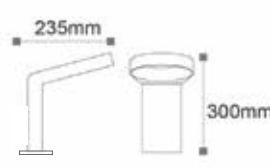

Teras WLA - Bahçe Duvar Aplığı



ISO 9001

30.000 hr

IP54

| Kod | Renk | Fiyat |
|------------|-------|------------|
| AG43-02702 | 3000K | 104,00 USD |

Işık Akısı : 224 lm

Gerilim : 220 V / 50-60 Hz

Güç : 6 W

Koli Miktarı : 8 Ad

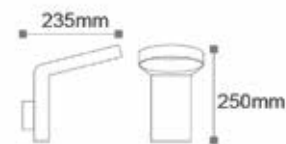

Çalışma Isısı: -25°C/+50°C
Materyal: Alüminyum

OSRAM LED

LED Bahçe Armatürleri

LED Garden Fixtures

ACK

Dallas 800 - Bahçe Armatürü



ISO 9001

30.000 hr

IP54



| Kod | Renk | Fiyat |
|---|--------------------|------------|
| AG43-02302 | 3000K | 142,00 USD |
| Çalışma Isısı: -25°C/+50°C Materyal: Alüminyum | | |
| Işık Akısı | : 224 lm | |
| Gerilim | : 220 V / 50-60 Hz | |
| Güç | : 6 W | |
| Koli Miktarı | : 4 Ad | |

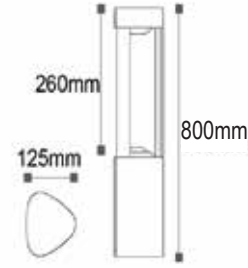

OSRAM LED

Dallas 500 - Bahçe Armatürü



ISO 9001

30.000 hr

IP54



| Kod | Renk | Fiyat |
|---|--------------------|------------|
| AG43-02102 | 3000K | 115,00 USD |
| Çalışma Isısı: -25°C/+50°C Materyal: Alüminyum | | |
| Işık Akısı | : 224 lm | |
| Gerilim | : 220 V / 50-60 Hz | |
| Güç | : 6 W | |
| Koli Miktarı | : 4 Ad | |

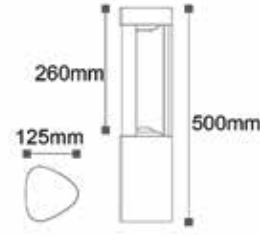

Dallas 300 - Bahçe Armatürü



ISO 9001

30.000 hr

IP54



| Kod | Renk | Fiyat |
|---|--------------------|------------|
| AG43-02002 | 3000K | 109,00 USD |
| Çalışma Isısı: -25°C/+50°C Materyal: Alüminyum | | |
| Işık Akısı | : 224 lm | |
| Gerilim | : 220 V / 50-60 Hz | |
| Güç | : 6 W | |
| Koli Miktarı | : 8 Ad | |

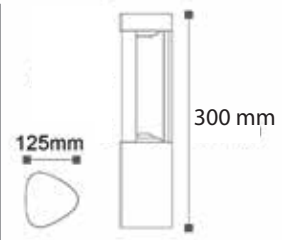

Dallas WLA - Bahçe Duvar Apligi



ISO 9001

30.000 hr

IP54



| Kod | Renk | Fiyat |
|---|--------------------|------------|
| AG43-01802 | 3000K | 104,00 USD |
| Çalışma Isısı: -25°C/+50°C Materyal: Alüminyum | | |
| Işık Akısı | : 224 lm | |
| Gerilim | : 220 V / 50-60 Hz | |
| Güç | : 6 W | |
| Koli Miktarı | : 8 Ad | |

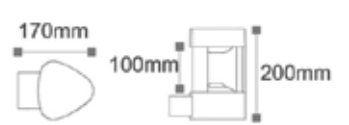

Bahçe Armatürleri

Garden Fixtures

Hera 800 - Bahçe Armatürü

RoHS Compliant | CE | E27 | IP44

| Kod | Kasa | Fiyat |
|------------|-------|-----------|
| AG36-00062 | Siyah | 95,00 USD |

Materyal: Alüminyum

Kullanılabilir

Ampul Gücü : max. 60 W

Duy Tipi : E27

Koli Miktarı : 4 Ad

125mm

800mm



Hera 500 - Bahçe Armatürü

RoHS Compliant | CE | E27 | IP44

| Kod | Kasa | Fiyat |
|------------|-------|-----------|
| AG36-00042 | Siyah | 75,00 USD |

Materyal: Alüminyum

Kullanılabilir

Ampul Gücü : max. 60 W

Duy Tipi : E27

Koli Miktarı : 4 Ad

125mm

500mm

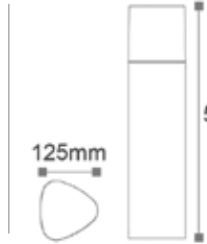

Hera 300 - Bahçe Armatürü

RoHS Compliant | CE | E27 | IP44

| Kod | Kasa | Fiyat |
|------------|-------|-----------|
| AG36-00032 | Siyah | 54,00 USD |

Materyal: Alüminyum

Kullanılabilir

Ampul Gücü : max. 60 W

Duy Tipi : E27

Koli Miktarı : 8 Ad

125mm

300mm

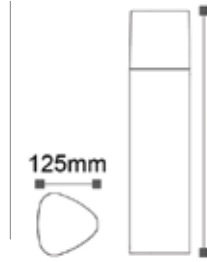

Hera WLA - Bahçe Duvar Aplığı

| Kod | Fiyat |
|------------|-----------|
| AG36-00012 | 58,00 USD |

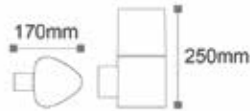

Kullanılabilir

Ampul Gücü : max. 60 W

Duy Tipi : E27

Koli Miktarı : 8 Ad

Materyal: Alüminyum



RoHS Compliant | CE | E27 | IP44

Hera WLS - Sensörlü Bahçe Duvar Aplığı

| Kod | Fiyat |
|------------|-----------|
| AG36-00002 | 84,00 USD |

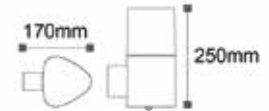

Kullanılabilir

Ampul Gücü : max. 60 W

Duy Tipi : E27

Koli Miktarı : 8 Ad

Materyal: Alüminyum



RoHS Compliant | CE | E27 | IP44

LED Bahçe Aplikleri

LED Garden Fixtures

Norma C - Bahçe Duvar Apliği





| Kod | Kasa | Renk | Fiyat |
|------------------|---|-------|------------|
| AG40-01302 | Siyah | 3000K | 114,00 USD |
| Gerilim | : 220 V / 50-60 Hz | | |
| Güç | : 13 W | | |
| Işık Akısı | : 960 lm  30.000 hr  IP54 | | |
| Aydınlatma Açısı | : 120° | | |
| Koli Miktarı | : 8 ad | | |



Norma D - Bahçe Duvar Apliği



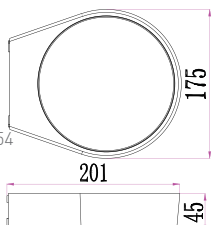

| Kod | Kasa | Renk | Fiyat |
|------------------|---|-------|------------|
| AG40-01202 | Siyah | 3000K | 110,00 USD |
| Gerilim | : 220 V / 50-60 Hz | | |
| Güç | : 10 W | | |
| Işık Akısı | : 435 lm  30.000 hr  IP54 | | |
| Aydınlatma Açısı | : 120° | | |
| Koli Miktarı | : 16 ad | | |

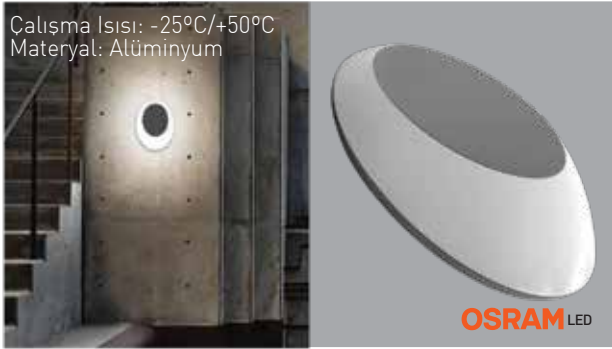

Norma E - Bahçe Duvar Apliği



| Kod | Kasa | Renk | Fiyat |
|------------------|---|-------|------------|
| AG40-01102 | Siyah | 3000K | 121,00 USD |
| Gerilim | : 220 V / 50-60 Hz | | |
| Güç | : 12 W | | |
| Işık Akısı | : 675 lm | | |
| Aydınlatma Açısı | : 120° | | |
| Koli Miktarı | : 8 ad  30.000 hr  IP54 | | |

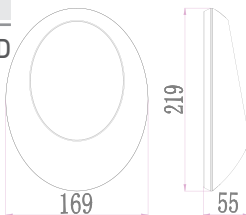



Sirius 2B - Bahçe Duvar Apliği



| Kod | Kasa | Renk | Fiyat |
|--------------|---|-------|-----------|
| AG40-01002 | Siyah | 3000K | 81,00 USD |
| Gerilim | : 220 V / 50-60 Hz | | |
| Güç | : 7 W | | |
| Işık Akısı | : 280 lm  30.000 hr  IP54 | | |
| Koli Miktarı | : 12 Ad | | |

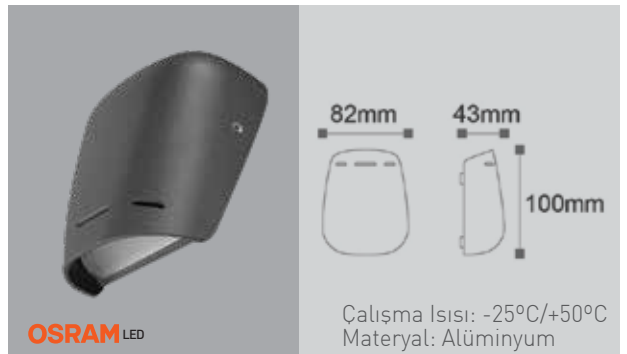

Sirius B - Bahçe Duvar Apliği



| Kod | Kasa | Renk | Fiyat |
|--------------|---|-------|-----------|
| AG40-00902 | Siyah | 3000K | 60,00 USD |
| Gerilim | : 220 V / 50-60 Hz | | |
| Güç | : 3,5 W | | |
| Işık Akısı | : 140 lm  30.000 hr  IP54 | | |
| Koli Miktarı | : 18 Ad | | |



LED Bahçe Aplikleri

LED Garden Fixtures

Sirius 2A - Bahçe Duvar Apliği



Çalışma Isısı: -25°C/+50°C
Materyal: Alüminyum

| Kod | Kasa | Renk | Fiyat |
|------------|-------|-------|-----------|
| AG40-00802 | Siyah | 3000K | 92,00 USD |

Gerilim : 220 V / 50-60 Hz
Güç : 10 W
Işık Akısı : 650 lm
Koli Miktarı : 16 ad
30.000 hr | IP54

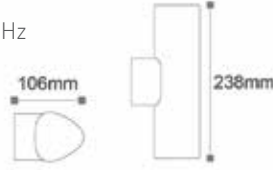

Sirius A - Bahçe Duvar Apliği



| Kod | Kasa | Renk | Fiyat |
|------------|-------|-------|-----------|
| AG40-00702 | Siyah | 3000K | 71,00 USD |

Gerilim : 220 V / 50-60 Hz
Güç : 5 W
Işık Akısı : 315 lm
Koli Miktarı : 16 ad
30.000 hr | IP54

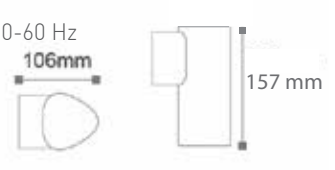

Pirus B - Bahçe Duvar Apliği

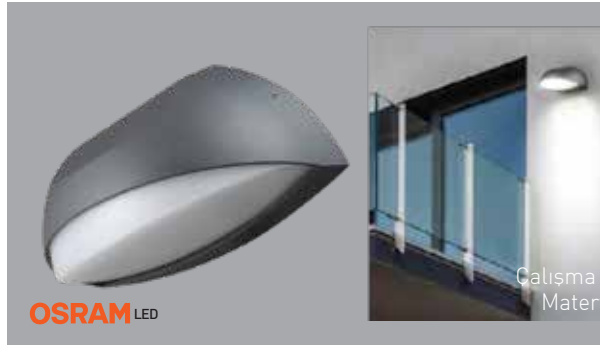

Çalışma Isısı: -25°C/+50°C
Materyal: Alüminyum

| Kod | Kasa | Renk | Fiyat |
|------------|-------|-------|------------|
| AG40-00602 | Siyah | 3000K | 125,00 USD |

Gerilim : 220 V / 50-60 Hz
Güç : 12 W
Işık Akısı : 1020 lm
Koli Miktarı : 8 ad
30.000 hr | IP54

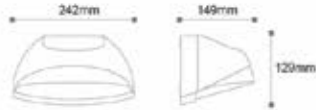

Pirus S - Bahçe Duvar Apliği



| Kod | Kasa | Renk | Fiyat |
|------------|-------|-------|-----------|
| AG40-00502 | Siyah | 3000K | 85,00 USD |

Gerilim : 220 V / 50-60 Hz
Güç : 6 W
Işık Akısı : 475 lm
Koli Miktarı : 12 Ad
30.000 hr | IP54

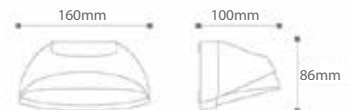

Pirus C - Bahçe Duvar Apliği



Çalışma Isısı: -25°C/+50°C
Materyal: Alüminyum

| Kod | Kasa | Renk | Fiyat |
|------------|-------|-------|-----------|
| AG40-00302 | Siyah | 3000K | 81,00 USD |

Gerilim : 220 V / 50-60 Hz
Güç : 10 W
Işık Akısı : 500 lm
Koli Miktarı : 8 Ad
30.000 hr | IP54

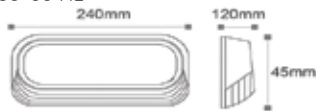

Pirus A - Bahçe Duvar Apliği



Çalışma Isısı: -25°C/+50°C
Materyal: Alüminyum

| Kod | Kasa | Renk | Fiyat |
|------------|-------|-------|-----------|
| AG40-00102 | Siyah | 3000K | 90,00 USD |

Gerilim : 220 V / 50-60 Hz
Güç : 9 W
Işık Akısı : 560 lm
Koli Miktarı : 9 Ad
30.000 hr | IP54

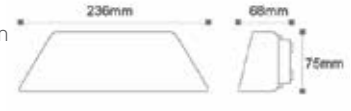

LED Bahçe Aplikleri

LED Garden Fixtures

ACK

Norma A - Bahçe Duvar Apliği



| Kod | Fiyat |
|---|-----------|
| AG40-01502 | 92,00 USD |
| Çalışma Isısı: -25°C/+50°C Materyal: Alüminyum | |
| Renk: 3000K Kasa: Siyah Gerilim: 220 V / 50-60 Hz Güç: 3,5 W Işık Akısı: 32 lm Aydınlatma Açısı: 120° Koli Miktarı: 16 ad | |

RoHS Compliant | CE | ISO 9001 | 30.000 hr | IP54

Norma B - Bahçe Duvar Apliği



| Kod | Fiyat |
|--|------------|
| AG40-01402 | 110,00 USD |
| Çalışma Isısı: -25°C/+50°C Materyal: Alüminyum | |
| Renk: 3000K Kasa: Siyah Gerilim: 220 V / 50-60 Hz Güç: 13 W Işık Akısı: 550 lm Aydınlatma Açısı: 120° Koli Miktarı: 8 ad | |

RoHS Compliant | CE | ISO 9001 | 30.000 hr | IP54

LED Çim Armatürü

RoHS Compliant | CE | IP65



| Kod | Güç | Renk | Işık Ak. | Koli | Fiyat |
|------------|------|-------|----------|-------|-----------|
| AT25-00301 | 10 W | 3000K | 800 lm | 20 ad | 28,00 USD |
| AT25-00331 | 10 W | 6500K | 850 lm | 20 ad | 28,00 USD |
| AT25-00351 | 10 W | Yeşil | - | 20 ad | 28,00 USD |
| AT25-00381 | 10 W | Amber | - | 20 ad | 28,00 USD |

Gerilim: 220 V

Gövde Rengi : Füme

Bahçe Duvar Apliği

E27 | IP44

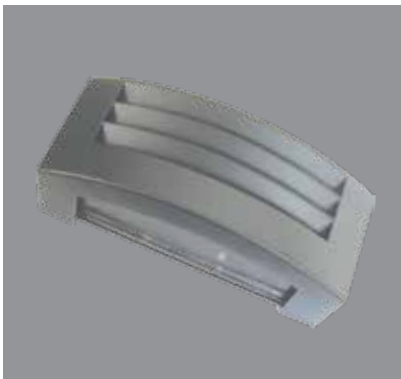

| Kod | Fiyat |
|------------|-----------|
| AG31-00122 | 50,00 USD |

Gövde Rengi : Gri

Kullanılabilir
Ampul Gücü : Max. 60 W
Duy Tipi : E27
Koli Miktarı : 10 ad

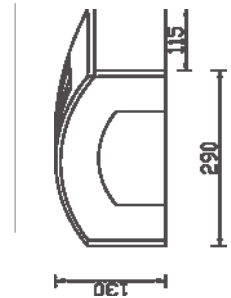

Ikarus - Bahçe Set Üstü Armatürü

E27 | IP44



| Kod | Fiyat |
|------------|-----------|
| AG31-00132 | 82,00 USD |

Gövde Rengi: Siyah

Kullanılabilir
Ampul Gücü : Max. 60 W
Duy Tipi : E27
Koli Miktarı : 6 ad

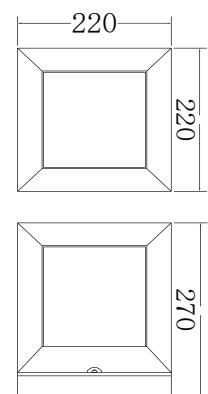

PC LED Bahçe Aplikleri

PC LED Garden Fixtures



Sıva Üstü Çift Yüzlü Duvar Apliği   ISO 9001 

| Kod | Fiyat |
|------------|-----------|
| AH07-02151 | 22,80 USD |

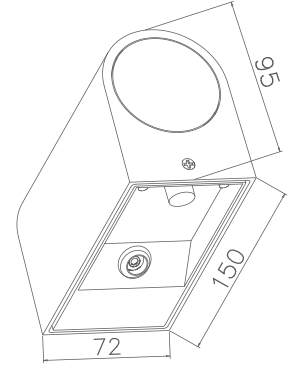

Kullanılabilir
Ampul Gücü : Max. 2 X 50 W
Duy Tipi : GU10
Koli Miktarı : 20 ad

Sıva Üstü Tek Yüzlü Duvar Apliği

  ISO 9001 

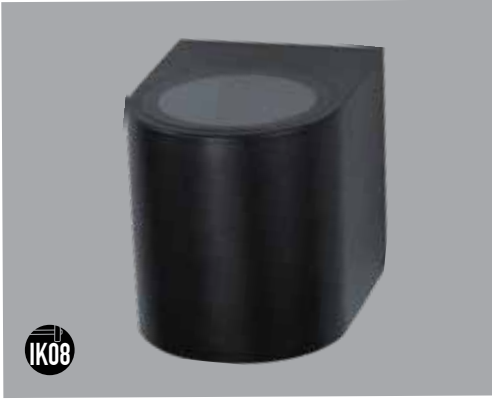

| Kod | Fiyat |
|------------|-----------|
| AH07-02051 | 16,20 USD |

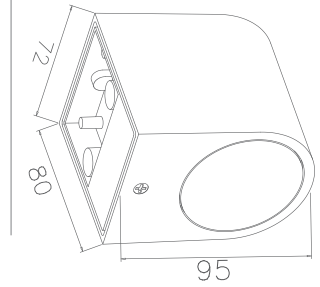

Kullanılabilir
Ampul Gücü : Max. 1 X 50 W
Duy Tipi : GU10
Koli Miktarı : 50 ad

10 W - LED Duvar Armatürü

  ISO 9001 



| Kod | Renk | Işık Akısı | Fiyat |
|------------|-------|------------|-----------|
| AG40-01602 | 3000K | 700 lm | 26,40 USD |
| AG40-01632 | 6500K | 850 lm | 26,40 USD |

Çalışma Isısı: -25°C/+50°C

Gerilim : 220 V / 50-60 Hz
Güç : 10 W
Koli Miktarı : 50 Ad

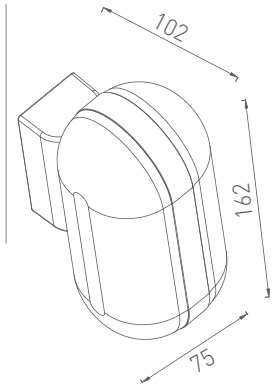

PC Bahçe Armatürleri

PC Garden Fixtures

Limos - Bahçe Armatürü



ISO 9001

IP65

Bahçe Direk Armatürü

| Kod | Boy | Fiyat |
|------------|--------|-----------|
| AG56-06021 | 800 mm | 27,00 USD |

Materyal: PC

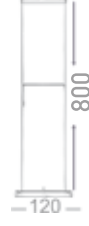
Duy Tipi : E27
Koli Miktarı : 4 Ad

Bahçe Direk Armatürü

| Kod | Boy | Fiyat |
|------------|--------|-----------|
| AG56-06121 | 410 mm | 19,20 USD |

Materyal: PC

Duy Tipi : E27
Koli Miktarı : 10 Ad

Bahçe Direk Armatürü

| Kod | Boy | Fiyat |
|------------|--------|-----------|
| AG56-06221 | 260 mm | 14,40 USD |

Materyal: PC

Duy Tipi : E27
Koli Miktarı : 10 Ad

Limos LED Bahçe Duvar Apliği

LED



| Kod | Renk I. | Fiyat |
|------------|---------|-----------|
| AG50-06301 | 3000K | 16,80 USD |
| AG50-06321 | 6500K | 16,80 USD |

Materyal: PC

Gerilim : 220 V / 50-60 Hz
Güç : 7 W
Işık Akısı : 475 lm
Koli Miktarı : 10 Ad

Limos LED Bahçe Duvar Apliği

LED



| Kod | Renk I. | Fiyat |
|------------|---------|-----------|
| AG50-06401 | 3000K | 25,00 USD |
| AG50-06421 | 6500K | 25,00 USD |

Materyal: PC

Gerilim : 220 V / 50-60 Hz
Güç : 7 W
Işık Akısı : 475 lm
Koli Miktarı : 10 Ad

Aria Bahçe Sarkıt Armatür



Boyut: 220 mm x 90 mm

| Kod | Fiyat |
|------------|-----------|
| AG56-04421 | 10,80 USD |

Materyal: PC

Duy Tipi : E27
Koli Miktarı : 9 Ad

PC Bahçe Armatürleri

PC Garden Fixtures

Aria - Bahçe Armatürü

RoHS
Compliant

CE

ISO 9001

IP65

Bahçe Direk Armatürü

| Kod | Boy | Fiyat |
|------------|--------|-----------|
| AG56-05421 | 800 mm | 27,00 USD |

Materyal: PC

Duy Tipi : E27

Koli Miktarı : 4 Ad



Bahçe Direk Armatürü

| Kod | Boy | Fiyat |
|------------|--------|-----------|
| AG56-05021 | 410 mm | 13,00 USD |

Materyal: PC

Duy Tipi : E27

Koli Miktarı : 10 Ad



Bahçe Direk Armatürü

| Kod | Boy | Fiyat |
|------------|--------|-----------|
| AG56-05121 | 290 mm | 12,00 USD |

Materyal: PC

Duy Tipi : E27

Koli Miktarı : 10 Ad



Bahçe Set Üstü Armatürü

| Kod | Fiyat |
|------------|-----------|
| AG56-05221 | 13,00 USD |

Materyal: PC

Duy Tipi : E27

Koli Miktarı : 6 Ad

Boyut: 340 mm x 180 mm

Aria - Bahçe Duvar Aplikleri:



Boyut: 250 mm x 115 mm

| Kod | Fiyat |
|------------|-----------|
| AG56-04021 | 25,00 USD |

Materyal: PC

Duy Tipi : E27

Koli Miktarı : 10 Ad



Boyut: 340 mm x 210 mm

| Kod | Fiyat |
|------------|-----------|
| AG56-04321 | 14,60 USD |

Materyal: PC

Duy Tipi : E27

Koli Miktarı : 10 Ad



Boyut: 250 mm x 115 mm

| Kod | Fiyat |
|------------|-----------|
| AG56-04121 | 14,40 USD |

Materyal: PC

Duy Tipi : E27

Koli Miktarı : 10 Ad



Boyut: 430 mm x 115 mm

| Kod | Fiyat |
|------------|-----------|
| AG56-04221 | 20,80 USD |

Materyal: PC

Duy Tipi : E27

Koli Miktarı : 10 Ad

PC Bahçe Armatürleri

PC Garden Fixtures

Gaia - Bahçe Armatürü



ISO 9001



Bahçe Direk Armatürü

| Kod | Boy | Fiyat |
|------------|--------|-----------|
| AG55-04421 | 800 mm | 32,00 USD |

Materyal: PC

Duy Tipi : E27
Koli Miktarı : 4 Ad

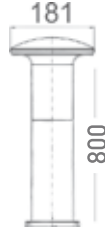

Bahçe Direk Armatürü

| Kod | Boy | Fiyat |
|------------|--------|-----------|
| AG55-04121 | 410 mm | 16,40 USD |

Materyal: PC

Duy Tipi : E27
Koli Miktarı : 6 Ad

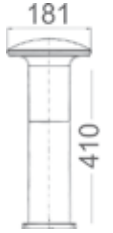

Bahçe Direk Armatürü

| Kod | Boy | Fiyat |
|------------|--------|-----------|
| AG55-04021 | 325 mm | 14,60 USD |

Materyal: PC

Duy Tipi : E27
Koli Miktarı : 6 Ad

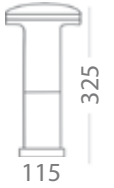

Gaia - Bahçe Duvar Apliği



| Kod | Fiyat |
|------------|-----------|
| AG55-04321 | 16,00 USD |

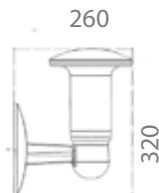

Materyal: PC

Duy Tipi : E27
Koli Miktarı : 6 Ad

Gaia - Bahçe Set Üstü Armatürü



| Kod | Fiyat |
|------------|-----------|
| AG55-04221 | 16,40 USD |



Materyal: PC

Duy Tipi : E27
Koli Miktarı : 6 Ad

PC Bahçe Armatürleri

PC Garden Fixtures

Sardes - Bahçe Armatürü



ISO 9001



Bahçe Direk Armatürü

| Kod | Boy | Fiyat |
|------------|--------|-----------|
| AG55-05321 | 800 mm | 31,00 USD |

Materyal: PC

Duy Tipi : E27

Koli Miktarı : 4 Ad



Bahçe Duvar Apliği

| Kod | Fiyat |
|------------|-----------|
| AG55-05121 | 14,60 USD |

Materyal: PC

Duy Tipi : E27

Koli Miktarı : 6 Ad



Bahçe Set Üstü Armatürü

| Kod | Fiyat |
|------------|-----------|
| AG55-05021 | 14,40 USD |

Materyal: PC

Duy Tipi : E27

Koli Miktarı : 6 Ad



PC Duvar Apliği



| Kod | Fiyat |
|------------|-----------|
| AG56-06050 | 14,40 USD |

Materyal: PC

Duy Tipi : GU10

Koli Miktarı : 20 Ad



PC Duvar Apliği



| Kod | Fiyat |
|------------|-----------|
| AG56-06150 | 20,80 USD |

Materyal: PC

Duy Tipi : GU10

Koli Miktarı : 20 Ad

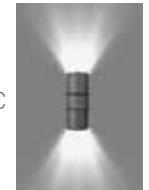

Sipariş sırasında
PC Renkli cam için
seçiminizi belirtin.



Sipariş sırasında
PC Renkli cam için
seçiminizi belirtin.

PC Bahçe Armatürleri

PC Garden Fixtures

PC Duvar Aplığı

RoHS Compliant CE IP65



| Kod | Fiyat |
|------------|-----------|
| AG56-02020 | 21,00 USD |

Materyal: PC



Duy Tipi : GU10
Koli Miktarı : 25 Ad

PC Duvar Aplığı

RoHS Compliant CE IP65



| Kod | Fiyat |
|------------|-----------|
| AG56-02025 | 21,00 USD |

Materyal: PC



Duy Tipi : GU10
Koli Miktarı : 25 Ad

PC Duvar Aplığı

RoHS Compliant CE IP65



| Kod | Fiyat |
|------------|-----------|
| AG56-02026 | 21,00 USD |

Materyal: PC



Duy Tipi : GU10
Koli Miktarı : 25 Ad

PC Duvar Aplığı

RoHS Compliant CE IP65



| Kod | Fiyat |
|------------|-----------|
| AG56-02027 | 21,00 USD |

Materyal: PC



Duy Tipi : GU10
Koli Miktarı : 25 Ad

PC Çim Armatürü

RoHS Compliant CE IP65



Farklı ayaklar yardımıyla
2 şekilde kullanım



| Kod | Fiyat |
|------------|-----------|
| AG56-01050 | 10,80 USD |

Materyal: PC



Duy Tipi : GU10
Koli Miktarı : 25 Ad

PC Çim Armatürü

RoHS Compliant CE IP65



Farklı ayaklar yardımıyla
2 şekilde kullanım



| Kod | Fiyat |
|------------|-----------|
| AG56-01055 | 10,80 USD |

Materyal: PC



Duy Tipi : GU10
Koli Miktarı : 25 Ad

PC Çim Armatürü

RoHS Compliant CE IP65



Farklı ayaklar yardımıyla
2 şekilde kullanım



| Kod | Fiyat |
|------------|-----------|
| AG56-01056 | 10,80 USD |

Materyal: PC

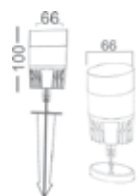

Duy Tipi : GU10
Koli Miktarı : 25 Ad

PC Çim Armatürü

RoHS Compliant CE IP65



Farklı ayaklar yardımıyla
2 şekilde kullanım



| Kod | Fiyat |
|------------|-----------|
| AG56-01057 | 10,80 USD |

Materyal: PC

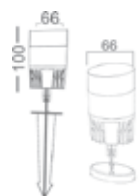

Duy Tipi : GU10
Koli Miktarı : 25 Ad

PC Bahçe Armatürleri

PC Garden Fixtures

PC Bahçe Set Üstü Armatürü



YENİ



| Kod | Fiyat |
|------------|-----------|
| AG57-01021 | 20,00 USD |

Materyal: PC

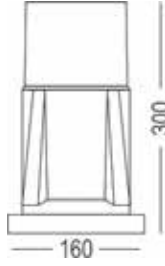

Duy Tipi : E27
Koli Miktarı : 6 Ad

PC Bahçe Set Üstü Armatürü



YENİ



| Kod | Fiyat |
|------------|-----------|
| AG57-01121 | 22,00 USD |

Materyal: PC

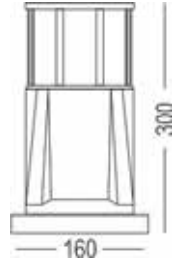

Duy Tipi : E27
Koli Miktarı : 6 Ad

PC Duvar Apliği



YENİ



| Kod | Fiyat |
|------------|-----------|
| AG57-02021 | 19,00 USD |

Materyal: PC

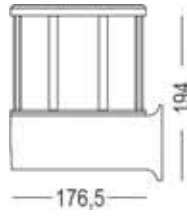

Duy Tipi : E27
Koli Miktarı : 6 Ad

PC Duvar Apliği



YENİ



| Kod | Fiyat |
|------------|-----------|
| AG57-02121 | 16,00 USD |

Materyal: PC



Duy Tipi : E27
Koli Miktarı : 6 Ad

PC Bahçe Direk Armatürü



YENİ



| Kod | Fiyat |
|------------|-----------|
| AG57-03121 | 60,00 USD |

Materyal: PC

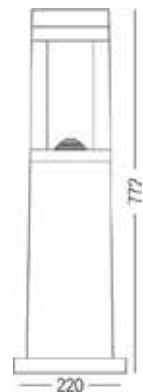

Duy Tipi : GU10
Koli Miktarı : 25 Ad

PC Bahçe Set Üstü Armatürü



YENİ



| Kod | Fiyat |
|------------|-----------|
| AG57-03021 | 32,00 USD |

Materyal: PC

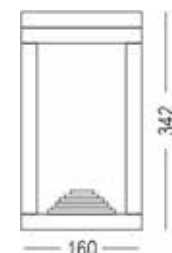

Duy Tipi : GU10
Koli Miktarı : 25 Ad

PC Bahçe Armatürleri

PC Garden Fixtures



Boyut:
44 mm x 25 mm
Duy: E27
Koli: 4 Ad.

| Kod | Fiyat |
|------------|-----------|
| AG55-03121 | 18,00 USD |



Boyut:
50 mm x 18 mm
Duy: E27
Koli: 4 Ad.

| Kod | Fiyat |
|------------|-----------|
| AG55-03221 | 18,00 USD |



Boyut:
47 mm x 18 mm
Duy: E27
Koli: 4 Ad.

| Kod | Fiyat |
|------------|-----------|
| AG55-02021 | 18,00 USD |



Boyut:
47 mm x 18 mm
Duy: E27
Koli: 4 Ad.

| Kod | Fiyat |
|------------|-----------|
| AG55-02121 | 18,00 USD |



Duy: E27
Koli: 4 Ad.

| Kod | Fiyat |
|------------|-----------|
| AG55-01121 | 18,00 USD |



Duy: E27
Koli: 4 Ad.

| Kod | Fiyat |
|------------|-----------|
| AG55-01221 | 55,00 USD |



Duy: E27
Koli: 4 Ad.

| Kod | Fiyat |
|------------|-----------|
| AG55-02221 | 55,00 USD |



Duy: E27
Koli: 4 Ad.

| Kod | Fiyat |
|------------|-----------|
| AG55-02227 | 55,00 USD |



Duy: E27
Koli: 4 Ad.

| Kod | Fiyat |
|------------|-----------|
| AG55-01021 | 18,00 USD |

Boyut:
100 mm x 20 mm

Boyut:
100 mm x 20 mm



Duy: E27
Koli: 4 Ad. Boyut:
45 mm x 25 mm

| Kod | Fiyat |
|------------|-----------|
| AG55-03021 | 18,00 USD |



Duy: E27
Koli: 4 Ad.

| Kod | Fiyat |
|------------|-----------|
| AG55-03321 | 28,00 USD |



Duy: E27
Koli: 4 Ad.

| Kod | Fiyat |
|------------|-----------|
| AG55-03421 | 18,00 USD |

PC Bahçe Armatürleri

PC Garden Fixtures

Lunar - Bahçe Armatürü

RoHS
compliant

CE

ISO 9001

IP54



Duy: E27
Koli: 4 Ad.



| Kod | Fiyat |
|------------|-----------|
| AG55-07021 | 36,00 USD |

Bahçe
Set Üstü
Armatürü



Duy: E27
Koli: 4 Ad.



| Kod | Fiyat |
|------------|-----------|
| AG55-06021 | 33,00 USD |

Bahçe
Set Üstü
Armatürü



Duy: E27
Koli: 4 Ad.



| Kod | Fiyat |
|------------|-----------|
| AG55-08021 | 43,00 USD |

Bahçe
Set Üstü
Armatürü

Bahçe Direk Armatürü

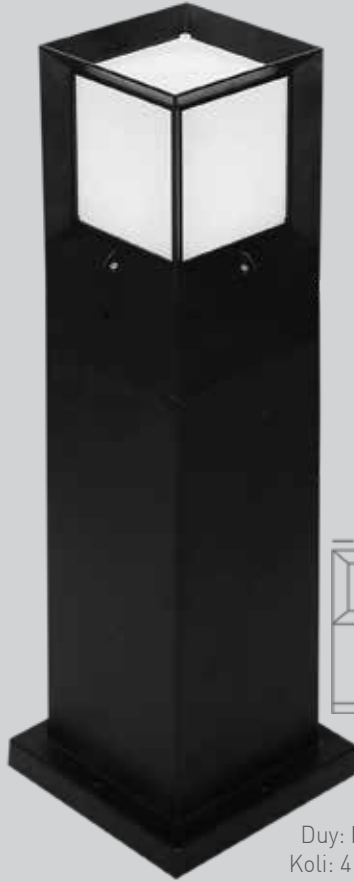

Duy: E27
Koli: 4 Ad.

| Kod | Boy | Fiyat |
|------------|--------|-----------|
| AG55-09101 | 700 mm | 68,00 USD |

Materyal: PC

Bahçe Set Üstü Armatürü



Duy: E27
Koli: 6 Ad.

| Kod | Boy | Fiyat |
|------------|--------|-----------|
| AG55-09001 | 270 mm | 33,00 USD |



Bahçe
Duvar
Aplığı



Duy: E27
Koli: 10 Ad.

| Kod | Fiyat |
|------------|-----------|
| AG56-03021 | 22,00 USD |

PC Masa Lambaları

PC Table Lamps

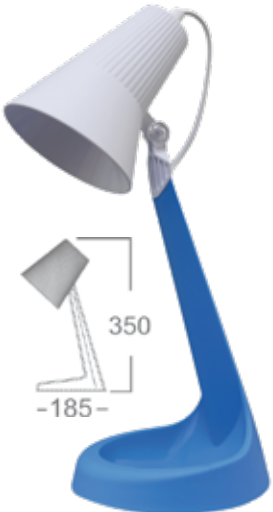

| Kod | Fiyat |
|------------|-----------|
| AA90-00029 | 16,00 USD |



Duy: E14
Koli: 8 Ad.

| Kod | Fiyat |
|------------|-----------|
| AA90-00129 | 16,00 USD |



Duy: E14
Koli: 8 Ad.

| Kod | Fiyat |
|------------|-----------|
| AA90-00229 | 16,00 USD |



Duy: E14
Koli: 8 Ad.

| Kod | Fiyat |
|------------|-----------|
| AA90-00329 | 16,00 USD |



Duy: E14
Koli: 8 Ad.

| Kod | Fiyat |
|------------|-----------|
| AA90-00429 | 16,00 USD |

LED Ray Armatürleri

LED Tracklight

ACK

LED Ray Armatürleri

RoHS
Compliant

CE

ISO 9001

30.000 hr

24°
45°

IP20

Gövde ve driver kutusu alüminyum enjeksiyon malzemeden olup, yüzey işlemleri yapıldıktan sonra textüre elektrostatik boya ile istenilen renkte boyanabilir. Besleme soketi standart monofaze isteğe bağlı olarak trifaze üretilebilir.

Anodize alüminyum reflektör ve yüksek ışık geçirgenliğine sahip 3mm tamperli cam ile korunmaktadır. COB led teknolojisi ile hotspot yapmayan homojen ışık dağılımına sahiptir. 24 ve 45 derece standart çıkış açısına sahip olup projeye özel istenilen açıda özel üretim yapılabilir. Mağaza ortamına uygun 3000-4000-6500K 80 ve üzeri CRI değerinde yüksek verimli ledler ile kumaş dokuları ve renkleri daha canlı ve göz alıcı gözükcektir.

Titreşimsiz sağlıklı ışık: Flicker free



OSRAM

Teknik Özellikler

| | | | | |
|------------------------|----------------|----------------|----------------|----------------|
| Güç Tüketimi | 30 W +/- 5% | 36 W +/- 5% | 40 W +/- 5% | 50 W +/- 5% |
| Besleme Gerilimi | AC 220-240 V | AC 220-240 V | AC 220-240 V | AC 220-240 V |
| Besleme Akımı | 0,130 A | 0,156 A | 0,173 A | 0,217 A |
| Frekans | 50-60 Hz | 50-60 Hz | 50-60 Hz | 50-60 Hz |
| Güç Faktörü Düzeltmesi | 0,98 Pf | 0,98 Pf | 0,98 Pf | 0,98 Pf |
| Driver Verimliliği | 90 % | 90 % | 90 % | 90 % |
| Lümen/Watt | 115 lm/W ~ | 115 lm/W ~ | 115 lm/W | 115 lm/W |
| Aydınlatma Açısı | 24°-45° | 24°-45° | 24°-45° | 24°-45° |
| Led Tipi | COB 19X19 mm | COB 19X19 mm | COB 19X19 mm | COB 19X19 mm |
| Renk Isısı | 3000-4000-6500 | 3000-4000-6500 | 3000-4000-6500 | 3000-4000-6500 |
| CRI | Ra≥80 | Ra≥80 | Ra≥80 | Ra≥80 |
| Işık Akısı | 3,450 lm | 4,150 lm | 4,600 lm | 5,750 lm |
| Çalışma Isısı | -20/+50 °C | -20/+50 °C | -20/+50 °C | -20/+50 °C |
| IP | IP 20 | IP 20 | IP 20 | IP 20 |
| Garanti | 2 Yıl | 2 Yıl | 2 Yıl | 2 Yıl |
| Led Ömrü | 30.000 Saat | 30.000 Saat | 30.000 Saat | 30.000 Saat |

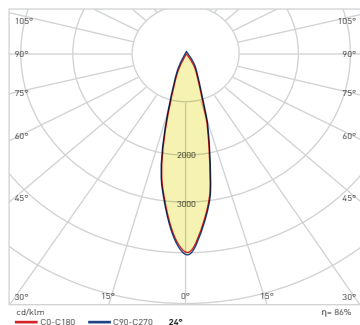
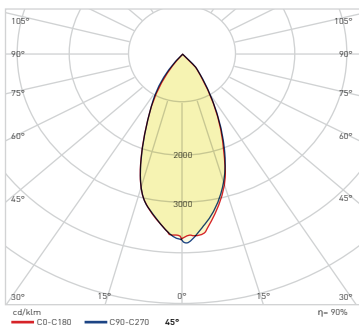

RoHS
Compliant

CE

ISO 9001

30.000 hr

IP20

24°
45°

YERLİ
ÜRETİM

OSRAM

LED Ray Armatürleri

LED Tracklight

30W COB LED Ray Armatür

RoHS Compliant | CE | ISO 9001 | 30.000 hr | 45° | IP20



| Kod | G.Rengi | Renk | I. Akısı | Fiyat |
|------------|---------|-------|----------|-----------|
| AD30-01900 | Beyaz | 3000K | 2700 lm | 39,00 USD |
| AD30-01910 | Beyaz | 4000K | 2700 lm | 39,00 USD |
| AD30-01930 | Beyaz | 6500K | 2700 lm | 39,00 USD |
| AD30-01901 | Siyah | 3000K | 2700 lm | 39,00 USD |
| AD30-01911 | Siyah | 4000K | 2700 lm | 39,00 USD |
| AD30-01931 | Siyah | 6500K | 2700 lm | 39,00 USD |

2 Yıl Garanti
Gerilim : 220 V
Güç : 30 W
Ayd.Açısı: 45°
Koli Mik. : 16 ad



PHILIPS Driver OSRAM Driver Industry Series OSRAM LED

| Kod | G.Rengi | Renk | I. Akısı | Fiyat |
|------------|---------|-------|----------|-----------|
| AD30-11900 | Beyaz | 3000K | 3600 lm | 60,00 USD |
| AD30-11910 | Beyaz | 4000K | 3600 lm | 60,00 USD |
| AD30-11930 | Beyaz | 6500K | 3600 lm | 60,00 USD |
| AD30-11901 | Siyah | 3000K | 3600 lm | 60,00 USD |
| AD30-11911 | Siyah | 4000K | 3600 lm | 60,00 USD |
| AD30-11931 | Siyah | 6500K | 3600 lm | 60,00 USD |

Gerilim : 220 V
Güç : 30 W
Ayd.Açısı: 45°
Koli Mik. : 16 ad



3 Yıl Garanti

30W COB LED Ray Armatür

RoHS Compliant | CE | ISO 9001 | 30.000 hr | 24°/45° | IP20



| Kod | Renk Isısı | G.Rengi | Işık Akısı | Fiyat |
|------------|------------|---------|------------|-----------|
| AD30-04000 | 3000K | Beyaz | 2500 lm | 47,00 USD |
| AD30-04010 | 4000K | Beyaz | 2600 lm | 47,00 USD |
| AD30-04030 | 6500K | Beyaz | 2700 lm | 47,00 USD |
| AD30-04001 | 3000K | Siyah | 2500 lm | 47,00 USD |
| AD30-04011 | 4000K | Siyah | 2600 lm | 47,00 USD |
| AD30-04031 | 6500K | Siyah | 2700 lm | 47,00 USD |

Gerilim: 220 V
Güç : 30 W
Açı : 24°-45°
Koli : 12 ad



10W COB LED Ray Armatür

RoHS Compliant | CE | ISO 9001



Gövde Rengi: Siyah

| Kod | Renk | Fiyat |
|------------|-------|-----------|
| AD30-11001 | 3000K | 23,00 USD |
| AD30-11011 | 4000K | 23,00 USD |
| AD30-11031 | 6500K | 23,00 USD |

2 Yıl Garanti IP20
Gerilim : 220 V
Güç : 10 W
Işık Akısı : 700 lm
Aydınlatma Açısı : 45°
Koli Miktarı : 20 ad

10W COB LED Ray Armatür

RoHS Compliant | CE | ISO 9001



Gövde Rengi: Beyaz

| Kod | Renk | Fiyat |
|------------|-------|-----------|
| AD30-11000 | 3000K | 23,00 USD |
| AD30-11010 | 4000K | 23,00 USD |
| AD30-11030 | 6500K | 23,00 USD |

2 Yıl Garanti IP20
Gerilim : 220 V
Güç : 10 W
Işık Akısı : 700 lm
Aydınlatma Açısı : 45°
Koli Miktarı : 20 ad

LED Ray Armatürleri

LED Tracklight

40W COB LED Ray Armatür

RoHS Compliant | CE | ISO 9001 | 30.000 hr | 24°/45° | IP20



| Kod | Renk Isısı | G.Rengi | Işık Akısı | Fiyat |
|------------|------------|---------|------------|-----------|
| AD30-14600 | 3000K | Beyaz | 4350 lm | 60,00 USD |
| AD30-14610 | 4000K | Beyaz | 4500 lm | 60,00 USD |
| AD30-14630 | 6500K | Beyaz | 4600 lm | 60,00 USD |
| AD30-14601 | 3000K | Siyah | 4350 lm | 60,00 USD |
| AD30-14611 | 4000K | Siyah | 4500 lm | 60,00 USD |
| AD30-14631 | 6500K | Siyah | 4600 lm | 60,00 USD |

Gerilim: 220 V
Güç : 40 W
Açı : 24°-45°
Koli : 8 ad



PHILIPS Driver OSRAM Driver Industry Series OSRAM LED

50W COB LED Ray Armatür

RoHS Compliant | CE | ISO 9001 | 30.000 hr | 24°/45° | IP20



| Kod | Renk Isısı | G.Rengi | Işık Akısı | Fiyat |
|------------|------------|---------|------------|-----------|
| AD30-24600 | 3000K | Beyaz | 5500 lm | 70,00 USD |
| AD30-24610 | 4000K | Beyaz | 5600 lm | 70,00 USD |
| AD30-24630 | 6500K | Beyaz | 5750 lm | 70,00 USD |
| AD30-24601 | 3000K | Siyah | 5500 lm | 70,00 USD |
| AD30-24611 | 4000K | Siyah | 5600 lm | 70,00 USD |
| AD30-24631 | 6500K | Siyah | 5750 lm | 70,00 USD |

Gerilim: 220 V
Güç : 50 W
Açı : 24°-45°
Koli : 12 ad



PHILIPS Driver OSRAM Driver Industry Series OSRAM LED

40W COB LED Ray Armatür

RoHS Compliant | CE | ISO 9001 | 30.000 hr | 24°/45° | IP20



| Kod | Renk Isısı | G.Rengi | Işık Akısı | Fiyat |
|------------|------------|---------|------------|-----------|
| AD30-14700 | 3000K | Beyaz | 3300 lm | 60,00 USD |
| AD30-14710 | 4000K | Beyaz | 3350 lm | 60,00 USD |
| AD30-14730 | 6500K | Beyaz | 3450 lm | 60,00 USD |
| AD30-14701 | 3000K | Siyah | 3300 lm | 60,00 USD |
| AD30-14711 | 4000K | Siyah | 3350 lm | 60,00 USD |
| AD30-14731 | 6500K | Siyah | 3450 lm | 60,00 USD |

Gerilim: 220 V
Güç : 40 W
Açı : 24°-45°
Koli : 12 ad



PHILIPS Driver OSRAM Driver Industry Series OSRAM LED

30W COB LED Ray Armatür

RoHS Compliant | CE | ISO 9001 | 30.000 hr | 24°/45° | IP20



| Kod | Renk Isısı | G.Rengi | Işık Akısı | Fiyat |
|------------|------------|---------|------------|-----------|
| AD30-04500 | 3000K | Beyaz | 3300 lm | 50,00 USD |
| AD30-04510 | 4000K | Beyaz | 3350 lm | 50,00 USD |
| AD30-04530 | 6500K | Beyaz | 3450 lm | 50,00 USD |
| AD30-04501 | 3000K | Siyah | 3300 lm | 50,00 USD |
| AD30-04511 | 4000K | Siyah | 3350 lm | 50,00 USD |
| AD30-04531 | 6500K | Siyah | 3450 lm | 50,00 USD |

Gerilim: 220 V
Güç : 30 W
Açı : 24°-45°
Koli : 12 ad



PHILIPS Driver OSRAM Driver Industry Series OSRAM LED

36W COB LED Trifaze Ray Armatür

RoHS Compliant | CE | ISO 9001 | 30.000 hr | 24°/45° | IP20



| Kod | Renk Isısı | G.Rengi | Işık Akısı | Fiyat |
|------------|------------|---------|------------|-----------|
| AD30-14800 | 3000K | Beyaz | 4000 lm | 62,00 USD |
| AD30-14810 | 4000K | Beyaz | 4050 lm | 62,00 USD |
| AD30-14830 | 6500K | Beyaz | 4150 lm | 62,00 USD |
| AD30-14801 | 3000K | Siyah | 4000 lm | 62,00 USD |
| AD30-14811 | 4000K | Siyah | 4050 lm | 62,00 USD |
| AD30-14831 | 6500K | Siyah | 4150 lm | 62,00 USD |

Gerilim: 220 V
Güç : 36 W
Açı : 24°-45°
Koli : 12 ad



PHILIPS Driver OSRAM Driver Industry Series OSRAM LED

LED Ray Armatürleri

LED Tracklight

32W COB LED Ray Armatür

RoHS Compliant | CE | ISO 9001



| Kod | Gövde. | Fiyat |
|----------|--------|-----------|
| 6401-023 | Siyah | 50,00 USD |
| 6401-021 | Beyaz | 50,00 USD |

2 Yıl Garanti

Gerilim : 220 V
Güç : 32 W
Renk : 5000K
Işık Akısı : 2800 lm
Ayd. Açısı : 45°
Koli Miktarı : 12 ad

30.000 hr | 45° | IP20

32W Sıva Üstü COB LED Arm.

RoHS Compliant | CE | ISO 9001



| Kod | Gövde. | Fiyat |
|----------|--------|-----------|
| 6401-025 | Beyaz | 50,00 USD |

2 Yıl Garanti

Gerilim : 220 V
Güç : 32 W
Renk : 5000K
Işık Akısı : 2800 lm
Ayd. Açısı : 45°
Koli Miktarı : 12 ad

30.000 hr | 45° | IP20

Ray Spot Armatürleri

Rail Spots

Ray Soketli, GU10 Duylu Spot Arm. CE | GU10 | IP20



| Kod | Gövde. | Fiyat |
|------------|--------|-----------|
| AD90-00050 | Beyaz | 14,00 USD |
| AD90-00051 | Siyah | 14,00 USD |

BOŞ

70 mm
120 mm
Ø55 mm

YERLİ ÜRETİM

Gerilim : 220 V
Duy Tipi : GU10

Ray Soketli, E27 Duylu Spot Arm. CE | E27 | IP20



| Kod | Gövde. | Fiyat |
|------------|--------|-----------|
| AD90-00020 | Beyaz | 13,00 USD |
| AD90-00023 | Gri | 13,00 USD |
| AD90-00021 | Siyah | 13,00 USD |

BOŞ

Gerilim : 220 V
Duy Tipi : E27

Koli Miktarı: 20 Ad.

Ray Soketli, E27 Duylu Spot Arm. CE | E27 | IP20



| Kod | Gövde. | Fiyat |
|------------|---------|-----------|
| AH18-50100 | Beyaz | 43,00 USD |
| AH18-50101 | Siyah | 43,00 USD |
| AH18-50104 | Kırmızı | 43,00 USD |

BOŞ

YERLİ ÜRETİM

Gerilim : 220 V
Duy Tipi : E27

Ray Soketli, E27 Duylu Spot Arm. CE | E27 | IP20



| Kod | Gövde. | Fiyat |
|------------|--------|-----------|
| AH18-50300 | Beyaz | 51,00 USD |
| AH18-50301 | Siyah | 51,00 USD |

BOŞ

YERLİ ÜRETİM

Gerilim : 220 V
Duy Tipi : E27

Ray Soketli, E27 Duylu Spot Arm. CE | E27 | IP20



| Kod | Gövde. | Fiyat |
|------------|--------|-----------|
| AH18-50200 | Beyaz | 38,00 USD |
| AH18-50201 | Siyah | 38,00 USD |

BOŞ

YERLİ ÜRETİM

Gerilim : 220 V
Duy Tipi : E27

Monofaze Ray



Koli Miktarı: 20 Ad.

| Kod | Uzunluk | Renk | Fiyat |
|------------|---------|-------|-----------|
| AY40-00110 | 1 mt | Beyaz | 7,76 USD |
| AY40-00113 | 1 mt | Gri | 7,76 USD |
| AY40-00111 | 1 mt | Siyah | 7,76 USD |
| AY40-00120 | 2 mt | Beyaz | 15,50 USD |
| AY40-00123 | 2 mt | Gri | 15,50 USD |
| AY40-00121 | 2 mt | Siyah | 15,50 USD |
| AY40-00130 | 3 mt | Beyaz | 23,30 USD |
| AY40-00133 | 3 mt | Gri | 23,30 USD |
| AY40-00131 | 3 mt | Siyah | 23,30 USD |

RoHS Compliant | CE | IP20

Monofaze Ray Enerji Giriş

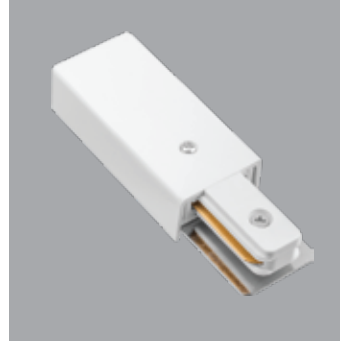

| Kod | Renk | Fiyat |
|------------|-------|----------|
| AY40-00210 | Beyaz | 3,25 USD |
| AY40-00213 | Gri | 3,25 USD |
| AY40-00211 | Siyah | 3,25 USD |

Gerilim : 220 V
Koli Miktarı : 300 ad

RoHS Compliant | CE | IP20

Monofaze Ray Ek Parça



| Kod | Renk | Fiyat |
|------------|-------|----------|
| AY40-00240 | Beyaz | 2,50 USD |
| AY40-00243 | Gri | 2,50 USD |
| AY40-00241 | Siyah | 2,50 USD |

Gerilim : 220 V
Koli Miktarı : 300 ad

RoHS Compliant | CE | IP20

Monofaze Ray L Dönüş



| Kod | Renk | Fiyat |
|------------|-------|----------|
| AY40-00230 | Beyaz | 3,50 USD |
| AY40-00233 | Gri | 3,50 USD |
| AY40-00231 | Siyah | 3,50 USD |

Gerilim : 220 V
Koli Miktarı : 200 ad

RoHS Compliant | CE | IP20

Monofaze Ray T Dönüş



| Kod | Renk | Fiyat |
|------------|-------|----------|
| AY40-00250 | Beyaz | 4,00 USD |
| AY40-00253 | Gri | 4,00 USD |
| AY40-00251 | Siyah | 4,00 USD |

Gerilim : 220 V
Koli Miktarı : 200 ad

RoHS Compliant | CE | IP20

Monofaze Ray Artı Dönüş

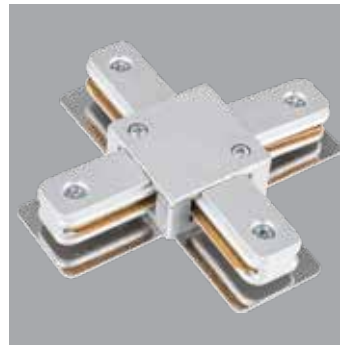

| Kod | Renk | Fiyat |
|------------|-------|----------|
| AY40-00260 | Beyaz | 5,70 USD |
| AY40-00263 | Gri | 5,70 USD |
| AY40-00261 | Siyah | 5,70 USD |

Gerilim : 220 V
Koli Miktarı : 200 ad

RoHS Compliant | CE | IP20

Monofaze Ray Soketi



| Kod | Renk | Fiyat |
|------------|-------|----------|
| AY40-00200 | Beyaz | 2,20 USD |
| AY40-00203 | Gri | 2,20 USD |
| AY40-00201 | Siyah | 2,20 USD |

Gerilim : 220 V
Koli Miktarı : 300 ad

RoHS Compliant | CE | IP20

Monofaze Ray Sonlandırma Kapağı

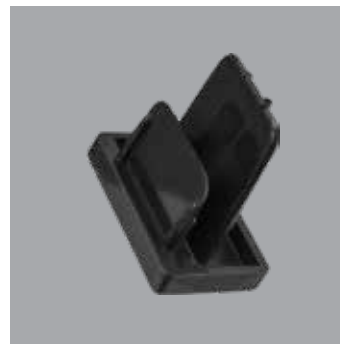

| Kod | Renk | Fiyat |
|------------|-------|----------|
| AY40-00220 | Beyaz | 0,60 USD |
| AY40-00223 | Gri | 0,60 USD |
| AY40-00221 | Siyah | 0,60 USD |

Koli Miktarı : 1000 ad

RoHS Compliant | CE | IP20

Ray Aksesuarları

Tracklight Accessories

Trifaze Ray

RoHS Compliant | CE | IP20



220 V / Koli Mik.: 6 Ad

| Kod | Uzunluk | Renk | Fiyat |
|------------|---------|-------|-----------|
| AY40-02020 | 2 mt | Beyaz | 44,00 USD |
| AY40-02023 | 2 mt | Gri | 44,00 USD |
| AY40-02021 | 2 mt | Siyah | 44,00 USD |
| AY40-02030 | 3 mt | Beyaz | 66,00 USD |
| AY40-02033 | 3 mt | Gri | 66,00 USD |
| AY40-02031 | 3 mt | Siyah | 66,00 USD |

Trifaze Ray Enerji Girişi

RoHS Compliant | CE | IP20



| Kod | Renk | Fiyat |
|------------|-------|----------|
| AY40-02110 | Beyaz | 7,00 USD |
| AY40-02113 | Gri | 7,00 USD |
| AY40-02111 | Siyah | 7,00 USD |

Gerilim : 220 V
Koli Miktarı : 300 ad

Trifaze Ray Artı Dönüşü

RoHS Compliant | CE | IP20



| Kod | Renk | Fiyat |
|------------|-------|-----------|
| AY40-02160 | Beyaz | 20,00 USD |
| AY40-02163 | Gri | 20,00 USD |
| AY40-02161 | Siyah | 20,00 USD |

Gerilim : 220 V
Koli Miktarı : 200 ad

Trifaze Ray L Dönüş

RoHS Compliant | CE | IP20

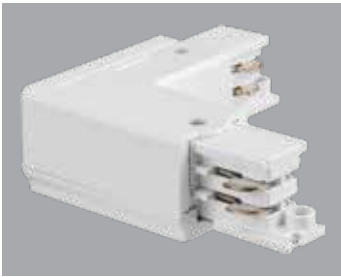

| Kod | Renk | Fiyat |
|------------|-------|----------|
| AY40-02130 | Beyaz | 9,00 USD |
| AY40-02133 | Gri | 9,00 USD |
| AY40-02131 | Siyah | 9,00 USD |

Gerilim : 220 V
Koli Miktarı : 100 ad

Trifaze Ray Soketi

RoHS Compliant | CE | IP20



| Kod | Renk | Fiyat |
|------------|-------|-----------|
| AY40-02100 | Beyaz | 20,00 USD |
| AY40-02103 | Gri | 20,00 USD |
| AY40-02101 | Siyah | 20,00 USD |

Gerilim : 220 V
Koli Miktarı : 300 ad

Trifaze Ray Ek Parça

RoHS Compliant | CE | IP20



| Kod | Renk | Fiyat |
|------------|-------|----------|
| AY40-02140 | Beyaz | 7,20 USD |
| AY40-02143 | Gri | 7,20 USD |
| AY40-02141 | Siyah | 7,20 USD |

Gerilim : 220 V
Koli Miktarı : 500 ad

Trifaze Ray T Dönüş

RoHS Compliant | CE | IP20



| Kod | Renk | Fiyat |
|------------|-------|-----------|
| AY40-02150 | Beyaz | 15,60 USD |
| AY40-02153 | Gri | 15,60 USD |
| AY40-02151 | Siyah | 15,60 USD |

Gerilim : 220 V
Koli Miktarı : 200 ad

Trifaze Ray Sonlandırma

RoHS Compliant | CE | IP20



| Kod | Renk | Fiyat |
|------------|-------|----------|
| AY40-02120 | Beyaz | 0,66 USD |
| AY40-02123 | Gri | 0,66 USD |
| AY40-02121 | Siyah | 0,66 USD |

Koli Miktarı : 1000 ad

LED Salyangoz Armatürleri

LED Gimbal Downlights

30W COB LED Salyangoz Armatür



| Kod | Renk I. | I. Akısı | Fiyat |
|------------|---------|----------|-----------|
| AD36-00600 | 3000K | 3350 lm | 85,00 USD |
| AD36-00610 | 4000K | 3400 lm | 85,00 USD |
| AD36-00630 | 6500K | 3450 lm | 85,00 USD |

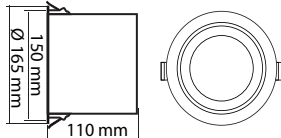

Gerilim : 220 V
Güç : 30 W
Koli Miktarı : 12 Ad

Kesim Ölçüsü : 150 mm
Aydınlatma Açısı : 24°-45°
Gövde Rengi : Beyaz

36W COB LED Salyangoz Armatür



| Kod | Renk I. | I. Akısı | Fiyat |
|------------|---------|----------|-----------|
| AD36-01300 | 3000K | 4000 lm | 73,00 USD |
| AD36-01310 | 4000K | 4050 lm | 73,00 USD |
| AD36-01330 | 6500K | 4150 lm | 73,00 USD |

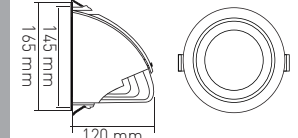

Gerilim : 220 V
Güç : 36 W
Koli Miktarı : 12 Ad

Kesim Ölçüsü : 145 mm
Aydınlatma Açısı : 24°-45°
Gövde Rengi : Beyaz

30W COB LED Salyangoz Armatür



| Kod | Renk I. | I. Akısı | Fiyat |
|------------|---------|----------|-----------|
| AD36-00300 | 3000K | 2500 lm | 51,00 USD |
| AD36-00310 | 4000K | 2600 lm | 51,00 USD |
| AD36-00330 | 6500K | 2700 lm | 51,00 USD |

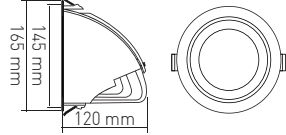

| | | | |
|--------------|---------|------------------|-----------|
| Gerilim | : 220 V | Kesim Ölçüsü | : 145 mm |
| Güç | : 30 W | Aydınlatma Açısı | : 24°-45° |
| Koli Miktarı | : 12 Ad | Gövde Rengi | : Beyaz |

30W COB LED Salyangoz Armatür



| Kod | Renk I. | I. Akısı | Fiyat |
|------------|---------|----------|-----------|
| AD36-00400 | 3000K | 2400 lm | 51,00 USD |
| AD36-00410 | 4000K | 2450 lm | 51,00 USD |
| AD36-00430 | 6500K | 2550 lm | 51,00 USD |

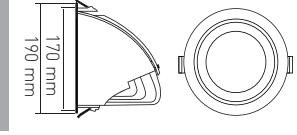

| | | | |
|--------------|---------|------------------|----------|
| Gerilim | : 220 V | Kesim Ölçüsü | : 170 mm |
| Güç | : 30 W | Aydınlatma Açısı | : 160° |
| Koli Miktarı | : 6 Ad | Gövde Rengi | : Beyaz |

Sıva Altı LED Spotlar

LED Downlights

İkili Sıva Altı LED Spot

RoHS Compliant | CE | ISO 9001 | 30.000 hr | $\lambda_{450}^{24^\circ}$ | IP20

2 x 30 W

| | Kod | Renk I. | Işık Akısı | Fiyat |
|-------------|------------|---------|------------|------------|
| Beyaz Gövde | AH03-07100 | 3000K | 7080 lm | 100,00 USD |
| | AH03-07110 | 4000K | 7380 lm | 100,00 USD |
| | AH03-07130 | 6500K | 7980 lm | 100,00 USD |
| Siyah Gövde | AH03-07101 | 3000K | 7080 lm | 100,00 USD |
| | AH03-07111 | 4000K | 7380 lm | 100,00 USD |
| | AH03-07131 | 6500K | 7980 lm | 100,00 USD |

| | |
|----------|-------------|
| Gerilim: | 220 V |
| Açı : | 30°-45°-60° |



2 x 40 W

| | Kod | Renk I. | Işık Akısı | Fiyat |
|-------------|------------|---------|------------|------------|
| Beyaz Gövde | AH03-27100 | 3000K | 8900 lm | 104,00 USD |
| | AH03-27110 | 4000K | 9360 lm | 104,00 USD |
| | AH03-27130 | 6500K | 10260 lm | 104,00 USD |
| Siyah Gövde | AH03-27101 | 3000K | 8900 lm | 104,00 USD |
| | AH03-27111 | 4000K | 9360 lm | 104,00 USD |
| | AH03-27131 | 6500K | 10260 lm | 104,00 USD |

| | |
|---------------|-------------------------|
| Ölçüler: | 190 mm x 380 mm x 89 mm |
| Kesim Ölçüsü: | 170 mm x 360 mm |

Tekli Kare Sıva Altı LED Spot

RoHS Compliant | CE | ISO 9001 | 30.000 hr | $\lambda_{450}^{24^\circ}$ | IP20

30 W

| | Kod | Renk I. | Işık Akısı | Fiyat |
|-------------|------------|---------|------------|-----------|
| Beyaz Gövde | AH03-06100 | 3000K | 3540 lm | 50,00 USD |
| | AH03-06110 | 4000K | 3690 lm | 50,00 USD |
| | AH03-06130 | 6500K | 3990 lm | 50,00 USD |
| Siyah Gövde | AH03-06101 | 3000K | 3540 lm | 50,00 USD |
| | AH03-06111 | 4000K | 3690 lm | 50,00 USD |
| | AH03-06131 | 6500K | 3990 lm | 50,00 USD |

| | |
|----------|-------------|
| Gerilim: | 220 V |
| Açı : | 30°-45°-60° |



40 W

| | Kod | Renk I. | Işık Akısı | Fiyat |
|-------------|------------|---------|------------|-----------|
| Beyaz Gövde | AH03-26100 | 3000K | 4450 lm | 52,00 USD |
| | AH03-26110 | 4000K | 4680 lm | 52,00 USD |
| | AH03-26130 | 6500K | 5130 lm | 52,00 USD |
| Siyah Gövde | AH03-26101 | 3000K | 4450 lm | 52,00 USD |
| | AH03-26111 | 4000K | 4680 lm | 52,00 USD |
| | AH03-26131 | 6500K | 5130 lm | 52,00 USD |

| | |
|---------------|-------------------------|
| Ölçüler: | 190 mm x 190 mm x 89 mm |
| Kesim Ölçüsü: | Ø170 mm |

Tekli Yuvarlak Sıva Altı LED Spot

RoHS Compliant | CE | ISO 9001 | 30.000 hr | $\lambda_{450}^{24^\circ}$ | IP20

30 W

| | Kod | Renk I. | Işık Akısı | Fiyat |
|-------------|------------|---------|------------|-----------|
| Beyaz Gövde | AH03-06000 | 3000K | 3540 lm | 50,00 USD |
| | AH03-06010 | 4000K | 3690 lm | 50,00 USD |
| | AH03-06030 | 6500K | 3990 lm | 50,00 USD |
| Siyah Gövde | AH03-06001 | 3000K | 3540 lm | 50,00 USD |
| | AH03-06011 | 4000K | 3690 lm | 50,00 USD |
| | AH03-06031 | 6500K | 3990 lm | 50,00 USD |

| | |
|----------|-------------|
| Gerilim: | 220 V |
| Açı : | 30°-45°-60° |



40 W

| | Kod | Renk I. | Işık Akısı | Fiyat |
|-------------|------------|---------|------------|-----------|
| Beyaz Gövde | AH03-26000 | 3000K | 4450 lm | 52,00 USD |
| | AH03-26010 | 4000K | 4680 lm | 52,00 USD |
| | AH03-26030 | 6500K | 5130 lm | 52,00 USD |
| Siyah Gövde | AH03-26001 | 3000K | 4450 lm | 52,00 USD |
| | AH03-26011 | 4000K | 4680 lm | 52,00 USD |
| | AH03-26031 | 6500K | 5130 lm | 52,00 USD |

| | |
|---------------|-----------------|
| Ölçüler: | Ø185 mm x 89 mm |
| Kesim Ölçüsü: | Ø170 mm |

LED Tavan/Duvar Armatürleri ve Aplikleri

Ceiling/Wall Fixtures and Apliques

6W AWA LED Duvar Armatürü

IP20



| Kod | Renk I. | Fiyat |
|------------|---------|-----------|
| AH07-03200 | 3000K | 22,00 USD |
| AH07-03210 | 4000K | 22,00 USD |
| AH07-03230 | 6500K | 22,00 USD |
| AH07-03201 | 3000K | 22,00 USD |
| AH07-03211 | 4000K | 22,00 USD |
| AH07-03231 | 6500K | 22,00 USD |

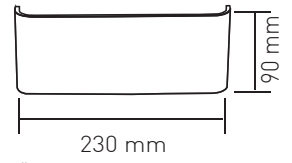

Özel boy ve renkte ürün talepleriniz için iletişime geçiniz.

Gerilim: 220-240 V / CRI: Ra≥80 / Koli Miktarı: 30 Ad.

12W AWA LED Duvar Armatürü

IP20



| Kod | Renk I. | Fiyat |
|------------|---------|-----------|
| AH07-03300 | 3000K | 28,60 USD |
| AH07-03310 | 4000K | 28,60 USD |
| AH07-03330 | 6500K | 28,60 USD |
| AH07-03301 | 3000K | 28,60 USD |
| AH07-03311 | 4000K | 28,60 USD |
| AH07-03331 | 6500K | 28,60 USD |

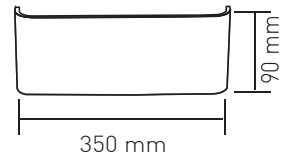

Özel boy ve renkte ürün talepleriniz için iletişime geçiniz.

Gerilim: 220-240 V / CRI: Ra≥80 / Koli Miktarı: 30 Ad.

18W AWA LED Duvar Armatürü

IP20



| Kod | Renk I. | Fiyat |
|------------|---------|-----------|
| AH07-03700 | 3000K | 36,00 USD |
| AH07-03710 | 4000K | 36,00 USD |
| AH07-03730 | 6500K | 36,00 USD |
| AH07-03701 | 3000K | 36,00 USD |
| AH07-03711 | 4000K | 36,00 USD |
| AH07-03731 | 6500K | 36,00 USD |

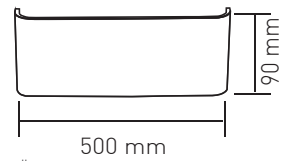

Özel boy ve renkte ürün talepleriniz için iletişime geçiniz.

Gerilim: 220-240 V / CRI: Ra≥80 / Koli Miktarı: 30 Ad.

6W LED'li Tablo Apliği

RoHS Compliant

CE

ISO 9001

30.000 hr

35°

IP20

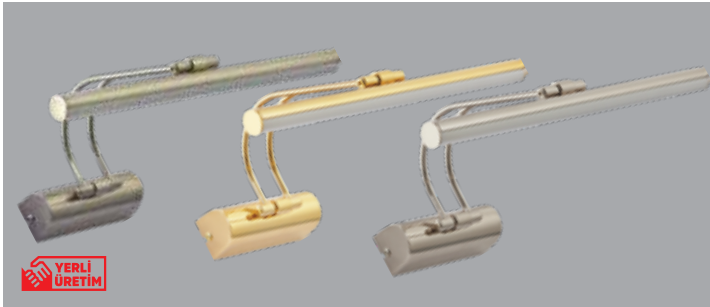

| Kod | Gövde | Renk I. | Fiyat |
|------------|---------|---------|-----------|
| AH10-00107 | Gold | 3000K | 30,00 USD |
| AH10-00137 | Gold | 6500K | 30,00 USD |
| AH10-00104 | Saten | 3000K | 30,00 USD |
| AH10-00134 | Saten | 6500K | 30,00 USD |
| AH10-00105 | Krom | 3000K | 30,00 USD |
| AH10-00135 | Krom | 6500K | 30,00 USD |
| AH10-00109 | Eskitme | 3000K | 30,00 USD |
| AH10-00139 | Eskitme | 6500K | 30,00 USD |

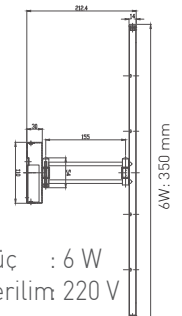

Güç : 6 W
Gerilim 220 V

4W LED Duvar Apliği

RoHS Compliant

CE

ISO 9001

30.000 hr

5°/90°

IP65



| Kod | Güç | Renk | I.Akısı | Gövde | Fiyat |
|------------|-----|-------|---------|-------|-----------|
| AH07-03500 | 4 W | 3000K | 260 lm | Beyaz | 28,80 USD |
| AH07-03501 | 4 W | 3000K | 260 lm | Siyah | 28,80 USD |

Aydınlatma Açısı: 0°-75°

Gerilim : 220 V
Koli Miktarı : 50 Ad

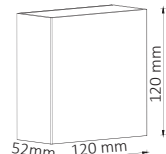

Materyal: Plastik

3W LED Duvar Apliği

IP65



| Kod | Renk | Fiyat |
|------------|-------|-----------|
| AH07-04801 | 3000K | 25,80 USD |

Aydınlatma Açısı: 5°-90°

Gerilim: 220 V
I.Akısı: 120 lm
Gövde: Siyah
Koli M.: 20 Ad.

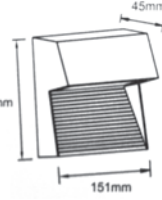

3W LED Duvar Apliği

IP65



| Kod | Renk | Fiyat |
|------------|-------|-----------|
| AH07-04701 | 3000K | 26,40 USD |

Aydınlatma Açısı: 87°

Gerilim: 220 V
I.Akısı: 120 lm
Gövde: Siyah
Koli M.: 20 Ad.

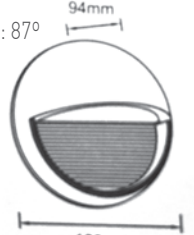

12W LED Duvar Apliği

IP65

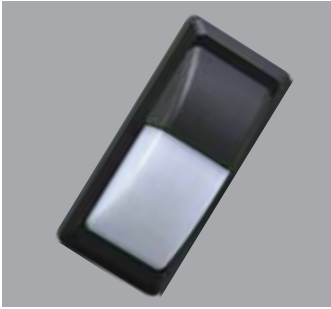

| Kod | Renk | Fiyat |
|------------|-------|-----------|
| AH07-04601 | 3000K | 26,40 USD |

Aydınlatma Açısı: 120°

Gerilim: 220 V
I.Akısı: 500 lm
Gövde: Siyah
Koli M.: 20 Ad.

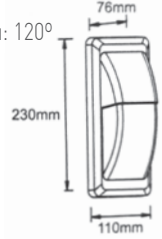

12W LED Duvar Apliği

IP65



| Kod | Renk | Fiyat |
|------------|-------|-----------|
| AH07-04501 | 3000K | 26,40 USD |

Aydınlatma Açısı: 120°

Gerilim: 220 V
I.Akısı: 500 lm
Gövde: Siyah
Koli M.: 20 Ad.

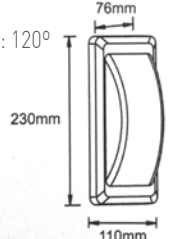

2W LED Duvar Apliği

IP65

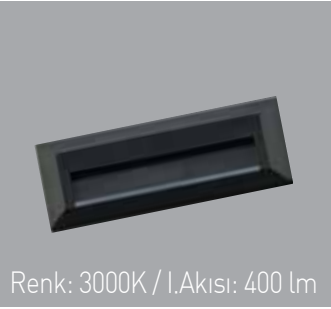

| Kod | Renk | Fiyat |
|------------|-------|-----------|
| AH07-04201 | 3000K | 16,80 USD |

Aydınlatma Açısı: 24°

Gerilim: 220 V
I.Akısı: 60 lm
Gövde: Siyah
Koli M.: 50 Ad.

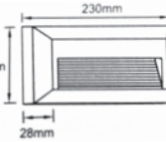

Renk: 3000K / I.Akısı: 400 lm

9W LED Duvar Apliği

IP65

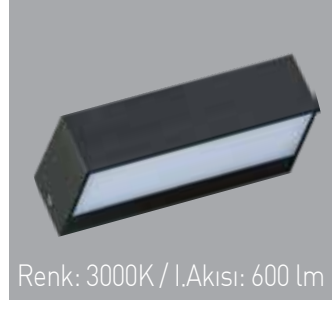

| Kod | Renk | Fiyat |
|------------|-------|-----------|
| AH07-04301 | 3000K | 28,80 USD |

Aydınlatma Açısı: 24°

Gerilim: 220 V
I.Akısı: 400 lm
Gövde: Siyah
Koli M.: 40 Ad.

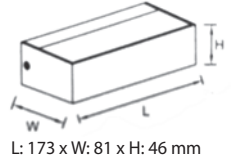

L: 173 x W: 81 x H: 46 mm

2W LED Duvar Apliği

IP65



| Kod | Renk | Fiyat |
|------------|-------|-----------|
| AH07-04001 | 3000K | 16,80 USD |

Aydınlatma Açısı: 35°

Gerilim: 220 V
I.Akısı: 60 lm
Gövde: Siyah
Koli M.: 50 Ad.

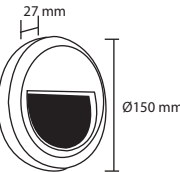

2W LED Duvar Apliği

IP65



| Kod | Renk | Fiyat |
|------------|-------|-----------|
| AH07-04101 | 3000K | 16,80 USD |

Aydınlatma Açısı: 35°

Gerilim: 220 V
I.Akısı: 60 lm
Gövde: Siyah
Koli M.: 50 Ad.

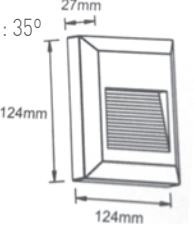

2W AWA LED Duvar Armatürü

IP65



| Kod | Renk | Fiyat |
|------------|-------|-----------|
| AH07-01401 | 3000K | 13,20 USD |

Gerilim: 220 V
I.Akısı: 40 lm
Gövde: Beyaz
Koli M.: 50 Ad.

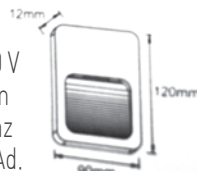

2W AWA LED Duvar Armatürü

IP65



| Kod | Renk | Fiyat |
|------------|-------|-----------|
| AH07-01400 | 3000K | 13,20 USD |

Gerilim: 220 V
I.Akısı: 40 lm
Gövde: Siyah
Koli M.: 50 Ad.

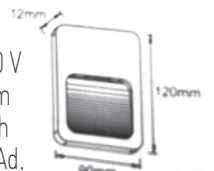

LED Tavan/Duvar Armatürleri ve Aplikleri

Ceiling/Wall Fixtures and Apliques

8W AWA LED Duvar Armatürü

IP20

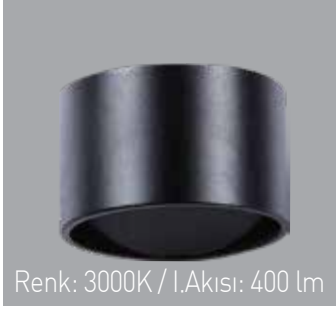

Renk: 3000K / I.Akısı: 400 lm

| Kod | Renk | Fiyat |
|------------|-------|-----------|
| AH07-03001 | 3000K | 28,00 USD |

Gerilim: 220 V
I.Akısı: 400 lm
Gövde: Siyah
Koli M.: 30 Ad.

6W LED Duvar Apliği

IP65



Renk: 3000K / I.Akısı: 400 lm

| Kod | Renk | Fiyat |
|------------|-------|-----------|
| AH07-04401 | 3000K | 26,40 USD |

Aydınlatma Açısı: 24°

Gerilim: 220 V
I.Akısı: 300 lm
Gövde: Siyah
Koli M.: 20 Ad.

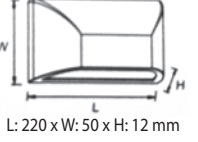

12W Carina LED Bahçe Tavan ve Duvar Armatürü

IP65



| Kod | Renk | Fiyat |
|------------|-------|-----------|
| AG39-00101 | 3000K | 48,00 USD |

Aydınlatma Açısı: 150°

IP65 Ø 169 mm X h 100 mm

Gerilim: 220 V
I.Akısı: 900 lm
Gövde: Siyah-Yuvarlak
Koli M.: 20 Ad.

12W Carina LED Bahçe Tavan ve Duvar Armatürü

IP65



| Kod | Renk | Fiyat |
|------------|-------|-----------|
| AG39-00201 | 3000K | 48,00 USD |

Aydınlatma Açısı: 150°

IP65 160 mm X h 100 mm

Gerilim: 220 V
I.Akısı: 900 lm
Gövde: Siyah-Kare
Koli M.: 20 Ad.

18W LED Tavan ve Duvar Armatürü

IP65



IK03 PP Gövde + PC OPAL Kapak

| Kod | Renk | Fiyat |
|------------|-------|-----------|
| AT10-21801 | 3000K | 28,80 USD |

Aydınlatma Açısı: 100°

IP65 Ø 230 mm X h 78 mm

Gerilim: 220 V
I.Akısı: 595 lm
Gövde: Siyah
Koli M.: 20 Ad.

18W LED Tavan ve Duvar Armatürü

IP65



IK03 PP Gövde + PC OPAL Kapak

| Kod | Renk | Fiyat |
|------------|-------|-----------|
| AT10-31831 | 3000K | 28,80 USD |

Aydınlatma Açısı: 100°

IP65 Ø 230 mm X h 79 mm

Gerilim: 220 V
I.Akısı: 850 lm
Gövde: Siyah
Koli M.: 20 Ad.

18W LED Tavan ve Duvar Armatürü

IP65



IK03 PP Gövde + PC OPAL Kapak

| Kod | Renk | Fiyat |
|------------|-------|-----------|
| AT10-41801 | 3000K | 28,80 USD |

Aydınlatma Açısı: 100°

IP65 Ø 230 mm X h 79 mm

Gerilim: 220 V
I.Akısı: 1020 lm
Gövde: Siyah
Koli M.: 20 Ad.

18W LED Tavan ve Duvar Armatürü

IP65



IK03 PP Gövde + PC OPAL Kapak

| Kod | Renk | Fiyat |
|------------|-------|-----------|
| AT10-51831 | 6500K | 28,80 USD |

Aydınlatma Açısı: 100°

IP65 Ø 230 mm X h 73 mm

Gerilim: 220 V
I.Akısı: 1190 lm
Gövde: Siyah
Koli M.: 20 Ad.

18W LED Tavan ve Duvar Armatürü

IP65



IK03 PP Gövde + PC OPAL Kapak

| Kod | Renk | I.Akısı | Fiyat |
|------------|-------|---------|-----------|
| AT11-11800 | 3000K | 1190 lm | 19,20 USD |
| AT11-11830 | 6500K | 1275 lm | 19,20 USD |

Aydınlatma Açısı: 100°

IP54 190 mm X h 55 mm

Gerilim: 220 V
Gövde: Beyaz
Koli M.: 24 Ad.

18W Radar Sensörlü Sıva Üstü LED Armatür

IP20



Algılama Açısı: 360°

| Kod | Kasa | Fiyat |
|------------|---------|-----------|
| AC16-00134 | Kırmızı | 14,00 USD |
| AC16-00135 | Yeşil | 14,00 USD |
| AC16-00136 | Mavi | 14,00 USD |
| AC16-00137 | Sarı | 14,00 USD |
| AC16-00138 | Turuncu | 14,00 USD |

Gerilim: 220 V
Koli M.: 10 Ad.

I. Isısı: 6500 K

LED Tavan ve Duvar Armatürü

RoHS Compliant | CE | 360° | IP54



| Kod | Renk I. | Güç | Işık Akısı | Ölçü | Koli Mik. | Fiyat |
|------------|---------|------|------------|-----------------|-----------|-----------|
| AT10-00800 | 3000K | 8 W | 600 lm | Ø140 mm x 48 mm | 40 ad. | 9,50 USD |
| AT10-00830 | 6500K | 8 W | 600 lm | Ø140 mm x 48 mm | 40 ad. | 9,50 USD |
| AT10-01200 | 3000K | 12 W | 900 lm | Ø170 mm x 50 mm | 20 ad. | 13,20 USD |
| AT10-01230 | 6500K | 12 W | 900 lm | Ø170 mm x 50 mm | 20 ad. | 13,20 USD |
| AT10-01800 | 3000K | 18 W | 1350 lm | Ø200 mm x 55 mm | 20 ad. | 22,20 USD |
| AT10-01830 | 6500K | 18 W | 1350 lm | Ø200 mm x 55 mm | 20 ad. | 22,20 USD |

Gerilim:
220 V
50-60 Hz

LED Tavan ve Duvar Armatürü

RoHS Compliant | CE | 360° | IP54



| Kod | Renk I. | Güç | Işık Akısı | Ölçü | Koli Mik. | Fiyat |
|------------|---------|------|------------|---------------|-----------|-----------|
| AT11-00800 | 3000K | 8 W | 600 lm | 90x160x51 mm | 32 ad. | 9,50 USD |
| AT11-00830 | 6500K | 8 W | 600 lm | 90x160x51 mm | 32 ad. | 9,50 USD |
| AT11-01200 | 3000K | 12 W | 900 lm | 105x205x54 mm | 32 ad. | 13,20 USD |
| AT11-01230 | 6500K | 12 W | 900 lm | 105x205x54 mm | 32 ad. | 13,20 USD |

Gerilim:
220 V
50-60 Hz

11W LED Tavan ve Duvar Armatürü

IP65



| Kod | Renk | Fiyat |
|------------|-------|-----------|
| AT11-31100 | 3000K | 19,20 USD |
| AT11-31130 | 6500K | 19,20 USD |

IP65 190 mm X 113 mm X h 42 mm
Gerilim: 220 V
I.Akısı: 700 lm
Gövde: Beyaz
Koli M.: 30 Ad.

ABS Gövde + PC OPAL Kapak

15W LED Tavan ve Duvar Armatürü

IP65



| Kod | Renk | Fiyat |
|------------|-------|-----------|
| AT10-11500 | 3000K | 25,80 USD |
| AT10-11530 | 6500K | 25,80 USD |

IP65 Ø 190 mm X h 45 mm
Gerilim: 220 V
I.Akısı: 980 lm
Gövde: Beyaz
Koli M.: 20 Ad.

ABS Gövde + PC OPAL Kapak

15W LED Tavan ve Duvar Armatürü

IP65



| Kod | Renk | Fiyat |
|------------|-------|-----------|
| AT10-21500 | 3000K | 25,80 USD |
| AT10-21530 | 6500K | 25,80 USD |

IP65 190 mm X h 45 mm
Gerilim: 220 V
I.Akısı: 980 lm
Gövde: Beyaz
Koli M.: 20 Ad.

ABS Gövde + PC OPAL Kapak

4W LED Duvar Apliği

IP44



| Kod | Renk | Fiyat |
|------------|-------|-----------|
| AH07-05001 | 3000K | 10,80 USD |
| AH07-05031 | 6500K | 10,80 USD |

IP44 140 mm X h 51 mm
Gerilim: 220 V
I.Akısı: 320 lm
Gövde: Siyah
Koli M.: 40 Ad.

ABS Gövde + PC OPAL Kapak

4W LED Duvar Apliği

IP44



| Kod | Renk | Fiyat |
|------------|-------|-----------|
| AH07-05101 | 3000K | 10,80 USD |

IP44 140 mm X h 52,5 mm
Gerilim: 220 V
I.Akısı: 70 lm
Gövde: Siyah
Koli M.: 40 Ad.

YENİ

4W LED Duvar Apliği

IP44



| Kod | Renk | Fiyat |
|------------|-------|-----------|
| AH07-05201 | 3000K | 10,80 USD |

IP44 Ø140 mm X h 31 mm
Gerilim: 220 V
I.Akısı: 200 lm
Gövde: Siyah
Koli M.: 40 Ad.

YENİ

20W Radar Sensörlü LED Duvar Apliği

IP65

YENİ



| Kod | Renk | Işık Akısı | Fiyat |
|------------|-------|------------|------------------|
| AH07-05530 | 6500K | 1800 lm | 24,00 USD |

Gerilim: 220 V
Gövde: Beyaz
Koli M.: 20 Ad.

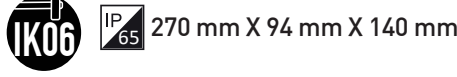

Aydınlatma
Açısı: 120°

20W Sensörlü LED Duvar Apliği

IP44

YENİ



| Kod | Renk | Işık Akısı | Fiyat |
|------------------|-------|------------|------------------|
| Beyaz AH07-05300 | 3000K | 1600 lm | 26,50 USD |
| Gövde AH07-05330 | 6500K | 1800 lm | 26,50 USD |
| Siyah AH07-05431 | 6500K | 1800 lm | 26,50 USD |
| Gövde | | | |

Gerilim: 220 V
Koli M.: 20 Ad.

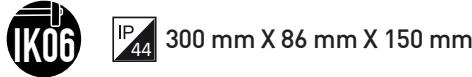

Aydınlatma
Açısı: 120°

LED Mobil Spotlar LED Spotlights

3W Sıva Altı LED Spot Armatür



| Kod | Renk | Fiyat |
|---------------------|-------|-----------------|
| G: Beyaz AH07-01700 | 3000K | 5,85 USD |
| AH07-01710 | 4000K | 5,85 USD |
| AH07-01730 | 6500K | 5,85 USD |
| G: Siyah AH07-01701 | 3000K | 5,85 USD |
| AH07-01711 | 4000K | 5,85 USD |
| AH07-01731 | 6500K | 5,85 USD |

Gerilim : 220 V
Işık Akısı : 210 lm
Kesim Ölçüsü : 30 mm
Koli Miktarı : 100 ad

RoHS Compliant CE 30mm IP20

2,5W Sıva Altı LED Spot Armatür



| Kod | Renk | Fiyat |
|------------|-------|-----------------|
| AH07-01204 | 3000K | 5,10 USD |
| AH07-01234 | 6500K | 5,10 USD |

Gerilim: 220 V
Güç: 2,5W
Gövde Rengi: Saten

Işık Akısı : 210 lm
Kesim Ölçüsü : 55 mm
Koli Miktarı : 100 ad

RoHS Compliant CE 55mm IP20

3W Sıva Altı LED Spot Armatür



| Kod | Renk | Fiyat |
|---------------------|-------|-----------------|
| G: Beyaz AH06-00100 | 3000K | 5,85 USD |
| AH06-00110 | 4000K | 5,85 USD |
| AH06-00130 | 6500K | 5,85 USD |
| G: Siyah AH06-00101 | 3000K | 5,85 USD |
| AH06-00111 | 4000K | 5,85 USD |
| AH06-00131 | 6500K | 5,85 USD |

Gerilim : 220 V
Işık Akısı : 210 lm
Kesim Ölçüsü : 30 mm
Koli Miktarı : 100 ad

RoHS Compliant CE 30mm IP20

3W Sıva Altı LED Spot Armatür



| Kod | Renk | Fiyat |
|---------------------|-------|-----------------|
| G: Beyaz AH06-00300 | 3000K | 5,85 USD |
| AH06-00310 | 4000K | 5,85 USD |
| AH06-00330 | 6500K | 5,85 USD |
| G: Siyah AH06-00301 | 3000K | 5,85 USD |
| AH06-00311 | 4000K | 5,85 USD |
| AH06-00331 | 6500K | 5,85 USD |

Gerilim : 220 V
Işık Akısı : 210 lm
Kesim Ölçüsü : 35 mm
Koli Miktarı : 100 ad

RoHS Compliant CE 35mm IP20

LED Mobil Spotlar

LED Spotlights

3W Sıva Altı LED Spot Armatür



| Kod | Renk | Fiyat |
|------------|-------|----------|
| AH06-00304 | 3000K | 5,40 USD |



| | |
|--------------|----------|
| Gerilim | : 220 V |
| Güç | : 3 W |
| Işık Akısı | : 210 lm |
| Kesim Ölçüsü | : 35 mm |
| Koli Miktarı | : 100 ad |

RoHS Compliant | CE | 35mm | IP20

1W Sıva Altı LED Spot Armatür

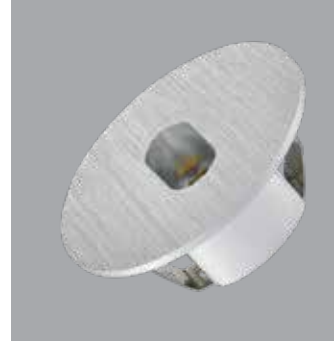

| Kod | Renk | Fiyat |
|------------|-------|-----------|
| AH07-01403 | 3000K | 12,90 USD |

Işık Akısı: 60 lm

| | |
|--------------|----------|
| Gerilim | : 220 V |
| Güç | : 1 W |
| Kesim Ölçüsü | : 40 mm |
| Koli Miktarı | : 100 ad |

RoHS Compliant | CE | 40mm | IP20

3W Sıva Altı LED Spot Armatür



| Kod | Renk | Fiyat |
|------------|-------|----------|
| AH06-00204 | 3000K | 6,60 USD |
| AH06-00234 | 6500K | 6,60 USD |

| | |
|--------------|----------|
| Gerilim | : 220 V |
| Güç | : 3 W |
| Işık Akısı | : 210 lm |
| Kesim Ölçüsü | : 25 mm |
| Koli Miktarı | : 100 ad |

RoHS Compliant | CE | 25mm | IP20

1W Sıva Altı LED Spot Armatür



| Kod | Renk | Fiyat |
|------------|-------|----------|
| AH06-00500 | 3000K | 6,60 USD |
| AH06-00530 | 6500K | 6,60 USD |

| | |
|--------------|----------|
| Gerilim | : 220 V |
| Güç | : 1 W |
| Işık Akısı | : 70 lm |
| Kesim Ölçüsü | : 25 mm |
| Koli Miktarı | : 100 ad |

RoHS Compliant | CE | 25mm | IP20

5W Sıva Üstü LED Spot Armatür



| Kod | Renk | Fiyat |
|------------|-------|-----------|
| AH06-00730 | 6500K | 18,00 USD |

Ölçü: 80 mm x 50 mm x 40 mm

| | |
|--------------|----------|
| Gerilim | : 220 V |
| Güç | : 5 W |
| Işık Akısı | : 350 lm |
| Koli Miktarı | : 50 ad |

RoHS Compliant | CE | IP20

3W Sıva Altı LED Spot Armatür



| Kod | Renk | Fiyat |
|------------|-------|-----------|
| AH05-00403 | 3000K | 12,00 USD |

Işık Akısı: 180 lm

| | |
|--------------|----------|
| Gerilim | : 220 V |
| Güç | : 3 W |
| Kesim Ölçüsü | : 25 mm |
| Koli Miktarı | : 100 ad |

RoHS Compliant | CE | 25mm | IP20

3W Sıva Altı LED Spot Armatür



| Kod | Renk | Fiyat |
|------------|-------|-----------|
| AH05-00503 | 3000K | 12,00 USD |
| AH05-00533 | 6500K | 12,00 USD |

Işık Akısı: 190 lm

| | |
|--------------|----------|
| Gerilim | : 220 V |
| Güç | : 3 W |
| Kesim Ölçüsü | : 25 mm |
| Koli Miktarı | : 100 ad |

RoHS Compliant | CE | 25mm | IP20

3W Sıva Altı LED Spot Armatür



| Kod | Renk | Fiyat |
|------------|-------|-----------|
| AH05-00703 | 3000K | 12,00 USD |

Işık Akısı: 180 lm

| | |
|--------------|----------|
| Gerilim | : 220 V |
| Güç | : 3 W |
| Kesim Ölçüsü | : 25 mm |
| Koli Miktarı | : 100 ad |

RoHS Compliant | CE | 25mm | IP20

LED Mobil Spotlar

LED Spotlights

3W Sıva Altı LED Spot Armatür



| Kod | Renk | Fiyat |
|------------|---------|-----------|
| AH05-00803 | 3000K | 11,80 USD |
| AH05-00833 | 6500K | 11,80 USD |
| AH05-00843 | Kırmızı | 11,80 USD |
| AH05-00853 | Yeşil | 11,80 USD |
| AH05-00863 | Mavi | 11,80 USD |

Işık Akısı: 190 lm

Gerilim : 220 V
Güç : 3 W
Kesim Ölçüsü: 25 mm
Koli Miktarı : 100 ad

RoHS Compliant | CE | 25mm | IP20

3W Sıva Altı LED Spot Armatür



| Kod | Renk | Fiyat |
|------------|-------|-----------|
| AH07-00100 | 3000K | 15,60 USD |
| AH07-00130 | 6500K | 15,60 USD |

Gerilim : 220 V
Güç : 3 W
Işık Akısı : 210 lm
Kesim Ölçüsü : 40 mm
Koli Miktarı : 100 ad

RoHS Compliant | CE | 40mm | IP20

3W Sıva Altı LED Spot Armatür



| Kod | Renk | I. Akısı | Fiyat |
|------------|---------|----------|----------|
| AH07-01334 | 6500K | 210 lm | 8,00 USD |
| AH07-01344 | Kırmızı | 120 lm | 8,00 USD |
| AH07-01354 | Yeşil | 120 lm | 8,00 USD |
| AH07-01364 | Mavi | 90 lm | 8,00 USD |

Gerilim : 220 V
Güç : 3 W
Kesim Ölçüsü: 25 mm
Koli Miktarı : 100 ad

RoHS Compliant | CE | 25mm | IP20

1W Sıva Altı LED Spot Armatür



| Kod | Renk | Fiyat |
|------------|-------|----------|
| AH06-00403 | 3000K | 9,60 USD |
| AH06-00433 | 6500K | 9,60 USD |

Gerilim : 220 V
Güç : 1 W
Işık Akısı : 70 lm
Kesim Ölçüsü : 25 mm
Koli Miktarı : 100 ad

RoHS Compliant | CE | 25mm | IP20

3W Sıva Altı LED Spot Armatür



| Kod | Renk | Fiyat |
|------------|-------|-----------|
| AH06-01200 | 3000K | 10,00 USD |
| AH06-01230 | 6500K | 10,00 USD |

Işık Akısı: 190 lm

Gerilim : 220 V
Güç : 3 W
Kesim Ölçüsü : 35 mm
Koli Miktarı : 100 ad

RoHS Compliant | CE | 35mm | IP20

3W Sıva Altı LED Spot Armatür



| Kod | Renk | Fiyat |
|------------|-------|----------|
| AH06-00936 | 6500K | 6,60 USD |

Işık Akısı: 190 lm

Gerilim : 220 V
Güç : 3 W
Kesim Ölçüsü : 35 mm
Koli Miktarı : 100 ad

RoHS Compliant | CE | 35mm | IP20

Uzaktan Kumandalı Kapı Zilleri

Wireless Remote Control Doorbells

Uzaktan Kumandalı Zil



| Kod | Fiyat |
|------------|-----------|
| AY30-02006 | 12,00 USD |

Koli Miktarı : 60 Ad
Özellikler : 32 Melodili
Algı. Mesafesi : 100 m.

RoHS Compliant | CE | IP20

Uzaktan Kumandalı Zil



| Kod | Fiyat |
|------------|-----------|
| AY30-02019 | 12,00 USD |

Koli Miktarı : 60 Ad
Özellikler : 32 Melodili
Algı. Mesafesi : 100 m.

RoHS Compliant | CE | IP20

Uzaktan Kumandalı Zil



| Kod | Fiyat |
|------------|-----------|
| AY30-02021 | 19,80 USD |

IP65 Buton

Koli Miktarı : 60 Ad
Özellikler : 38 Melodili
Algı. Mesafesi : 100 m.

RoHS Compliant | CE | IP20

Sıva Üstü Dekoratif Armatür

RoHS Compliant CE ISO 9001



| Kod | Gövde | Reflektör | Fiyat | Kod | Gövde | Reflektör | Fiyat |
|------------|-------|-----------|-----------|------------|-------|-----------|-----------|
| AH12-01500 | Beyaz | Beyaz | 11,50 USD | AH12-01501 | Siyah | Beyaz | 11,50 USD |
| AH12-01510 | Beyaz | Siyah | 11,50 USD | AH12-01511 | Siyah | Siyah | 11,50 USD |
| AH12-01560 | Beyaz | Gold | 11,50 USD | AH12-01561 | Siyah | Gold | 11,50 USD |
| AH12-01570 | Beyaz | Orange | 11,50 USD | AH12-01571 | Siyah | Orange | 11,50 USD |

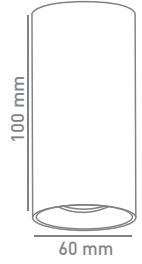

Gerilim: 220 V
Frekans: 50/60 Hz
Duy Tipi: GU10
Koli Miktarı: 50 Ad.

Sıva Üstü Dekoratif Armatür

RoHS Compliant CE ISO 9001



| Kod | Gövde | Reflektör | Fiyat | Kod | Gövde | Reflektör | Fiyat |
|------------|-------|-----------|-----------|------------|-------|-----------|-----------|
| AH12-02500 | Beyaz | Beyaz | 17,25 USD | AH12-02501 | Siyah | Beyaz | 17,25 USD |
| AH12-02510 | Beyaz | Siyah | 17,25 USD | AH12-02511 | Siyah | Siyah | 17,25 USD |
| AH12-02560 | Beyaz | Gold | 17,25 USD | AH12-02561 | Siyah | Gold | 17,25 USD |
| AH12-02570 | Beyaz | Orange | 17,25 USD | AH12-02571 | Siyah | Orange | 17,25 USD |

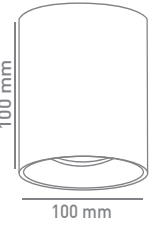

Gerilim: 220 V
Frekans: 50/60 Hz
Duy Tipi: GU10
Koli Miktarı: 50 Ad.

Sıva Üstü Dekoratif Armatür

RoHS Compliant CE ISO 9001

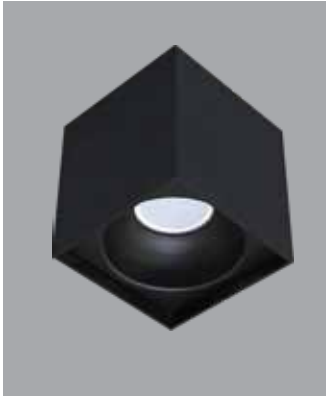

| Kod | Gövde | Reflektör | Fiyat | Kod | Gövde | Reflektör | Fiyat |
|------------|-------|-----------|-----------|------------|-------|-----------|-----------|
| AH12-03500 | Beyaz | Beyaz | 23,00 USD | AH12-03501 | Siyah | Beyaz | 23,00 USD |
| AH12-03510 | Beyaz | Siyah | 23,00 USD | AH12-03511 | Siyah | Siyah | 23,00 USD |
| AH12-03560 | Beyaz | Gold | 23,00 USD | AH12-03561 | Siyah | Gold | 23,00 USD |
| AH12-03570 | Beyaz | Orange | 23,00 USD | AH12-03571 | Siyah | Orange | 23,00 USD |

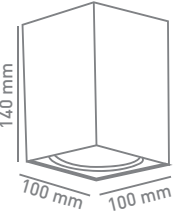

Gerilim: 220 V
Frekans: 50/60 Hz
Duy Tipi: GU10
Koli Miktarı: 50 Ad.

Sıva Üstü Dekoratif Armatür

RoHS Compliant CE ISO 9001



| Kod | Gövde | Reflektör | Fiyat | Kod | Gövde | Reflektör | Fiyat |
|------------|-------|-----------|-----------|------------|-------|-----------|-----------|
| AH12-04500 | Beyaz | Beyaz | 32,50 USD | AH12-04501 | Siyah | Beyaz | 32,50 USD |
| AH12-04510 | Beyaz | Siyah | 32,50 USD | AH12-04511 | Siyah | Siyah | 32,50 USD |
| AH12-04560 | Beyaz | Gold | 32,50 USD | AH12-04561 | Siyah | Gold | 32,50 USD |
| AH12-04570 | Beyaz | Orange | 32,50 USD | AH12-04571 | Siyah | Orange | 32,50 USD |

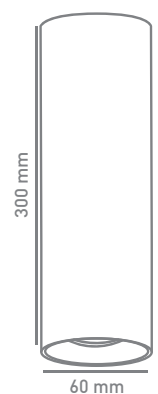

Gerilim: 220 V
Frekans: 50/60 Hz
Duy Tipi: GU10
Koli Miktarı: 50 Ad.

İstenilen boy ve renkte
üretim yapılabilir.

Kumandalar Controllers

4 Yollu IR (Kızıl Ötesi) Kontrol Ünitesi



| Kod | Renk | Fiyat |
|------------|-------|-----------|
| AY30-00170 | Beyaz | 30,00 USD |
| AY30-00180 | Siyah | 30,00 USD |

Ø 98 mm X h 28 mm
Kesim Ölçüsü: 85 mm

AC 110-240 V / 50-60 Hz
Taşıyabileceği Yük:
4 Kanal X 300 W
(Tasarruflu ve LED)
4 Kanal X 1500 W
(Enkandesan)
Koli Miktarı: 50 Ad.

YENİ

RoHS Compliant | CE | IP20

4 Yollu IR (Kızıl Ötesi) Kontrol Ünite Kumandası



| Kod | Renk | Fiyat |
|------------|-------|----------|
| AY30-00190 | Beyaz | 6,00 USD |

2 x 1,5 V, alkalin pil
Koli Miktarı: 100 Ad.

YENİ

RoHS Compliant | CE | IP20

Wi-Fi Akıllı Anahtar



| Kod | Fiyat |
|------------|-----------|
| AY26-01010 | 20,40 USD |

Akım: **10A**
Gerilim: **90 V-230 V**
Güç: **2000W (Max)**
Giriş Gerilimi: **90 V-230 V**
Wireless : **IEEE 802.11 b/g/n**
Çalışma Isısı: **-10°C/+52°C**
İşletim Sis.: **Android / IOS**

Koli Miktarı: 100 Ad.

RoHS Compliant | CE | IP20

Avize Kumandası



| Kod | Tip | Fiyat |
|------------|------|-----------|
| AY30-00110 | 2'li | 13,70 USD |
| AY30-00120 | 3'lü | 16,80 USD |
| AY30-00140 | 4'lü | 18,00 USD |
| AY30-00160 | 6'li | 28,80 USD |

RF Kablosuz Kontrol - Akım Koruma - Kansmaz

Gerilim : 220 V
Güç : 1000 W (Enkandesan)
: 200 W (Tasarruflu)
Koli Miktarı: 50 ad

RoHS Compliant | CE | IP20

RGB Kumandası - RF



| Kod | Fiyat |
|------------|-----------|
| AY30-01120 | 24,00 USD |

Gerilim : 12 V DC
Güç : 288 W
Akım : 18 A
Koli Miktarı : 30 ad

RoHS Compliant | CE | IP20

RGB Kumandası - RF



| Kod | Fiyat |
|------------|-----------|
| AY30-01110 | 21,60 USD |

Gerilim : 12 V DC
Güç : 180 W
Akım : 15 A
Koli Miktarı : 50 ad

RoHS Compliant | CE | IP20

RGB Kumandası - IR



| Kod | Fiyat |
|------------|----------|
| AY30-01130 | 4,20 USD |

Gerilim : 12 V DC
Güç : 96 W
Akım : 6 A
Koli Miktarı : 100 ad

RoHS Compliant | CE | IP20

RGB Sinyal Güçlendirici



| Kod | Fiyat |
|------------|-----------|
| AY30-01010 | 15,00 USD |

Gerilim : 12 V DC
Güç : 144 W
Akım : 12 A
Koli Miktarı : 100 ad

RoHS Compliant | CE | IP20

Şarj edilebilir 30 LED'li Acil Durum Aydınlatması



| Kod | Fiyat |
|------------------------|--------------|
| AC01-00130 | 15,60 USD |
| 205 mm x 65 mm x 36 mm | |
| Gerilim | : 220 V |
| Güç | : 2 W max |
| Akü | : 4 V/2,0 Ah |
| Koli Miktarı | : 20 Ad |

RoHS Compliant | CE | IP20

Şarj edilebilir 60 LED'li Acil Durum Aydınlatması



| Kod | Fiyat |
|------------------------|----------------|
| AC01-00330 | 23,80 USD |
| 360 mm x 65 mm x 36 mm | |
| Gerilim | : 220 V |
| Güç | : 4 W max, |
| Akü | : 2x4 V/2,0 Ah |
| Koli Miktarı | : 20 Ad |

RoHS Compliant | CE | IP20

Şarj edilebilir 90 LED'li Acil Durum Aydınlatması



| Kod | Fiyat |
|------------------------|----------------|
| AC01-00430 | 42,20 USD |
| 500 mm x 65 mm x 36 mm | |
| Gerilim | : 220 V |
| Güç | : 6 W max, |
| Akü | : 2x4 V/2,0 Ah |
| Koli Miktarı | : 15 Ad |

RoHS Compliant | CE | IP20



| Kod | Fiyat |
|--------------|----------------|
| AC04-00134 | 25,00 USD |
| Gerilim | : 220 V |
| Güç | : 8 W max |
| Akü | : 3,7 V/2,0 Ah |
| Koli Miktarı | : 8 Ad |



| Kod | Fiyat |
|--------------|--------------|
| AC02-00430 | 27,50 USD |
| Gerilim | : 220 V |
| Güç | : 4 W max, |
| Akü | : 6 V/4,5 Ah |
| Koli Miktarı | : 10 Ad |

Zaman Saatleri ve Yardımcı Ürünler
Timers and Other Products

W Otomat Tipi Mek. Zaman Saati



| Kod | Fiyat |
|-----------------|-----------|
| AY26-00010 | 16,50 USD |
| Rezervli | |
| Koli Miktarı | 100 ad |

RoHS Compliant | CE | IP20

Priz Tipi Mekanik Zaman Saati



| Kod | Fiyat |
|--------------|----------|
| AY26-00020 | 9,80 USD |
| Koli Miktarı | 48 ad |

RoHS Compliant | CE | IP20

GZ10 Seramik duy



| Kod | Fiyat |
|--------------|----------|
| AY25-00110 | 0,55 USD |
| Koli Miktarı | 1000 ad |

RoHS Compliant | CE | IP20

PVC Elektrik İzolasyon Bandı



| Kod | Renk | Fiyat |
|------------|---------|----------|
| AY90-00100 | Beyaz | 0,60 USD |
| AY90-00101 | Siyah | 0,60 USD |
| AY90-00102 | Gri | 0,60 USD |
| AY90-00104 | Kırmızı | 0,60 USD |
| AY90-00105 | Yeşil | 0,60 USD |
| AY90-00106 | Mavi | 0,60 USD |
| AY90-00107 | Sarı | 0,60 USD |

Boyut: 0,13 mmX19 mmX10 mm / Koli Miktarı: 500 ad

LED Yönlendirme Levhaları

LED Emergency Signs

LED İşaretleme Tabelaları



| Kod | Fiyat |
|--------------|---|
| AC14-01000 | 24,15 USD |
| Gerilim | : 220 V |
| Güç | : 1 W |
| Koli Miktarı | : 20 ad |
| Özellikler | : LED Ampullü, şarj edilebilir, 3 saat yanma süresi, çift yönlü. |

Dikkat: Kutu içeriğinde yönlendirme çıkartması bulunmamaktadır!
İhtiyacınız olan çıkartmayı lütfen sipariş sırasında bildiriniz.

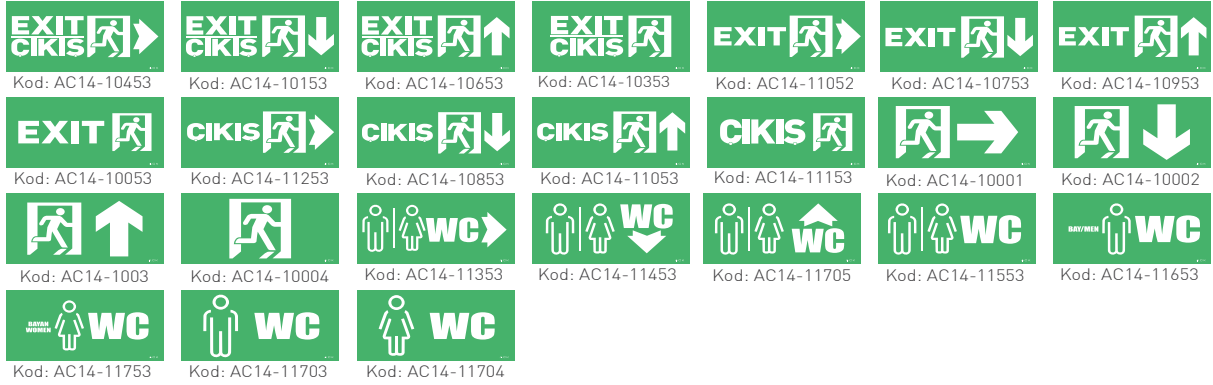

LED İşaretleme Tabelaları



| Kod | Fiyat |
|--------------|--|
| Tüm Kodlar | 12,70 USD |
| Gerilim | : 220 V |
| Güç | : 1 W |
| Koli Miktarı | : 20 ad |
| Özellikler | : LED Ampullü, şarj edilebilir, 3 saat yanma süresi, çift yönlü. |

LED Lambalı Armatürler İçin Bataryalı Yedekleme Üniteleri



| Kod | Lamba | Süre | Batarya | Ağırlık | Güç | Boyutlar | Fiyat |
|------------|----------------|----------|----------------|---------|-------|---------------------------|-----------|
| AC15-61312 | 12V LED Lamba | 60 dak. | 3 cell AA size | 0,28 kg | 1,5 W | 17,5 cm x 3,3 cm x 2,5 cm | 38,50 USD |
| AC15-63312 | 12V LED Lamba | 180 dak. | 3 cell SC size | 0,38 kg | 1,5 W | 17,5 cm x 3,3 cm x 2,5 cm | 44,00 USD |
| AC15-61609 | 220V LED Lamba | 60 dak. | 5 cell SC size | 0,45 kg | 3,5 W | 23,8 cm x 3,5 cm x 2,8 cm | 55,00 USD |
| AC15-62609 | 220V LED Lamba | 120 dak. | 3 cell D size | 0,75 kg | 3,5 W | 23,8 cm x 3,5 cm x 2,8 cm | 74,00 USD |

Gerilim : 220-240 V
Yanma Durumu : Kesintide yanan
Kullanım Tipi : Dahili
IP : 30



LED Lambalı Armatürler İçin Acil Durum Kiti



| Kod | Fiyat |
|--------------|--------------------------|
| AC15-00609 | 13,80 USD |
| Giriş | : AC 85-265V / 50-60 Hz |
| Çıkış | : 3W |
| Batarya | : Lithium 3,7 V 2200 mAh |
| Koli Miktarı | : 50 ad. |
| Özellikler | : 2 Saat çalışma süresi/ |

LED Ampul pazarında yılların tecrübesi ve bilgi birikimi; yüksek teknolojlü ampul üretim hattlarıyla buluştu. Tüm komponentleri Ar-Ge departmanımız tarafından belirlenmiş olan LED Ampullerimizde, yüksek verimli, kaliteli ham ve ara mamüller kullanmaya özen gösteriyoruz. ACK Ampuller, bu özen ve birikim sayesinde yıllara meydan okuyan bir aydınlatma verimliliği sunuyor.



Teknik Özellikler

| Ürün Kodu | Modeli | Işık Akısı | Güç | Enerji S. | Renk Isısı | Duy Tipi | Akım | A. Açısı | PF |
|------------|--------|------------|------|-----------|------------|----------|--------|----------|-----|
| AA09-00510 | C37 | 375 lm | 5 W | A+ | 3000K | E14 | 22 mA | 200 | 0,5 |
| AA09-00511 | C37 | 400 lm | 5 W | A+ | 4000K | E14 | 22 mA | 200 | 0,5 |
| AA09-00513 | C37 | 450 lm | 5 W | A+ | 6500K | E14 | 22 mA | 200 | 0,5 |
| AA09-00710 | C37 | 575 lm | 7 W | A+ | 3000K | E14 | 32 mA | 200 | 0,5 |
| AA09-00711 | C37 | 600 lm | 7 W | A+ | 4000K | E14 | 32 mA | 200 | 0,5 |
| AA09-00713 | C37 | 630 lm | 7 W | A+ | 6500K | E14 | 32 mA | 200 | 0,5 |
| AA11-00510 | P45 | 480 lm | 5 W | A+ | 3000K | E14 | 22 mA | 200 | 0,5 |
| AA11-00511 | P45 | 485 lm | 5 W | A+ | 4000K | E14 | 22 mA | 200 | 0,5 |
| AA11-00513 | P45 | 490 lm | 5 W | A+ | 6500K | E14 | 22 mA | 200 | 0,5 |
| AA11-00520 | G45 | 480 lm | 5 W | A+ | 3000K | E27 | 22 mA | 200 | 0,5 |
| AA11-00521 | G45 | 485 lm | 5 W | A+ | 4000K | E27 | 22 mA | 200 | 0,5 |
| AA11-00523 | G45 | 490 lm | 5 W | A+ | 6500K | E27 | 22 mA | 200 | 0,5 |
| AA13-00920 | A60-9 | 800 lm | 9 W | A+ | 3000K | E27 | 39 mA | 200 | 0,5 |
| AA13-00921 | A60-9 | 840 lm | 9 W | A+ | 4000K | E27 | 39 mA | 200 | 0,5 |
| AA13-00923 | A60-9 | 880 lm | 9 W | A+ | 6500K | E27 | 39 mA | 200 | 0,5 |
| AA13-01220 | A60-12 | 1,075 lm | 12 W | A+ | 3000K | E27 | 54 mA | 200 | 0,5 |
| AA13-01221 | A60-12 | 1,120 lm | 12 W | A+ | 4000K | E27 | 54 mA | 200 | 0,5 |
| AA13-01223 | A60-12 | 1,170 lm | 12 W | A+ | 6500K | E27 | 54 mA | 200 | 0,5 |
| AA13-01520 | A70 | 1,350 lm | 15 W | A+ | 3000K | E27 | 68 mA | 200 | 0,5 |
| AA13-01521 | A70 | 1,400 lm | 15 W | A+ | 4000K | E27 | 68 mA | 200 | 0,5 |
| AA13-01523 | A70 | 1,450 lm | 15 W | A+ | 6500K | E27 | 68 mA | 200 | 0,5 |
| AA13-02020 | T80 | 1,750 lm | 20 W | A+ | 3000K | E27 | 91 mA | 200 | 0,5 |
| AA13-02023 | T80 | 1,800 lm | 20 W | A+ | 6500K | E27 | 91 mA | 200 | 0,5 |
| AA13-03020 | T100 | 2,650 lm | 30 W | A+ | 3000K | E27 | 136 mA | 200 | 0,9 |
| AA13-03023 | T100 | 2,7000 lm | 30 W | A+ | 6500K | E27 | 136 mA | 200 | 0,9 |
| AA13-04020 | T120 | 3,500 lm | 40 W | A+ | 3000K | E27 | 182 mA | 200 | 0,9 |
| AA13-04023 | T120 | 3,600 lm | 40 W | A+ | 6500K | E27 | 182 mA | 200 | 0,9 |
| AA13-05020 | T135 | 4,400 lm | 50 W | A+ | 3000K | E27 | 227 mA | 200 | 0,9 |
| AA13-05023 | T135 | 4,500 lm | 50 W | A+ | 6500K | E27 | 227 mA | 200 | 0,9 |
| AA24-00550 | GU10 | 400 lm | 5 W | A++ | 3000K | GU10 | 22 mA | 120 | 0,5 |
| AA24-00553 | GU10 | 450 lm | 5 W | A+ | 6500K | GU10 | 22 mA | 120 | 0,5 |
| AA24-00750 | GU10 | 600 lm | 7 W | A+ | 3000K | GU10 | 32 mA | 120 | 0,5 |
| AA24-00753 | GU10 | 630 lm | 7 W | A+ | 6500K | GU10 | 32 mA | 120 | 0,5 |

Yüksek geçirgenlikli
PC reflektör

LED Ampullerimizin üretiminde
yüksek kaliteli komponentler kullanıyor ve
teknolojik gelişmeleri yakından izliyoruz.



Yüksek kaliteli
sürücü

Alüminyum Duy

Süper Parlak
SAMSUNG SMD2835 çip

PBT Plastik kaplama
alüminyum soğutucu



LED Ampuller

LED Lamps

LED Mum Ampul

RoHS Compliant | CE | ISO 9001 | 20.000 hr



| Kod | Güç | Renk | I.Akısı | Duy | Koli Mik. | Fiyat |
|------------|-----|-------|---------|-----|-----------|----------|
| AA09-00510 | 5W | 3000K | 375 lm | E14 | 100 ad. | 2,20 USD |
| AA09-00511 | 5W | 4000K | 400 lm | E14 | 100 ad. | 2,20 USD |
| AA09-00513 | 5W | 6500K | 450 lm | E14 | 100 ad. | 2,20 USD |
| AA09-00710 | 7W | 3000K | 525 lm | E14 | 100 ad. | 2,50 USD |
| AA09-00711 | 7W | 4000K | 540 lm | E14 | 100 ad. | 2,50 USD |
| AA09-00713 | 7W | 6500K | 560 lm | E14 | 100 ad. | 2,50 USD |

Gerilim: 220 V - Frekans: 50/60 Hz

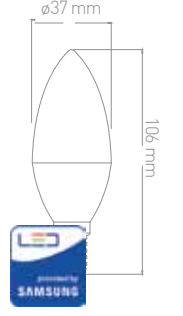

LED Top Ampul

RoHS Compliant | CE | ISO 9001 | 20.000 hr



| Kod | Güç | Renk | I.Akısı | Duy | Koli Mik. | Fiyat |
|------------|-----|-------|---------|-----|-----------|----------|
| AA11-00510 | 5 W | 3000K | 480 lm | E14 | 100 ad. | 2,20 USD |
| AA11-00511 | 5 W | 4000K | 485 lm | E14 | 100 ad. | 2,20 USD |
| AA11-00513 | 5 W | 6500K | 490 lm | E14 | 100 ad. | 2,20 USD |
| AA11-00520 | 5 W | 3000K | 480 lm | E27 | 100 ad. | 2,20 USD |
| AA11-00521 | 5 W | 4000K | 485 lm | E27 | 100 ad. | 2,20 USD |
| AA11-00523 | 5 W | 6500K | 490 lm | E27 | 100 ad. | 2,20 USD |

Gerilim: 220 V - Frekans: 50/60 Hz

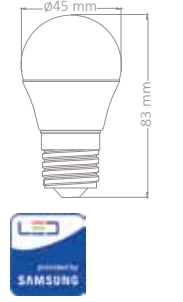

LED A60 Ampul

RoHS Compliant | CE | ISO 9001 | 20.000 hr



| Kod | Güç | Renk | I.Akısı | Duy | Koli Mik. | Fiyat |
|------------|-----|-------|---------|-----|-----------|----------|
| AA13-00920 | 9W | 3000K | 800 lm | E27 | 100 ad. | 2,15 USD |
| AA13-00921 | 9W | 4000K | 840 lm | E27 | 100 ad. | 2,15 USD |
| AA13-00923 | 9W | 6500K | 880 lm | E27 | 100 ad. | 2,15 USD |

Gerilim: 220 V
Frekans: 50/60 Hz



LED A60 Ampul

RoHS Compliant | CE | ISO 9001 | 20.000 hr



| Kod | Güç | Renk | I.Akısı | Duy | Koli Mik. | Fiyat |
|------------|-----|-------|---------|-----|-----------|----------|
| AA13-01220 | 12W | 3000K | 1075 lm | E27 | 100 ad. | 2,80 USD |
| AA13-01221 | 12W | 4000K | 1120 lm | E27 | 100 ad. | 2,80 USD |
| AA13-01223 | 12W | 6500K | 1170 lm | E27 | 100 ad. | 2,80 USD |

Gerilim: 220 V
Frekans: 50/60 Hz



LED A70 Ampul

RoHS Compliant | CE | ISO 9001 | 20.000 hr



| Kod | Güç | Renk | I.Akısı | Duy | Koli Mik. | Fiyat |
|------------|-----|-------|---------|-----|-----------|----------|
| AA13-01520 | 15W | 3000K | 1350 lm | E27 | 100 ad. | 3,45 USD |
| AA13-01521 | 15W | 4000K | 1400 lm | E27 | 100 ad. | 3,45 USD |
| AA13-01523 | 15W | 6500K | 1450 lm | E27 | 100 ad. | 3,45 USD |

Gerilim: 220 V
Frekans: 50/60 Hz



LED Ampuller

LED Lamps

ACK

LED T80-T100-T120-T135-T1360 Ampul

RoHS Compliant | CE | ISO 9001 | 20.000 hr



Gerilim: 220 V
Frekans: 50/60 Hz

| Kod | Tipi | Güç | Renk | I.Akısı | Duy Tipi | Koli A. | Fiyat |
|------------|------|-----|-------|---------|----------|---------|-----------|
| AA13-02020 | T80 | 20W | 3000K | 1750 lm | E27 | 50 ad. | 5,60 USD |
| AA13-02023 | T80 | 20W | 6500K | 1800 lm | E27 | 50 ad. | 5,60 USD |
| AA13-03020 | T100 | 30W | 3000K | 2650 lm | E27 | 30 ad. | 10,80 USD |
| AA13-03023 | T100 | 30W | 6500K | 2700 lm | E27 | 30 ad. | 10,80 USD |
| AA13-04020 | T120 | 40W | 3000K | 3500 lm | E27 | 30 ad. | 14,40 USD |
| AA13-04023 | T120 | 40W | 6500K | 3600 lm | E27 | 30 ad. | 14,40 USD |
| AA13-05020 | T135 | 50W | 3000K | 4400 lm | E27 | 20 ad. | 19,20 USD |
| AA13-05023 | T135 | 50W | 6500K | 4500 lm | E27 | 20 ad. | 19,20 USD |
| AA13-06020 | T160 | 60W | 3000K | 5300 lm | E27 | 20 ad. | 25,20 USD |
| AA13-06023 | T160 | 60W | 6500K | 5400 lm | E27 | 20 ad. | 25,20 USD |

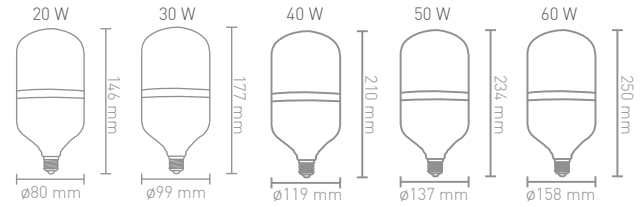

12-48 V / 9 W SMD LED Ampul

RoHS Compliant | CE | ISO 9001 | 20.000 hr



| Kod | Güç | Renk | I.Akısı | Duy | Koli Mik. | Fiyat |
|------------|-----|-------|---------|-----|-----------|----------|
| AA14-20920 | 9W | 3000K | 800 lm | E27 | 100 ad. | 4,40 USD |
| AA14-20921 | 9W | 4000K | 840 lm | E27 | 100 ad. | 4,40 USD |
| AA14-20923 | 9W | 6500K | 880 lm | E27 | 100 ad. | 4,40 USD |



Gerilim: AC/DC 12-48 V

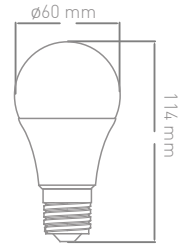

9 W Dimlenebilir LED A60 Ampul

RoHS Compliant | CE | ISO 9001 | 20.000 hr



| Kod | Güç | Renk | I.Akısı | Duy | Koli Mik. | Fiyat |
|------------|-----|-------|---------|-----|-----------|----------|
| AA14-01020 | 9W | 3000K | 900 lm | E27 | 100 ad. | 5,40 USD |
| AA14-01023 | 9W | 6500K | 900 lm | E27 | 100 ad. | 5,40 USD |

Gerilim: 220 V
Frekans: 50/60 Hz

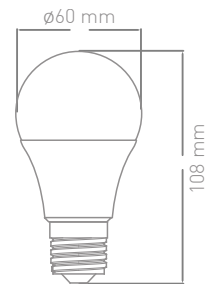

14 W COB PAR-30 Spot Ampul

RoHS Compliant | CE | 20.000 hr



| Kod | Renk | Fiyat |
|------------|-------|-----------|
| AA31-81420 | 3000K | 12,00 USD |

Gerilim: 220 V - 50/60 Hz
Duy: E27
I.Akısı: 950 lm
Koli Mik: 40 ad.

5 W SMD LED Ampul

RoHS Compliant | CE | 20.000 hr



| Kod | Renk | Fiyat |
|------------|-------|----------|
| AA24-00560 | 3000K | 2,90 USD |
| AA24-00563 | 6500K | 2,90 USD |

Gerilim: 220 V - 50/60 Hz
Duy: G5.3
I.Akısı: 425 lm
Koli Mik: 100 ad.

LED Ampuller

LED Lamps

GU10 Difizörlü LED Ampul



ISO 9001

20.000 hr



| Kod | Güç | Renk | I.Akısı | Duy | Koli Mik. | Fiyat |
|------------|-----|-------|---------|------|-----------|----------|
| AA24-00750 | 7W | 3000K | 600 lm | GU10 | 100 ad. | 2,76 USD |
| AA24-00751 | 7W | 4000K | 610 lm | GU10 | 100 ad. | 2,76 USD |
| AA24-00753 | 7W | 6500K | 630 lm | GU10 | 100 ad. | 2,76 USD |

Gerilim: 220 V Frekans: 50/60 Hz

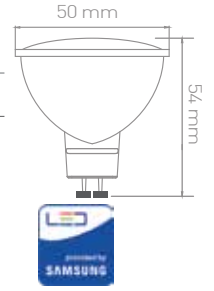

GU10 Reflektörlü LED Ampul



ISO 9001

20.000 hr



| Kod | Güç | Renk | I.Akısı | Duy | Koli Mik. | Fiyat |
|------------|-----|-------|---------|------|-----------|----------|
| AA24-01550 | 5W | 3000K | 400 lm | GU10 | 100 ad. | 2,70 USD |
| AA24-01553 | 5W | 6500K | 450 lm | GU10 | 100 ad. | 2,70 USD |
| AA24-01555 | 5W | Yeşil | - | GU10 | 100 ad. | 2,70 USD |
| AA24-01558 | 5W | Amber | - | GU10 | 100 ad. | 2,70 USD |

Gerilim: 220 V Frekans: 50/60 Hz

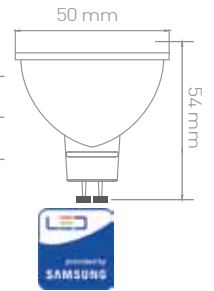

LED Kapsül Ampuller

LED Capsule Lamps

2,2 W LED Kapsül Ampul



ISO 9001

15.000 hr



| Kod | Renk | Fiyat |
|------------|-------|----------|
| AA29-00390 | 3000K | 3,20 USD |
| AA29-00393 | 6500K | 3,20 USD |

11 mm x 48 mm x 16,5 mm

Gerilim: 220 V - 50/60 Hz

Duy: G9

I.Akısı: 185 lm

Koli Mik: 500 ad.

1,6 W LED Kapsül Ampul



ISO 9001

15.000 hr



| Kod | Renk | Fiyat |
|------------|-------|----------|
| AA29-30340 | 3000K | 2,50 USD |
| AA29-30343 | 6500K | 2,50 USD |

42 mm x 15,6 mm x 15,6 mm

Gerilim: 220 V - 50/60 Hz

Duy: G4

I.Akısı: 130 lm

Koli Mik: 500 ad.

Gerilim: AC/DC 12 V

2,3 W LED Kapsül Ampul



ISO 9001

15.000 hr



| Kod | Renk | Fiyat |
|------------|-------|----------|
| AA29-30440 | 3000K | 3,60 USD |
| AA29-30443 | 6500K | 3,60 USD |

11 mm x 48 mm x 16,5 mm

Gerilim: AC/DC 12 V

Duy: G4

I.Akısı: 185 lm

Koli Mik: 500 ad.

Gerilim: AC/DC 12 V

2,3 W LED Kapsül Ampul



ISO 9001

15.000 hr



| Kod | Renk | Fiyat |
|------------|-------|----------|
| AA29-00440 | 3000K | 3,60 USD |

42 mm x 15,6 mm x 15,6 mm

Gerilim: 220 V - 50/60 Hz

Duy: G4

I.Akısı: 270 lm

Koli Mik: 500 ad.

3,2 W LED Kapsül Ampul



ISO 9001

15.000 hr



| Kod | Renk | Fiyat |
|------------|-------|----------|
| AA29-00410 | 3000K | 4,80 USD |
| AA29-00413 | 6500K | 4,80 USD |

54 mm x 15,6 mm x 15,6 mm

Gerilim: 220 V - 50/60 Hz

Duy: E14

I.Akısı: 300 lm

Koli Mik: 500 ad.

1 W LED Kapsül Ampul



ISO 9001

15.000 hr



| Kod | Renk | Fiyat |
|------------|-------|----------|
| AA29-00140 | 3000K | 4,80 USD |

9,5 mm x 9,5 mm x 36,9 mm

Gerilim: 220 V - 50/60 Hz

Duy: G4

I.Akısı: 100 lm

Koli Mik: 500 ad.

LED Rustik Ampuller

LED Rustic Lamps

ACK

6W Rustik LED Ampul (A60)



| Kod | Fiyat |
|------------|----------|
| AA38-00620 | 4,50 USD |

Renk:3000K

Gerilim : 220 V
Güç : 6 W
Işık Akısı : 600 lm
Duy Tipi : E27
Koli Miktarı : 100 ad

RoHS Compliant | CE | ISO 9001

Rustik LED Ampul (C35)



| Kod | Güç | Işık Akısı | Fiyat |
|------------|-----|------------|----------|
| AA36-00410 | 4 W | 440 lm | 3,35 USD |
| AA36-00610 | 6 W | 660 lm | 3,90 USD |

Renk:3000K

Gerilim : 220 V
Duy Tipi : E14
Koli Miktarı : 100 ad

RoHS Compliant | CE | ISO 9001

4W Rustik LED Ampul (G125)



| Kod | Fiyat |
|------------|-----------|
| AB48-00420 | 10,00 USD |

Renk:2200K

Gerilim : 220 V
Güç : 4 W
Işık Akısı : 350 lm
Duy Tipi : E27
Koli Miktarı : 20 ad

Uzun Filaman

RoHS Compliant | CE | ISO 9001

4W Rustik LED Ampul (G95)



| Kod | Fiyat |
|------------|----------|
| AB47-00420 | 7,80 USD |

Renk:2200K

Gerilim : 220 V
Güç : 4 W
Işık Akısı : 350 lm
Duy Tipi : E27
Koli Miktarı : 50 ad

RoHS Compliant | CE | ISO 9001

4W Rustik LED Ampul (ST64)



| Kod | Fiyat |
|------------|----------|
| AB46-00420 | 5,50 USD |

Renk:2200K

Gerilim : 220 V
Güç : 4 W
Işık Akısı : 350 lm
Duy Tipi : E27
Koli Miktarı : 50 ad

Uzun Filaman

RoHS Compliant | CE | ISO 9001

4W Rustik LED Ampul (G95)



| Kod | Fiyat |
|------------|-----------|
| AB55-00420 | 10,00 USD |

Renk:2200K

Gerilim : 220 V
Güç : 4 W
Işık Akısı : 350 lm
Duy Tipi : E27
Koli Miktarı : 20 ad

RoHS Compliant | CE | ISO 9001

4W Rustik LED Piramit Ampul



| Kod | Fiyat |
|------------|-----------|
| AB53-00420 | 11,00 USD |

Renk:2200K

Gerilim : 220 V
Güç : 4 W
Işık Akısı : 350 lm
Duy Tipi : E27
Koli Miktarı : 20 ad

Uzun Filaman

RoHS Compliant | CE | ISO 9001

4W Rustik LED Prizmatik Ampul



| Kod | Fiyat |
|------------|-----------|
| AB50-00420 | 11,00 USD |

Renk:2200K

Gerilim : 220 V
Güç : 4 W
Işık Akısı : 350 lm
Duy Tipi : E27
Koli Miktarı : 20 ad

Uzun Filaman

RoHS Compliant | CE | ISO 9001

LED Rustik Ampuller

LED Rustic Lamps

4W Rustik LED Ampul (G125)



Uzun Filaman

| Kod | Fiyat |
|------------|-----------|
| AB59-00420 | 13,20 USD |

Renk:2200K

| | |
|--------------|----------|
| Gerilim | : 220 V |
| Güç | : 4 W |
| Işık Akısı | : 350 lm |
| Duy Tipi | : E27 |
| Koli Miktarı | : 20 ad |

RoHS Compliant | CE | ISO 9001

4W Rustik LED Ampul (G95)



Uzun Filaman

| Kod | Fiyat |
|------------|-----------|
| AB56-00420 | 10,00 USD |

Renk:2200K

| | |
|--------------|----------|
| Gerilim | : 220 V |
| Güç | : 4 W |
| Işık Akısı | : 350 lm |
| Duy Tipi | : E27 |
| Koli Miktarı | : 20 ad |

RoHS Compliant | CE | ISO 9001

4W Rustik LED Ampul (G125)



Uzun Filaman

| Kod | Fiyat |
|------------|-----------|
| AB58-00420 | 13,20 USD |

Renk:2200K

| | |
|--------------|----------|
| Gerilim | : 220 V |
| Güç | : 4 W |
| Işık Akısı | : 350 lm |
| Duy Tipi | : E27 |
| Koli Miktarı | : 20 ad |

RoHS Compliant | CE | ISO 9001

4W Rustik LED Ampul (G100)



Uzun Filaman

| Kod | Fiyat |
|------------|-----------|
| AB57-00420 | 10,00 USD |

Renk:2200K

| | |
|--------------|----------|
| Gerilim | : 220 V |
| Güç | : 4 W |
| Işık Akısı | : 350 lm |
| Duy Tipi | : E27 |
| Koli Miktarı | : 20 ad |

RoHS Compliant | CE | ISO 9001

Wi-Fi Akıllı LED Ampuller

Wif-Fi Smart LED Bulbs

| Kod | Fiyat |
|------------|-----------|
| AA14-60920 | 17,20 USD |

Renk Işısj: 16 Milyon Renk

Gerilim: 220 V / 50/60 Hz
Güç: 10 W
I. Akısı: 800 lm (6500K için)
Duy: E27
Koli Mik: 100 Ad.

Ürünün özelliklerinden yararlanabilmeniz için Smart Life uygulamasını AppStore / Google Playstore üzerinden telefon veya tabletinize indirmanız gerekmektedir..



Download on the App Store
GET IT ON Google Play
QR Kodunu tarayarak "Smart Life" uygulamasını telefonunuza kurun.
Scan QR code to download the App "Smart Life"



RoHS Compliant | CE | ISO 9001 | 20,000 hr

YERLİ ÜRETİM

Hey Siri | Google Assistant | Google Home | Amazon Alexa

LED Tüp Ampuller

LED Tubes

Dekoratif LED Tüp Ampüller



ISO 9001

30.000 hr



18 W LED Tüp

| Kod | Renk | I.Akısı | Fiyat |
|------------|---------|---------|----------|
| AA52-01280 | 3000K | 1440 lm | 7,00 USD |
| AA52-01281 | 4000K | 1440 lm | 7,00 USD |
| AA52-01283 | 6500K | 1440 lm | 7,00 USD |
| AA52-01284 | Kırmızı | - | 8,00 USD |
| AA52-01285 | Yeşil | - | 8,00 USD |
| AA52-01286 | Mavi | - | 8,00 USD |

Boy: 1200 mm

Gerilim : 220 V
Güç : 18 W
Duy Tipi : G13
Koli Miktarı : 25 ad

9 W LED Tüp

| Kod | Renk | I.Akısı | Fiyat |
|------------|-------|---------|----------|
| AA52-00680 | 3000K | 720 lm | 5,30 USD |
| AA52-00681 | 4000K | 720 lm | 5,30 USD |
| AA52-00683 | 6500K | 720 lm | 5,30 USD |

Boy: 600 mm

Gerilim : 220 V
Güç : 9 W
Duy Tipi : G13
Koli Miktarı : 25 ad

Dekoratif LED Sarkıtlar

Decorative LED Pendants

Dekoratif LED Sarkıt Ampülleri



ISO 9001

30.000 hr



Askı aparatı
ayrı satılmaktadır.

24 W Renkli Dekoratif LED Sarkıt Ampul

| Kod | Gövde | I.Isısı | Fiyat |
|------------|-------|---------|-----------|
| AB01-02420 | Beyaz | 3000K | 12,50 USD |
| AB01-12420 | Siyah | 3000K | 12,50 USD |
| AB01-12423 | Siyah | 6500K | 12,50 USD |
| AB01-52420 | Yeşil | 3000K | 12,50 USD |
| AB01-62420 | Mavi | 3000K | 12,50 USD |

Gerilim : 220 V
Güç : 24 W
Işık Akısı : 1920 lm
Boyutları : 150 mm x 88 mm
Koli Miktarı : 8 ad

32 W Renkli Dekoratif LED Sarkıt Ampülü

| Kod | Gövde | I.Isısı | Fiyat |
|------------|---------|---------|-----------|
| AB01-43220 | Kırmızı | 3000K | 17,00 USD |
| AB01-53220 | Yeşil | 3000K | 17,00 USD |
| AB01-53223 | Yeşil | 6500K | 17,00 USD |
| AB01-63220 | Mavi | 3000K | 17,00 USD |
| AB01-63223 | Mavi | 6500K | 17,00 USD |

Gerilim : 220 V
Güç : 32 W
Işık Akısı : 2560 lm
Boyutları : 220 mm x 125 mm
Koli Miktarı : 8 ad

Renkli Dekoratif LED Sarkıt Askı Aparatları

| Kod | Gövde | Fiyat |
|------------|------------|----------|
| AY45-00100 | Beyaz | 5,90 USD |
| AY45-00101 | Siyah | 5,90 USD |
| AY45-00200 | Kahverengi | 6,50 USD |

Koli Miktarı : 100 ad



LED Barlar

LED Bars

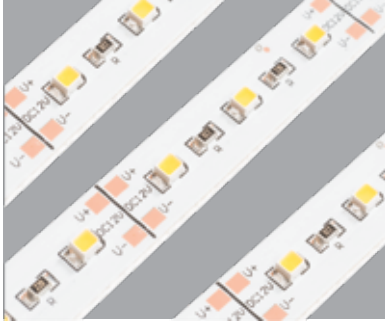

LED Barlar



| Kod | Renk | Fiyat |
|------------|-------|----------|
| AS05-00100 | 3000K | 4,40 USD |
| AS05-00101 | 4000K | 4,40 USD |
| AS05-00103 | 6500K | 4,40 USD |
| AS05-00106 | Mavi | 5,00 USD |

Gerilim : 12 V
Güç : 18 W/mt
Işık Akısı : 125 lm/W
Koli Miktarı: 100 ad



IP20

OSRAM LED kullanılmıştır Farklı renk seçenekleri için fiyat sorunuz.

12 V - 24 V - Sıva Üstü LED Barlar

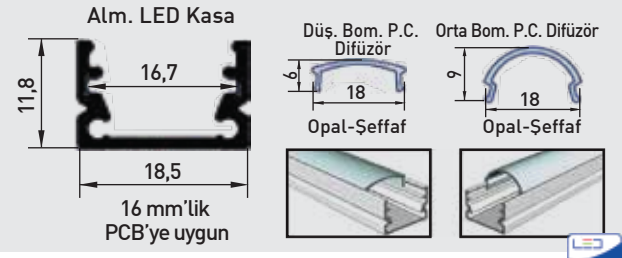
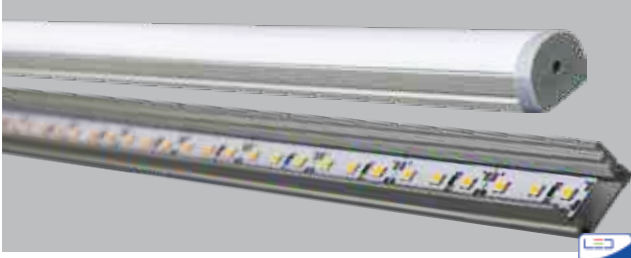

12 V

OSRAM LED

| Kod | Renk | Kesit | Güç | Işık Akısı | Fiyat |
|------------|-------|---------|---------|------------|-----------|
| AS10-01203 | 3000K | 16,5 mm | 14 W/mt | 950 lm/mt | 11,00 USD |
| AS10-01213 | 4000K | 16,5 mm | 14 W/mt | 1000 lm/mt | 11,00 USD |
| AS10-01233 | 6500K | 16,5 mm | 14 W/mt | 1050 lm/mt | 11,00 USD |

24 V

OSRAM LED

| Kod | Renk | Kesit | Güç | Işık Akısı | Fiyat |
|------------|-------|---------|---------|------------|-----------|
| AS10-02403 | 3000K | 16,5 mm | 14 W/mt | 1050 lm/mt | 11,50 USD |
| AS10-02413 | 4000K | 16,5 mm | 14 W/mt | 1100 lm/mt | 11,50 USD |
| AS10-02433 | 6500K | 16,5 mm | 14 W/mt | 1150 lm/mt | 11,50 USD |

12 V - 24 V - Sıva Altı LED Barlar

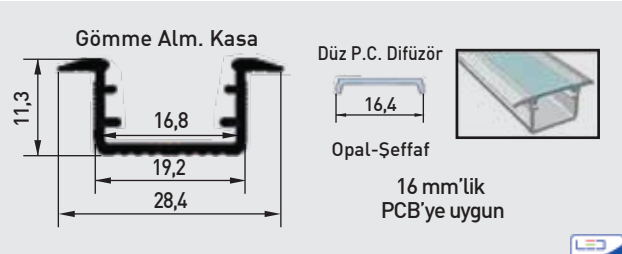
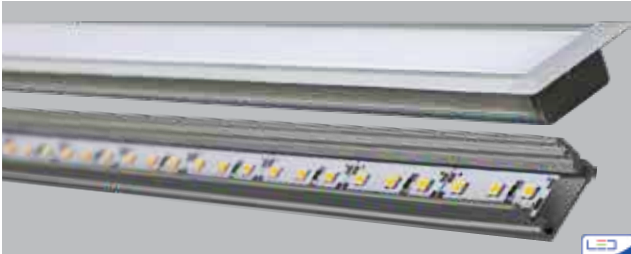

12 V

OSRAM LED

| Kod | Renk | Kesit | Güç | Işık Akısı | Fiyat |
|------------|-------|---------|---------|------------|-----------|
| AS11-01203 | 3000K | 16,5 mm | 14 W/mt | 950 lm/mt | 12,00 USD |
| AS11-01213 | 4000K | 16,5 mm | 14 W/mt | 1000 lm/mt | 12,00 USD |
| AS11-01233 | 6500K | 16,5 mm | 14 W/mt | 1050 lm/mt | 12,00 USD |

24 V

OSRAM LED

| Kod | Renk | Kesit | Güç | Işık Akısı | Fiyat |
|------------|-------|---------|---------|------------|-----------|
| AS11-02403 | 3000K | 16,5 mm | 14 W/mt | 1050 lm/mt | 12,65 USD |
| AS11-02413 | 4000K | 16,5 mm | 14 W/mt | 1100 lm/mt | 12,65 USD |
| AS11-02433 | 6500K | 16,5 mm | 14 W/mt | 1150 lm/mt | 12,65 USD |

12 V - Sıva Üstü LED Barlar

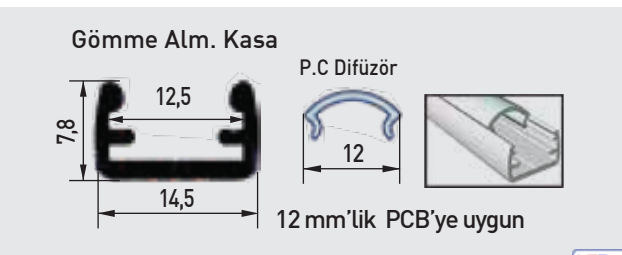
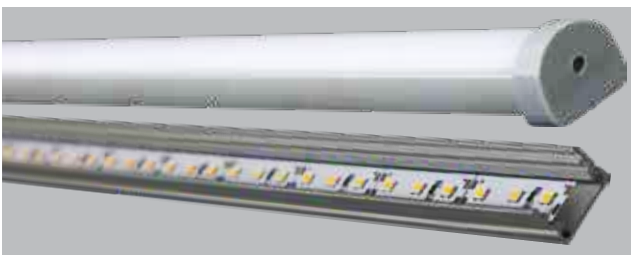

12 V

OSRAM LED

| Kod | Renk | Kesit | Güç | Işık Akısı | Fiyat |
|------------|-------|---------|---------|------------|-----------|
| AS10-11203 | 3000K | 12,5 mm | 14 W/mt | 950 lm/mt | 10,00 USD |
| AS10-11213 | 4000K | 12,5 mm | 14 W/mt | 1000 lm/mt | 10,00 USD |
| AS10-11233 | 6500K | 12,5 mm | 14 W/mt | 1050 lm/mt | 10,00 USD |



Diş mekan LED Barlar için lütfen fiyat alınız.



2 Amper LED Trafosu

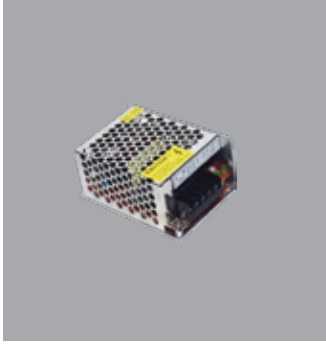

| Kod | Fiyat |
|------------------------------|-----------------|
| AY02-00250 | 7,00 USD |
| Boyut: 90 mm x 80 mm x 35 mm | |
| Giriş Gerilimi | : 220 V |
| Çıkış Gerilimi | : 12V |
| Güç | : 24 W |
| Akım | : 2 A |
| Koli Miktarı | : 80 ad |



5 Amper İnce Tip LED Trafosu



| Kod | Fiyat |
|-------------------------------|------------------|
| AY02-00600 | 11,10 USD |
| Boyut: 40 mm x 160 mm x 30 mm | |
| Giriş Gerilimi | : 220 V |
| Çıkış Gerilimi | : 12V |
| Güç | : 60 W |
| Akım | : 5 A |
| Koli Miktarı | : 50 ad |



10 Amper İnce Tip LED Trafosu



| Kod | Fiyat |
|-------------------------------|------------------|
| AY02-01000 | 15,20 USD |
| Boyut: 50 mm x 190 mm x 35 mm | |
| Giriş Gerilimi | : 220 V |
| Çıkış Gerilimi | : 12V |
| Güç | : 120 W |
| Akım | : 10 A |
| Koli Miktarı | : 50 ad |



12,5 Amper İnce Tip LED Trafosu



| Kod | Fiyat |
|-------------------------------|------------------|
| AY02-01500 | 20,30 USD |
| Boyut: 65 mm x 255 mm x 30 mm | |
| Giriş Gerilimi | : 220 V |
| Çıkış Gerilimi | : 12V |
| Güç | : 150 W |
| Akım | : 12,5 A |
| Koli Miktarı | : 40 ad |



16,5 Amper İnce Tip LED Trafosu

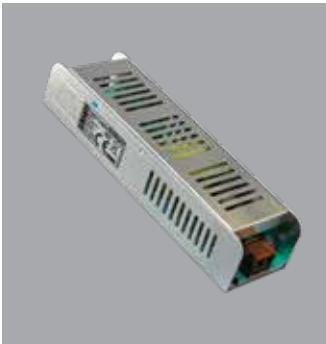

| Kod | Fiyat |
|-------------------------------|------------------|
| AY02-02000 | 24,10 USD |
| Boyut: 65 mm x 225 mm x 40 mm | |
| Giriş Gerilimi | : 220 V |
| Çıkış Gerilimi | : 12V |
| Güç | : 200 W |
| Akım | : 16,5 A |
| Koli Miktarı | : 30 ad |



20 Amper İnce Tip LED Trafosu



| Kod | Fiyat |
|-------------------------------|------------------|
| AY02-02500 | 27,50 USD |
| Boyut: 65 mm x 225 mm x 40 mm | |
| Giriş Gerilimi | : 220 V |
| Çıkış Gerilimi | : 12V |
| Güç | : 240 W |
| Akım | : 20 A |
| Koli Miktarı | : 30 ad |



30 Amper İnce Tip LED Trafosu (Fanlı)



| Kod | Fiyat |
|-------------------------------|------------------|
| AY02-03600 | 31,70 USD |
| Boyut: 75 mm x 225 mm x 45 mm | |
| Giriş Gerilimi | : 220 V |
| Çıkış Gerilimi | : 12V |
| Güç | : 360 W |
| Akım | : 30 A |
| Koli Miktarı | : 25 ad |



41 Amper İnce Tip LED Trafosu (Fanlı)



| Kod | Fiyat |
|--------------------------------|------------------|
| AY02-05000 | 51,00 USD |
| Boyut: 100 mm x 200 mm x 50 mm | |
| Giriş Gerilimi | : 220 V |
| Çıkış Gerilimi | : 12V |
| Güç | : 500 W |
| Akım | : 41 A |
| Koli Miktarı | : 28 ad |



LED Şeritler ve Sürücüler

LED Strips and Drivers

3 Çıplı, 60 LED'li Şerit LED'ler

RoHS Compliant | CE



| Kod | Renk | Fiyat |
|------------|---------|----------|
| AS01-00300 | 3000K | 2,10 USD |
| AS01-00301 | 4000K | 2,10 USD |
| AS01-00303 | 6500K | 2,10 USD |
| AS01-00304 | Kırmızı | 2,10 USD |
| AS01-00305 | Yeşil | 2,10 USD |
| AS01-00306 | Mavi | 2,10 USD |
| AS01-00308 | Amber | 2,10 USD |
| AS01-00309 | RGB | 3,50 USD |

Silikonsuzlar

Gerilim : DC 12 V
Güç : 14,4 W/mt
Işık Akısı : 15 lm/W
Koli Miktarı : 250 mt

IP20

220 V Şerit LED

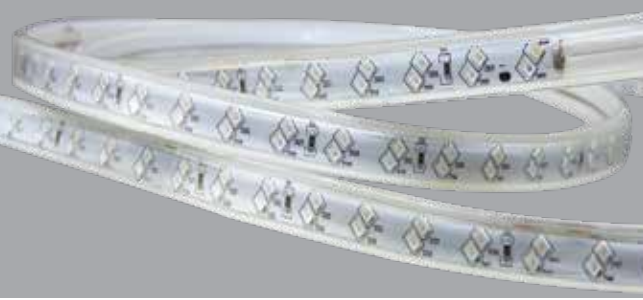

| Kod | Renk | Fiyat |
|------------|---------|----------|
| AS01-00500 | 3000K | 4,50 USD |
| AS01-00503 | 6500K | 4,50 USD |
| AS01-00504 | Kırmızı | 4,50 USD |
| AS01-00505 | Yeşil | 4,50 USD |
| AS01-00506 | Mavi | 4,50 USD |
| AS01-00508 | Amber | 4,50 USD |

Boyut: 6,5 mm x 14,2 mm

Gerilim : 220 V
Koli Miktarı : 50 mt/Roll
Güç : 6 W / mt
120 LED/mt

IP65

220 V
LED Şerit
Fişi



A05-95-005 3,44 USD

LED Neon Hortumlar



| Kod | Renk | Fiyat |
|------------|---------|-----------|
| AS03-00500 | 3000K | 7,00 USD |
| AS03-00503 | 6500K | 7,00 USD |
| AS03-00504 | Kırmızı | 7,00 USD |
| AS03-00505 | Yeşil | 7,00 USD |
| AS03-00506 | Mavi | 7,00 USD |
| AS03-00508 | Amber | 7,00 USD |
| AS03-00509 | RGB | 15,60 USD |

Gerilim : 220 V
Koli Miktarı : 50 mt/Roll
Güç : 7,5 W / mt
Güç (RGB) : 11 W / mt

IP65

Neon Hortum Kumandalı RGB Kontrol Modülü



AY30-01030 7,80 USD

Neon Hortum RGB Kontrol Modülü



AY30-01020 6,70 USD

Neon Hortum Fişi



A05-95-006 5,20 USD

Neon Hortum Köşe Dönüş Modülü

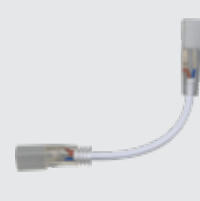

A05-95-008 2,64 USD

Neon Hortum Birleştirme Modülü



H05-95-003 1,32 USD

Şeffaf Üçlü LED Modül

IP65

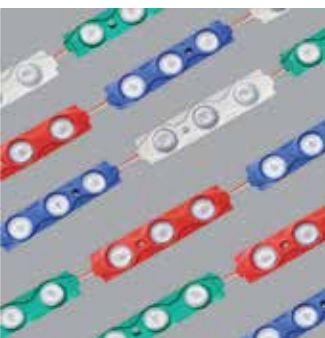

| Kod | Renk | Fiyat |
|------------|---------|----------|
| AS04-00200 | 3000K | 1,00 USD |
| AS04-00203 | 6500K | 1,00 USD |
| AS04-00204 | Kırmızı | 1,00 USD |
| AS04-00205 | Yeşil | 1,00 USD |
| AS04-00206 | Mavi | 1,00 USD |
| AS04-00100 | 3000K | 1,00 USD |
| AS04-00103 | 6500K | 1,00 USD |

Boyutlar: 82 mm x 18 mm x 8,6 mm

Gerilim : DC 12 V
Güç : 1,5 W / 1 md.
Işık Akısı : 117 lm / 1 md.
Koli Miktarı : 1000 ad

RoHS Compliant | CE | IP65

Tekli LED Modül

IP67



| Kod | Renk | Fiyat |
|------------|-------|----------|
| AS04-00300 | 3000K | 1,90 USD |
| AS04-00303 | 6500K | 1,90 USD |

Boyutlar: 43 mm x 23 mm x 7,8 mm

Gerilim : DC 12 V
Güç : 1,32 W / 1 Ad.
Işık Akısı : 125 lm / 1 Ad.
Koli Miktarı : 1000 ad

RoHS Compliant | CE | IP67

Sinek ve Uçan Haşere Öldürücü
Insect Killer

ACK



Sinek ve Uçan Haşere Öldürücü

Insect Killer



Ultra İnce Gövde / Çıkarılabilir Tepsili



- Sağlıklı, çevreye saygılı, kokusuz ve gazsız.
- Alırken ve kullanırken ekonomik.
- Kolay montaj, kolay temizlik.
- Tüpleri kolayca değiştirilebilir.
- Ev, restoran, çiftlik, fabrika, hastane, otel, ofis ve benzeri kapalı yerlerde rahatlıkla kullanılabilir.



16W

2x8W

53,00 USD

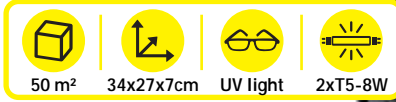

AG45-01600

340 mm X h 270 mm X 70 mm

VOLTAJ : 220/240 V
FREKANS : 50-60 Hz
MATERYAL : Alüminyum+ABS



8,000
saat/hour
Kullanım Ömrü

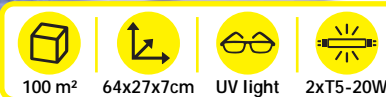
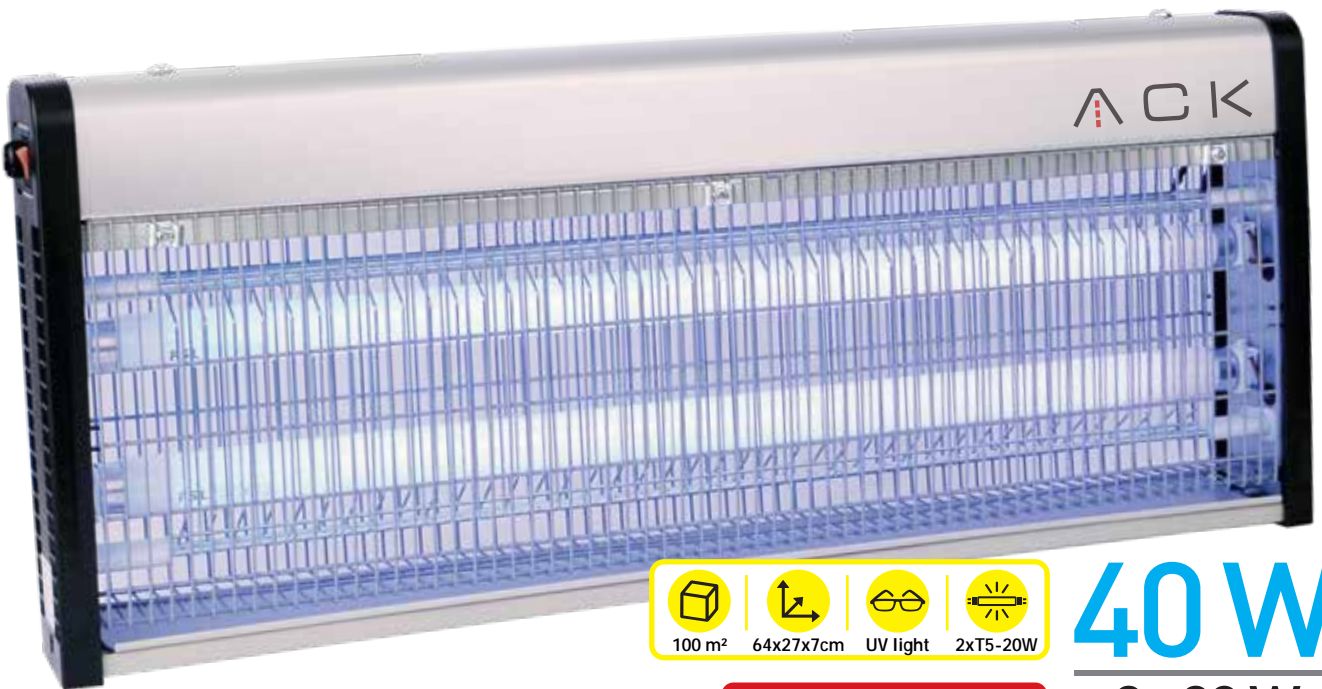

AG45-04000

640 mm X h 270 mm X 70 mm

40W

2x20W

75,00 USD

Dekoratif Sarkıt Armatürler, Aplikler ve Lineer Armatürler

Decorative Pendant Fixtures, Apliques and Linear Fixtures



Dekoratif Sarkıt armatür ve apliklerde özel renk talepleriniz için lütfen iletişime geçiniz.

Dekoratif Sarkıt Armatürler, Aplikler ve Lineer Armatürler

Decorative Pendant Fixtures, Apliques and Linear Fixtures

ACK

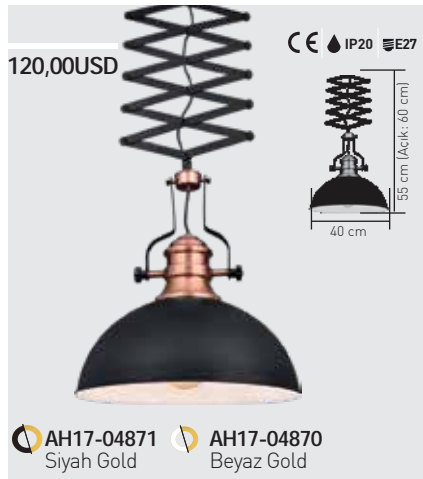
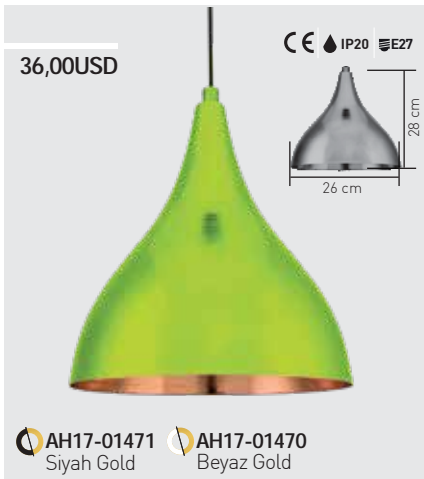

Dekoratif Sarkıt armatür ve apliklerde özel renk talepleriniz için lütfen iletişime geçiniz.

Dekoratif Sarkıt Armatürler, Aplikler ve Lineer Armatürler

Decorative Pendant Fixtures, Appliques and Linear Fixtures



Dekoratif Sarkıt Armatür ve apliklerde özel renk talepleriniz için lütfen iletişime geçiniz.

Dekoratif Sarkıt Armatürler, Aplikler ve Lineer Armatürler

Decorative Pendant Fixtures, Apliques and Linear Fixtures

ACK



Dekoratif Sarkıt armatür ve apliklerde özel renk talepleriniz için lütfen iletişime geçiniz.

Dekoratif Sarkıt Armatürler, Aplikler ve Lineer Armatürler

Decorative Pendant Fixtures, Appliques and Linear Fixtures

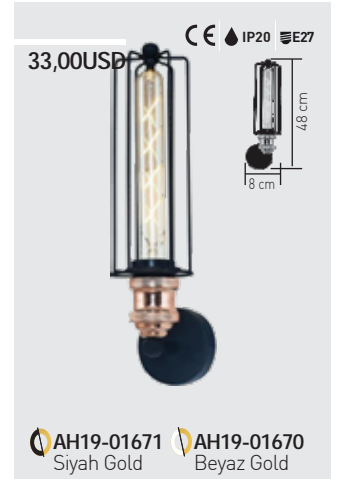

Dekoratif Sarkıt armatür ve apliklerde özel renk talepleriniz için lütfen iletişime geçiniz.

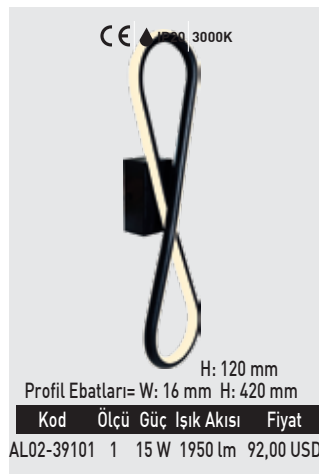

Dekoratif Sarkıt Armatürler, Aplikler ve Lineer Armatürler

Decorative Pendant Fixtures, Apliques and Linear Fixtures



CE IP20 3000K



H: 350 mm
Profil Ebatları= W: 80 mm H: 350 mm

| Kod | Ölçü | Güç | Işık Akısı | Fiyat |
|------------|------|------|------------|-----------|
| AL02-43101 | 1 | 15 W | 1950 lm | 88,00 USD |

CE IP20 3000K



H: 25 mm
Profil Ebatları= W: 80 mm H: 150 mm

| Kod | Ölçü | Güç | Işık Akısı | Fiyat |
|------------|------|------|------------|-----------|
| AL02-45101 | 1 | 15 W | 1950 lm | 63,00 USD |

CE IP20 3000K



H: 300 mm
Profil Ebatları= W: 80 mm H: 300 mm

| Kod | Ölçü | Güç | Işık Akısı | Fiyat |
|------------|------|------|------------|-----------|
| AL02-48101 | 1 | 15 W | 1950 lm | 83,00 USD |

CE IP20 3000K



H: 400 mm
Profil Ebatları= W: 80 mm H: 500 mm

| Kod | Ölçü | Güç | Işık Akısı | Fiyat |
|------------|------|------|------------|-----------|
| AL02-53101 | 1 | 15 W | 1950 lm | 67,00 USD |

CE IP20 3000K



H: 150 mm
Profil Ebatları= W: 80 mm H: 300 mm

| Kod | Ölçü | Güç | Işık Akısı | Fiyat |
|------------|------|------|------------|-----------|
| AL02-49101 | 1 | 15 W | 1950 lm | 67,00 USD |

CE IP20 3000K



H: 50 mm
Profil Ebatları= W: 80 mm H: 400 mm

| Kod | Ölçü | Güç | Işık Akısı | Fiyat |
|------------|------|------|------------|-----------|
| AL02-52101 | 1 | 15 W | 1950 lm | 63,00 USD |

CE IP20 3000K



H: 300 mm
Profil Ebatları= W: 80 mm H: 300 mm

| Kod | Ölçü | Güç | Işık Akısı | Fiyat |
|------------|------|------|------------|-----------|
| AL02-51101 | 1 | 15 W | 1950 lm | 88,00 USD |

CE IP20 3000K



H: 200 mm
Profil Ebatları= W: 16 mm H: 350 mm

| Kod | Ölçü | Güç | Işık Akısı | Fiyat |
|------------|------|------|------------|-----------|
| AL02-36101 | 1 | 15 W | 1950 lm | 88,00 USD |

CE IP20 3000K



Profil Ebatları= H: 100 mm

| Kod | Ölçü(cm) | Güç | Işık Akısı | Fiyat |
|------------|----------|-------|------------|------------|
| AL02-19101 | 100 | 100 W | 13000 lm | 444,00 USD |
| AL02-19201 | 120 | 150 W | 19500 lm | 533,00 USD |
| AL02-19501 | 150 | 200 W | 26000 lm | 666,00 USD |

CE IP20 3000K



Profil Ebatları= W: 80 mm H: 75 mm

| Kod | Ölçü(cm) | Güç | Işık Akısı | Fiyat |
|------------|----------|-------|------------|------------|
| AL02-05401 | 40x40 | 45 W | 5850 lm | 134,00 USD |
| AL02-05601 | 60x60 | 65 W | 8400 lm | 203,00 USD |
| AL02-05801 | 80x80 | 90 W | 11700 lm | 267,00 USD |
| AL02-05101 | 100x100 | 115 W | 14500 lm | 333,00 USD |

CE IP20 3000K



Profil Ebatları= W: 50 mm H: 85 mm

| Kod | Ölçü(cm) | Güç | Işık Akısı | Fiyat |
|------------|----------|------|------------|------------|
| AL02-16401 | 40 | 38 W | 3380 lm | 97,00 USD |
| AL02-16601 | 60 | 58 W | 8700 lm | 152,00 USD |
| AL02-16801 | 80 | 76 W | 13650 lm | 202,00 USD |
| AL02-16101 | 100 | 95 W | 19500 lm | 253,00 USD |

CE IP20 3000K

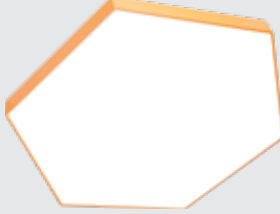

Profil Ebatları= H: 100 mm

| Kod | Ölçü(cm) | Güç | Işık Akısı | Fiyat |
|------------|----------|-------|------------|------------|
| AL02-17401 | 40 | 26 W | 3380 lm | 116,00 USD |
| AL02-17601 | 60 | 67 W | 8700 lm | 177,00 USD |
| AL02-17801 | 80 | 105 W | 13650 lm | 236,00 USD |
| AL02-17101 | 100 | 150 W | 19500 lm | 288,00 USD |

CE IP20 3000K



Profil Ebatları= W: 80 mm H: 75 mm

| Kod | Ölçü(cm) | Güç | Işık Akısı | Fiyat |
|------------|----------|-------|------------|------------|
| AL02-04401 | 40x40 | 45 W | 5850 lm | 70,00 USD |
| AL02-04601 | 60x60 | 60 W | 7800 lm | 177,00 USD |
| AL02-04801 | 80x80 | 85 W | 11000 lm | 231,00 USD |
| AL02-04101 | 100x100 | 105 W | 13500 lm | 297,00 USD |

CE IP20 3000K



Profil Ebatları= H: 100 mm

| Kod | Ölçü(cm) | Güç | Işık Akısı | Fiyat |
|------------|----------|-------|------------|------------|
| AL02-03401 | 40x40 | 45 W | 5850 lm | 122,00 USD |
| AL02-03601 | 60x60 | 60 W | 7800 lm | 188,00 USD |
| AL02-03801 | 80x80 | 85 W | 11000 lm | 250,00 USD |
| AL02-03101 | 100x100 | 105 W | 13500 lm | 311,00 USD |

Dekoratif Sarkıt Armatürler, Aplikler ve Lineer Armatürler

Decorative Pendant Fixtures, Apliques and Linear Fixtures

CE IP20 3000K



Profil Ebatları= W: 80 mm H: 75 mm

| Kod | Ölçü(cm) | Güç | Işık Akısı | Fiyat |
|------------|----------|------|------------|------------|
| AL02-13101 | 100 | 38 W | 5000 lm | 125,00 USD |
| AL02-13201 | 120 | 45 W | 5850 lm | 150,00 USD |
| AL02-13501 | 200 | 75 W | 9750 lm | 250,00 USD |

CE IP20 3000K



Profil Ebatları= W: 85 mm H: 85 mm

| Kod | Ölçü(cm) | Güç | Işık Akısı | Fiyat |
|------------|--------------|------|------------|------------|
| AL02-22401 | 40 x 40 | 33 W | 2730 lm | 110,00 USD |
| AL02-22601 | 60 x 60 | 50 W | 3380 lm | 166,00 USD |
| AL02-22101 | 1100 x 10084 | W | 8700 lm | 283,00 USD |

Profil Ebatları= W: 50 mm H: 85 mm

| Kod | Ölçü(cm) | Güç | Işık Akısı | Fiyat |
|------------|----------|------|------------|------------|
| AL02-24401 | 40 x 40 | 51 W | 6630 lm | 125,00 USD |
| AL02-24601 | 60 x 60 | 76 W | 9880 lm | 188,00 USD |

CE IP20 3000K



Profil Ebatları= H: 100 mm

| Kod | Ölçü(cm) | Güç | Işık Akısı | Fiyat |
|------------|-------------|------|------------|------------|
| AL02-06401 | 40x40 | 45 W | 5850 lm | 142,00 USD |
| AL02-06601 | 60x60 | 65 W | 8400 lm | 214,00 USD |
| AL02-06801 | 80x80 | 90 W | 11700 lm | 284,00 USD |
| AL02-06101 | 1100x100115 | W | 14500 lm | 378,00 USD |

CE IP20 3000K



Profil Ebatları= W: 80 mm H: 75 mm

| Kod | Ölçü(cm) | Güç | Işık Akısı | Fiyat |
|------------|----------|------|------------|------------|
| AL02-14101 | 100 | 32 W | 4160 lm | 105,00 USD |
| AL02-14201 | 120 | 38 W | 5000 lm | 125,00 USD |
| AL02-14501 | 150 | 48 W | 6240 lm | 158,00 USD |

CE IP20 3000K



Profil Ebatları= W: 80 mm H: 75 mm

| Kod | Ölçü(cm) | Güç | Işık Akısı | Fiyat |
|------------|----------|-------|------------|------------|
| AL02-15101 | 100 | 68 W | 8840 lm | 230,00 USD |
| AL02-15201 | 120 | 80 W | 10400 lm | 275,00 USD |
| AL02-15501 | 150 | 100 W | 13000 lm | 344,00 USD |

CE IP20 3000K



Profil Ebatları= W: 80 mm H: 75 mm

| Kod | Ölçü(cm) | Güç | Işık Akısı | Fiyat |
|------------|----------|------|------------|------------|
| AL02-01601 | 60x60 | 50 W | 6500 lm | 310,00 USD |
| AL02-01801 | 80x80 | 70 W | 9100 lm | 414,00 USD |
| AL02-01101 | 1100x100 | 90 W | 11,500 lm | 520,00 USD |

CE IP20 3000K



Profil Ebatları= W: 80 mm H: 75 mm

| Kod | Ölçü(cm) | Güç | Işık Akısı | Fiyat |
|------------|----------|------|------------|------------|
| AL02-09401 | 40 | 32 W | 4160 lm | 100,00 USD |
| AL02-09601 | 60 | 48 W | 6250 lm | 144,00 USD |
| AL02-09801 | 80 | 70 W | 10400 lm | 195,00 USD |
| AL02-09101 | 100 | 90 W | 11700 lm | 242,00 USD |

Profil Ebatları= W: 80 mm H: 75 mm

| Kod | Ölçü(cm) | Güç | Işık Akısı | Fiyat |
|------------|----------|------|------------|------------|
| AL02-07401 | 40 | 21 W | 2730 lm | 88,00 USD |
| AL02-07601 | 60 | 30 W | 3900 lm | 138,00 USD |
| AL02-07801 | 80 | 47 W | 6100 lm | 183,00 USD |
| AL02-07101 | 100 | 60 W | 7800 lm | 227,00 USD |

CE IP20 3000K



Profil Ebatları= H: 100 mm

| Kod | Ölçü(cm) | Güç | Işık Akısı | Fiyat |
|------------|----------|------|------------|------------|
| AL02-18301 | 30 | 21 W | 2730 lm | 97,00 USD |
| AL02-18401 | 40 | 26 W | 3380 lm | 130,00 USD |
| AL02-18601 | 60 | 67 W | 8700 lm | 194,00 USD |

CE IP20 3000K



Profil Ebatları= W: 50 mm H: 85 mm

| Kod | Ölçü(cm) | Güç | Işık Akısı | Fiyat |
|------------|----------|-------|------------|------------|
| AL02-08301 | 30 | 21 W | 2730 lm | 77,00 USD |
| AL02-08401 | 40 | 26 W | 3380 lm | 105,00 USD |
| AL02-08601 | 60 | 67 W | 8700 lm | 158,00 USD |
| AL02-08801 | 80 | 105 W | 13650 lm | 272,00 USD |
| AL02-08101 | 100 | 150 W | 19500 lm | 375,00 USD |

CE IP20 3000K



Profil Ebatları= W: 80 mm H: 75 mm

| Kod | Ölçü(cm) | Güç | Işık Akısı | Fiyat |
|------------|----------|------|------------|------------|
| AL02-00601 | 20x20 | 20 W | 2600 lm | 75,00 USD |
| AL02-00801 | 30x30 | 30 W | 3900 lm | 110,00 USD |

CE IP20 3000K



Profil Ebatları= H: 100 mm

| Kod | Ölçü(cm) | Güç | Işık Akısı | Fiyat |
|------------|----------|------|------------|-----------|
| AL02-23401 | 20x20 | 20 W | 2600 lm | 53,00 USD |
| AL02-23601 | 30x30 | 30 W | 3900 lm | 84,00 USD |

Dekoratif Sarkıt Armatürler, Aplikler ve Lineer Armatürler

Decorative Pendant Fixtures, Appliques and Linear Fixtures

CE IP20 3000K



Profil Ebatları= W: 80 mm H: 75 mm

| Kod | Ölçü(cm) | Güç | Işık Akısı | Fiyat |
|------------|-----------|-------|------------|-------------|
| AL02-02701 | 50x70x50 | 160 W | 9750 lm | 920,00 USD |
| AL02-02801 | 60x80x60 | 190 W | 13000 lm | 1084,00 USD |
| AL02-01101 | 60-100-60 | 210 W | 19500 lm | 1195,00 USD |

Profil Ebatları= W: 50 mm H: 85 mm

| Kod | Ölçü(cm) | Güç | Işık Akısı | Fiyat |
|------------|----------|-------|------------|-------------|
| AL02-25601 | 60x60 | 150 W | 19500 lm | 744,00 USD |
| AL02-25801 | 80x80 | 200 W | 26000 lm | 994,00 USD |
| AL02-25101 | 100x100 | 250 W | 32500 lm | 1250,00 USD |



CE IP20

CE IP20 3000K



Profil Ebatları= 32X38 H: 130 mm

| Kod | Ölçü(cm) | Güç | Işık Akısı | Fiyat |
|------------|----------|-------|------------|------------|
| AL02-00601 | 60x60 | 75 W | 9750 lm | 380,00 USD |
| AL02-00801 | 80x80 | 100 W | 13000 lm | 511,00 USD |
| AL02-00101 | 100x100 | 150 W | 19500 lm | 638,00 USD |

CE IP20 3000K

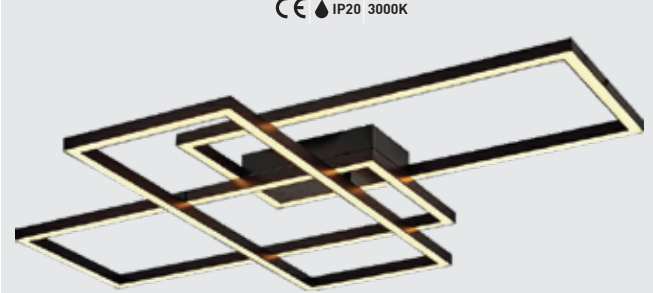

Profil Ebatları= W: 32 mm H: 38 mm

| Kod | Ölçü(cm) | Güç | Işık Akısı | Fiyat |
|------------|----------|-------|------------|------------|
| AL02-21601 | 30x60 | 113 W | 14960 lm | 555,00 USD |
| AL02-21801 | 30x80 | 138 W | 17940 lm | 683,00 USD |
| AL02-21201 | 30x120 | 190 W | 24700 lm | 933,00 USD |

Profil Ebatları= W: 150 mm H: 100 mm

| Kod | Ölçü(cm) | Güç | Işık Akısı | Fiyat |
|------------|----------|------|------------|------------|
| AL02-10001 | 115X100 | 42 W | 5450 lm | 133,00 USD |
| AL02-10201 | 115X120 | 50 W | 6500 lm | 160,00 USD |
| AL02-10501 | 115X150 | 63 W | 8190 lm | 200,00 USD |
| AL02-10503 | 115X200 | 84 W | 10900 lm | 266,00 USD |



Profil Ebatları= W: 200 mm H: 100 mm

| Kod | Ölçü(cm) | Güç | Işık Akısı | Fiyat |
|------------|----------|------|------------|------------|
| AL02-11101 | 120X100 | 63 W | 8190 lm | 153,00 USD |
| AL02-11201 | 120X120 | 75 W | 9750 lm | 178,00 USD |
| AL02-11501 | 120X150 | 95 W | 12300 lm | 228,00 USD |

Profil Ebatları= W: 300 mm H: 100 mm

| Kod | Ölçü(cm) | Güç | Işık Akısı | Fiyat |
|------------|----------|-------|------------|------------|
| AL02-12101 | 130X100 | 84 W | 10900 lm | 222,00 USD |
| AL02-12201 | 130X120 | 100 W | 13000 lm | 266,00 USD |
| AL02-12501 | 130X150 | 126 W | 21800 lm | 333,00 USD |

CE IP20 3000K



Profil Ebatları= W: 10 mm H: 40 mm

| Kod | Ölçü(cm) | Güç | Işık Akısı | Fiyat |
|------------|----------|-------|------------|------------|
| AL02-27401 | 40-50 | 95 W | 12350 lm | 444,00 USD |
| AL02-27501 | 50-60 | 103 W | 13390 lm | 458,00 USD |
| AL02-27801 | 80-90 | 160 W | 20800 lm | 755,00 USD |

CE IP20 3000K



Profil Ebatları= W: 10 mm H: 40 mm

| Kod | Ölçü(cm) | Güç | Işık Akısı | Fiyat |
|------------|----------|-------|------------|------------|
| AL02-32601 | 40-50-60 | 140 W | 18200 lm | 666,00 USD |
| AL02-32701 | 50-60-70 | 170 W | 22100 lm | 802,00 USD |
| AL02-32801 | 40-60-80 | 170 W | 22100 lm | 802,00 USD |

CE IP20 3000K



Profil Ebatları= W: 35 mm H: 8 mm

| Kod | Ölçü(cm) | Güç | Işık Akısı | Fiyat |
|------------|----------|------|------------|------------|
| AL02-29301 | 30-40-50 | 56 W | 7280 lm | 338,00 USD |
| AL02-29501 | 50-60-70 | 85 W | 11000 lm | 505,00 USD |
| AL02-29401 | 40-60-80 | 85 W | 11000 lm | 505,00 USD |

CE IP20 3000K



Profil Ebatları= W: 10 mm H: 40 mm

| Kod | Ölçü(cm) | Güç | Işık Akısı | Fiyat |
|------------|----------|-------|------------|------------|
| AL02-26601 | 40-50 | 95 W | 12350 lm | 519,00 USD |
| AL02-26701 | 50-60 | 103 W | 13390 lm | 566,00 USD |
| AL02-26801 | 80-90 | 160 W | 20800 lm | 877,00 USD |

CE IP20 3000K

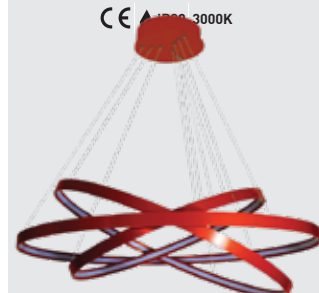

Profil Ebatları= W: 10 mm H: 40 mm

| Kod | Ölçü(cm) | Güç | Işık Akısı | Fiyat |
|------------|----------|------|------------|------------|
| AL02-31601 | 30-40-50 | 56 W | 7280 lm | 333,00 USD |
| AL02-31701 | 50-60-70 | 85 W | 11000 lm | 505,00 USD |
| AL02-31801 | 40-60-80 | 85 W | 11000 lm | 505,00 USD |

Dekoratif Seramik ve Alçı Spot Armatürler

Decorative Spot Fixtures



| Kod | Kesim | Fiyat |
|------------|-------|-----------|
| AH01-04016 | 65 mm | 17,00 USD |

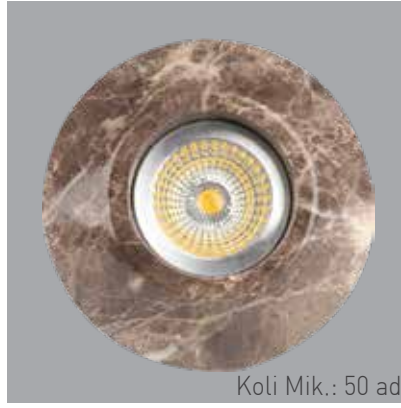

| Kod | Kesim | Fiyat |
|------------|-------|-----------|
| AH04-01037 | 65 mm | 15,00 USD |



| Kod | Kesim | Fiyat |
|------------|-------|-----------|
| AH04-01047 | 65 mm | 15,00 USD |



| Kod | Kesim | Fiyat |
|------------|-------|-----------|
| AH01-04056 | 65 mm | 17,00 USD |



| Kod | Kesim | Fiyat |
|------------|-------|-----------|
| AH01-04066 | 65 mm | 17,00 USD |



| Kod | Kesim | Fiyat |
|------------|-------|-----------|
| AH01-04046 | 65 mm | 17,00 USD |



| Kod | Kesim | Fiyat |
|------------|-------|-----------|
| AH01-04076 | 65 mm | 17,00 USD |



| Kod | Kesim | Fiyat |
|------------|-------|-----------|
| AH01-04086 | 65 mm | 17,00 USD |



| Kod | Kesim | Fiyat |
|------------|-------|-----------|
| AH01-04096 | 65 mm | 17,00 USD |



| Kod | Kesim | Fiyat |
|------------|-------|-----------|
| AH01-04106 | 65 mm | 17,00 USD |



| Kod | Kesim | Fiyat |
|------------|-------|-----------|
| AH04-01016 | 65 mm | 15,00 USD |



| Kod | Kesim | Fiyat |
|------------|-------|-----------|
| AH04-01026 | 65 mm | 15,00 USD |

Dekoratif Seramik ve Alçı Spot Armatürler

Decorative Spot Fixtures

ACK



| Kod | Kesim | Fiyat |
|------------|-------|-----------|
| AH04-01216 | 65 mm | 15,00 USD |



| Kod | Kesim | Fiyat |
|------------|-------|-----------|
| AH04-01227 | 65 mm | 15,00 USD |



| Kod | Kesim | Fiyat |
|------------|-------|-----------|
| AH04-01051 | 65 mm | 15,00 USD |



| Kod | Kesim | Fiyat |
|------------|-------|-----------|
| AH04-01066 | 65 mm | 15,00 USD |



| Kod | Kesim | Fiyat |
|------------|-------|-----------|
| AH04-01076 | 65 mm | 15,00 USD |



| Kod | Kesim | Fiyat |
|------------|-------|-----------|
| AH04-01326 | 65 mm | 15,00 USD |



| Kod | Kesim | Fiyat |
|------------|-------|-----------|
| AH04-01146 | 65 mm | 15,00 USD |



| Kod | Kesim | Fiyat |
|------------|-------|-----------|
| AH04-01106 | 65 mm | 15,00 USD |



| Kod | Kesim | Fiyat |
|------------|-------|-----------|
| AH04-01160 | 65 mm | 15,00 USD |



| Kod | Kesim | Fiyat |
|------------|-------|-----------|
| AH04-01115 | 65 mm | 15,00 USD |



| Kod | Kesim | Fiyat |
|------------|-------|-----------|
| AH04-01116 | 65 mm | 15,00 USD |



| Kod | Kesim | Fiyat |
|------------|-------|-----------|
| AH04-01117 | 65 mm | 15,00 USD |

Dekoratif Seramik ve Alçı Spot Armatürler

Decorative Spot Fixtures



| Kod | Kesim | Fiyat |
|------------|-------|-----------|
| AH04-01276 | 65 mm | 15,00 USD |



| Kod | Kesim | Fiyat |
|------------|-------|-----------|
| AH04-01135 | 65 mm | 15,00 USD |



| Kod | Kesim | Fiyat |
|------------|-------|-----------|
| AH04-01136 | 65 mm | 15,00 USD |



| Kod | Kesim | Fiyat |
|------------|-------|-----------|
| AH04-01285 | 65 mm | 15,00 USD |



| Kod | Kesim | Fiyat |
|------------|-------|-----------|
| AH04-01280 | 65 mm | 15,00 USD |



| Kod | Kesim | Fiyat |
|------------|-------|-----------|
| AH04-01286 | 65 mm | 15,00 USD |



| Kod | Kesim | Fiyat |
|------------|-------|-----------|
| AH04-01156 | 65 mm | 15,00 USD |



| Kod | Kesim | Fiyat |
|------------|-------|-----------|
| AH04-01161 | 65 mm | 15,00 USD |



| Kod | Kesim | Fiyat |
|------------|-------|-----------|
| AH04-01165 | 65 mm | 15,00 USD |



| Kod | Kesim | Fiyat |
|------------|-------|-----------|
| AH04-01296 | 65 mm | 15,00 USD |



| Kod | Kesim | Fiyat |
|------------|-------|-----------|
| AH04-01177 | 65 mm | 15,00 USD |



| Kod | Kesim | Fiyat |
|------------|-------|-----------|
| AH04-01179 | 65 mm | 15,00 USD |

Dekoratif Seramik ve Alçı Spot Armatürler

Decorative Spot Fixtures

ACK



| Kod | Kesim | Fiyat |
|------------|-------|-----------|
| AH04-01186 | 65 mm | 15,00 USD |

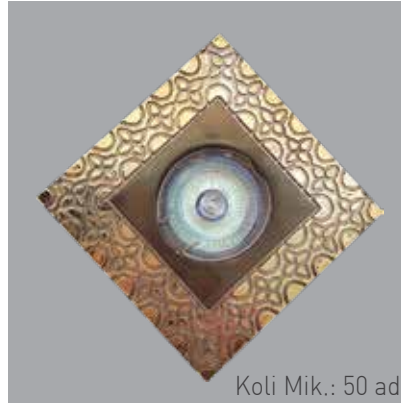

| Kod | Kesim | Fiyat |
|------------|-------|-----------|
| AH04-01196 | 65 mm | 15,00 USD |



| Kod | Kesim | Fiyat |
|------------|-------|-----------|
| AH04-01206 | 65 mm | 15,00 USD |



| Kod | Kesim | Fiyat |
|------------|-------|-----------|
| AH04-01345 | 65 mm | 15,00 USD |



| Kod | Kesim | Fiyat |
|------------|-------|-----------|
| AH04-01346 | 65 mm | 15,00 USD |



| Kod | Kesim | Fiyat |
|------------|-------|-----------|
| AH04-01347 | 65 mm | 15,00 USD |



| Kod | Kesim | Fiyat |
|------------|-------|-----------|
| AH04-01229 | 65 mm | 15,00 USD |



| Kod | Kesim | Fiyat |
|------------|-------|-----------|
| AH04-01235 | 65 mm | 15,00 USD |



| Kod | Kesim | Fiyat |
|------------|-------|-----------|
| AH04-01236 | 65 mm | 15,00 USD |



| Kod | Kesim | Fiyat |
|------------|-------|-----------|
| AH04-01247 | 65 mm | 15,00 USD |



| Kod | Kesim | Fiyat |
|------------|-------|-----------|
| AH04-01257 | 65 mm | 15,00 USD |



| Kod | Kesim | Fiyat |
|------------|-------|-----------|
| AH04-01266 | 65 mm | 15,00 USD |

Dekoratif Seramik ve Alçı Spot Armatürler

Decorative Spot Fixtures



Koli Mik.: 50 ad

| Kod | Kesim | Fiyat |
|------------|-------|-----------|
| AH04-01316 | 65 mm | 15,00 USD |



Koli Mik.: 50 ad

| Kod | Kesim | Fiyat |
|------------|-------|-----------|
| AH04-01306 | 65 mm | 15,00 USD |



Koli Mik.: 50 ad

| Kod | Kesim | Fiyat |
|------------|-------|-----------|
| AH04-01336 | 65 mm | 15,00 USD |

Dekoratif LED Spot Armatürler

Decorative LED Spot Fixtures



Renk: 6500K Koli Mik.: 100 ad

| Kod | Kesim | Fiyat |
|------------|-------|-----------|
| AH02-00133 | 65 mm | 16,00 USD |



Renk: 3000K Koli Mik.: 100 ad

| Kod | Kesim | Fiyat |
|------------|-------|----------|
| AH02-01006 | 65 mm | 8,00 USD |



Renk: 6500K Koli Mik.: 100 ad

| Kod | Kesim | Fiyat |
|------------|-------|----------|
| AH02-01133 | 65 mm | 9,00 USD |



Renk: 6500K Koli Mik.: 100 ad

| Kod | Kesim | Fiyat |
|------------|-------|-----------|
| AH02-00233 | 65 mm | 10,50 USD |



Renk: 3000K Koli Mik.: 100 ad

| Kod | Kesim | Fiyat |
|------------|-------|-----------|
| AH02-00206 | 65 mm | 10,50 USD |



Renk: 6500K Koli Mik.: 100 ad

| Kod | Kesim | Fiyat |
|------------|-------|----------|
| AH02-01733 | 65 mm | 9,00 USD |



Renk: 6500K Koli Mik.: 100 ad

| Kod | Kesim | Fiyat |
|------------|-------|-----------|
| AH02-01533 | 65 mm | 15,00 USD |



Renk: 6500K Koli Mik.: 100 ad

| Kod | Kesim | Fiyat |
|------------|-------|-----------|
| AH04-01233 | 65 mm | 12,00 USD |



Kesim: 65 mm Koli Mik.: 100 ad

| Kod | Renk | Fiyat |
|------------|-------|-----------|
| AH04-01303 | 3000K | 15,00 USD |
| AH12-01333 | 6500K | 15,00 USD |



| Kod | Kesim | Fiyat |
|------------|-------|-----------|
| AH01-02123 | 65 mm | 18,00 USD |



| Kod | Kesim | Fiyat |
|------------|-------|-----------|
| AH01-02104 | 65 mm | 16,00 USD |



| Kod | Kesim | Fiyat |
|------------|-------|-----------|
| AH01-02044 | 65 mm | 18,00 USD |



| Kod | Kesim | Fiyat |
|------------|-------|-----------|
| AH01-02046 | 65 mm | 18,00 USD |



| Kod | Kesim | Fiyat |
|------------|-------|-----------|
| AH01-02054 | 65 mm | 28,00 USD |



| Kod | Kesim | Fiyat |
|------------|-------|-----------|
| AH01-02056 | 65 mm | 28,00 USD |



| Kod | Kesim | Fiyat |
|------------|-------|-----------|
| AH01-02076 | 65 mm | 13,00 USD |

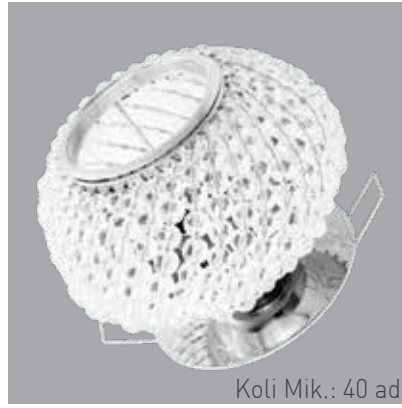

| Kod | Kesim | Fiyat |
|------------|-------|-----------|
| AH01-02084 | 65 mm | 18,00 USD |



| Kod | Kesim | Fiyat |
|------------|-------|-----------|
| AH01-02094 | 65 mm | 16,00 USD |



| Kod | Kesim | Fiyat |
|------------|-------|-----------|
| AH01-02096 | 65 mm | 16,00 USD |



| Kod | Kesim | Fiyat |
|------------|-------|-----------|
| AH01-02133 | 65 mm | 18,00 USD |



| Kod | Kesim | Fiyat |
|------------|-------|-----------|
| AH01-02113 | 65 mm | 18,00 USD |

Dekoratif Spot Armatürler

Decorative Spot Fixtures



Duy: G4

Koli Mik.: 30 ad

| Kod | Kesim | Fiyat |
|----------|-------|-----------|
| 1602-051 | 45 mm | 12,00 USD |



Koli Mik.: 50 ad

| Kod | Kesim | Fiyat |
|------------|-------|----------|
| AH01-01123 | 55 mm | 3,80 USD |



Koli Mik.: 200 ad

| Kod | Kesim | Fiyat |
|------------|-------|----------|
| AH01-01113 | 55 mm | 3,80 USD |



Koli Mik.: 100 ad

| Kod | Kesim | Fiyat |
|------------|-------|----------|
| AH01-01053 | 65 mm | 9,00 USD |



Koli Mik.: 50 ad

| Kod | Kesim | Fiyat |
|------------|-------|-----------|
| AH01-01085 | 65 mm | 12,00 USD |



Koli Mik.: 50 ad

| Kod | Kesim | Fiyat |
|------------|-------|-----------|
| AH01-01076 | 50 mm | 12,00 USD |



Koli Mik.: 100 ad

| Kod | Kesim | Fiyat |
|------------|-------|----------|
| AH01-01065 | 55 mm | 9,00 USD |



Duy: G4

Koli Mik.: 30 ad

| Kod | Kesim | Fiyat |
|----------|-------|----------|
| 1602-017 | 45 mm | 4,00 USD |



Koli Mik.: 50 ad

| Kod | Kesim | Fiyat |
|------------|-------|-----------|
| AH01-01105 | 60 mm | 13,00 USD |



Süsleme Işıkları

Ornamental Lights

ACK

Eklenebilir LED Işıklar

| Kod | Renk | Fiyat |
|------------|---------|-----------|
| AS90-00400 | 3000K | 13,30 USD |
| AS90-00403 | 6500K | 13,30 USD |
| AS90-00404 | Kırmızı | 13,30 USD |
| AS90-00405 | Yeşil | 13,30 USD |
| AS90-00406 | Mavi | 13,30 USD |

Gerilim: : 220 V
Koli Miktarı : 100 Ad
Özellikleri : Birbirine eklenebilir,
10 m. 100 LED ampülü.

Modülatörlü Twinkle LED Işıklar

| Kod | Renk | Fiyat |
|------------|------|-----------|
| AS90-00709 | Mix | 14,70 USD |

Gerilim: : 220 V
Koli Miktarı : 100 Ad
Özellikleri : 10 m. 100 LED ampülü.

2X2 LED Perdeler

| Kod | Renk | Fiyat |
|------------|---------|-----------|
| AS90-00500 | 3000K | 81,20 USD |
| AS90-00503 | 6500K | 81,20 USD |
| AS90-00504 | Kırmızı | 81,20 USD |
| AS90-00506 | Mavi | 81,20 USD |

Gerilim: : 220 V
Koli Miktarı : 10 Ad
Özellikleri : 200 cm X 200 cm

LED Akar Perdeler

| Kod | Renk | Fiyat |
|------------|-------|------------|
| AS90-00603 | 6500K | 102,00 USD |
| AS90-00606 | Mavi | 102,00 USD |

Gerilim: : 220 V
Koli Miktarı : 10 Ad
Özellikleri : 200 cm X 200 cm

Lüks Seri Eklenebilir LED Işıklar ★

| Kod | Renk | Kablo R. | Fiyat |
|------------|---------|----------|-----------|
| AS90-00100 | 3000K | Beyaz | 51,00 USD |
| AS90-00103 | 6500K | Beyaz | 51,00 USD |
| AS90-00104 | Kırmızı | Yeşil | 51,00 USD |
| AS90-00105 | Yeşil | Yeşil | 51,00 USD |
| AS90-00106 | Mavi | Yeşil | 51,00 USD |
| AS90-00109 | RGB | Yeşil | 56,00 USD |
| AS90-01000 | 3000K | Yeşil | 51,00 USD |
| AS90-01003 | 6500K | Yeşil | 51,00 USD |

Gerilim: : 220 V
Koli Miktarı : 10 Ad
Özellikleri : 100 LED'li eklenebilir, 10 mt
AS90-00109 modülatörlüdür, eklenemez.

Lüks Seri LED Perdeler ★

| Kod | Renk | Fiyat |
|------------|-------|------------|
| AS90-00300 | 3000K | 210,00 USD |
| AS90-00303 | 6500K | 210,00 USD |
| AS90-00306 | Mavi | 210,00 USD |

Gerilim: : 220 V
Koli Miktarı : 8 Ad
Özellikleri : 200 cm X 200 cm

Lüks Seri LED Saçak Işıklar ★

| Kod | Renk | Fiyat |
|------------|-------|-----------|
| AS90-00200 | 3000K | 77,00 USD |
| AS90-00203 | 6500K | 77,00 USD |

Gerilim: : 220 V
Koli Miktarı : 10 Ad
Özellikleri : 200 cm X 80/60/40 cm

192 LED'li Saçak Işıklar

| Kod | Güç | Işık A. | Renk | Fiyat |
|------------|-----|---------|-------|-----------|
| AS90-00800 | 9 W | 765 lm | 3000K | 31,00 USD |
| AS90-00803 | 9 W | 765 lm | 6500K | 31,00 USD |

Gerilim: : 220 V
Koli Miktarı : 40 Ad
En fazla 5 set
bağlanabilir.



Pilli LED Süsleme Işığı (Peri LED)

| Kod | Renk | LED | Uzun. | Fiyat |
|------------|-------|--------|-------|----------|
| AS90-00950 | 3000K | 50 ad | 5 mt | 6,65 USD |
| AS90-00953 | 6500K | 50 ad | 5 mt | 6,65 USD |
| AS90-00990 | 3000K | 100 ad | 10 mt | 8,80 USD |
| AS90-00993 | 6500K | 100 ad | 10 mt | 8,80 USD |



Gerilim: : 220 V
Koli Miktarı : 200 Ad
Özellikleri : 3 x AAA Battery (Pil dahil değildir)

Aspiratörler / Aspirators

Aksiyal Fanlar



Aircol-100 140,00 TL



Aircol-120 160,00 TL



Aircol-150 200,00 TL



Aircol-200 260,00 TL



Aircol-100 (Krom) 180,00 TL



Aircol-120 (Krom) 215,00 TL



Aircol-150 (Krom) 235,00 TL



Aircol-200 (Krom) 335,00 TL



Aircol-100 OP 240,00 TL



Aircol-120 OP 270,00 TL



Aircol-150 OP 325,00 TL



Aircol-100 MP 195,00 TL



Aircol-120 MP 220,00 TL



Aircol-150 MP 250,00 TL



Aircol-100 SM 165,00 TL



Aircol-120 SM 195,00 TL

Kapaklı Fanlar



Aircol-20 K 390,00 TL



Aircol-25 K 480,00 TL



Aircol-150 K 260,00 TL



Aircol-200 K 285,00 TL

Kanal Tipi
Aksiyal
Fanlar



Aircol-100 KT 130,00 TL



Aircol-120 KT 145,00 TL



Aircol-150 KT 185,00 TL

Tavan Tipi
Radyal
Fanlar



Aircol Spring 350,00 TL



Aircol Spring Light 412,00 TL



Aircol-250 485,00 TL



Aircol 250F 580,00 TL

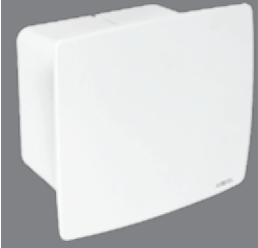

Aircol Lux 515,00 TL

Endüstriyel
Aksiyal
Fanlar



Aircol- S 300 750,00 TL
Aircol- S 400 825,00 TL
Aircol- S 450 935,00 TL

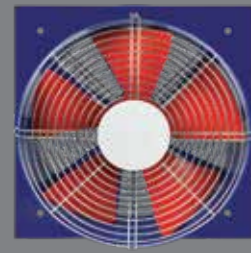

S Kare Serisi:
Aircol-S300 875,00 TL
Aircol-S400 1000,00 TL
Aircol-S500 1150,00 TL

Salyangoz
Radyal
Fanlar



Aircol-AKS 120-60 435,00 TL
Aircol-AKS 140-60 485,00 TL
Aircol-AKS 160-60 570,00 TL

70w Siva Altı Metal Armatür



| Kod | Renk | Fiyat |
|----------|-------|---------|
| 1204-001 | Krom | Lütfen |
| 1204-002 | Saten | Fiyat |
| 1204-003 | Beyaz | Sorunuz |

220 V - Rx7s - IP20



150w Siva Altı Metal Armatür



| Kod | Renk | Fiyat |
|----------|-------|---------|
| 1204-004 | Krom | Lütfen |
| 1204-005 | Saten | Fiyat |
| | | Sorunuz |

220 V - Rx7s - IP20



9W S/A Dekoratif LED Panel

Kasa: Krom



| Kod | Renk | Fiyat |
|------------|-------|-----------|
| AH04-10905 | 3000K | 17,00 USD |
| AH04-10935 | 6500K | 17,00 USD |

Kesim Ölçüsü: 130mm
20 ad - IP20
220 V - 9 W - 720 lm

12W S/A Dekoratif LED Panel

Kasa: Krom ve Gold



| Kod | Renk | Fiyat |
|------------|-------|-----------|
| AH04-11205 | 3000K | 21,00 USD |
| AH04-11235 | 6500K | 21,00 USD |
| AH04-11236 | 6500K | 21,00 USD |

Kesim Ölçüsü: 155mm
20 ad - IP20
220 V - 12 W - 960 lm

Sivaaltı 2 Renkli LED Panel



| Kod | Fiyat |
|------------|-----------|
| AP30-31800 | 20,00 USD |

3000K+Mavi
Kesim Ölçüsü: 200 mm.
10 ad - IP20
220 V - 18+2W - 1350 lm

4x8W Kare COB LED Spot Armatür



Kesim Ölçüsü: 170mm x 170mm

| Kod | Renk | Fiyat |
|----------|-------|---------|
| 5004-015 | Beyaz | Lütfen |
| | | Fiyat |
| | | Sorunuz |

8 ad - IP20

220 V - 32 W - 560 lm

8W COB LED Downlight



Renk: 6500K Kasa: Beyaz

| Kod | Kesim | Fiyat |
|----------|--------|-----------|
| 5003-023 | 110 mm | 10,00 USD |

20 ad - IP20

Bahçe Duvar Aydınlatma Aplığı



| Kod | Fiyat |
|------------|-----------|
| AG31-00104 | 26,00 USD |

10 ad - IP44

220 V - max. 60 W - E27

1 x 12 w Power LED projektör



5601-003 5601-007

| Kod | Renk | Fiyat |
|----------|---------|-----------|
| 5601-003 | Beyaz | 13,00 USD |
| 5601-007 | I.Beyaz | 13,00 USD |

10 ad - IP65

220 V - 18 W - 1480 lm

35-70-150W Siva Altı Metal Armatür



BOŞ

| Kod | Renk | Fiyat |
|----------|-------|-----------|
| 1206-001 | Beyaz | 26,00 USD |

Kesim Ölçüsü: 150mm x 150mm

12 ad

220 V G12 IP20 - 355°

35-70-150W Siva Altı Metal Armatür



BOŞ

| Kod | Renk | Fiyat |
|----------|-------|-----------|
| 1206-002 | Beyaz | 46,00 USD |

Kesim Ölçüsü: 150mm x 300mm

6 ad

220 V G12 IP20 - 355°

35-70-150W Siva Altı Metal Armatür



BOŞ

| Kod | Renk | Fiyat |
|----------|-------|-----------|
| 1206-003 | Beyaz | 66,00 USD |

Kesim Ölçüsü: 150mm x 450mm

6 ad

220 V G12 IP20 - 355°

Sivaaltı Yuvarlak LED Downlight



Gövde: Beyaz

| Kod | Güç | I. Akısı | Renk | Kesim | Fiyat |
|----------|------|----------|-------|--------|----------|
| 6005-005 | 12 W | 1080 lm | 6500K | 130 mm | 7,00 USD |
| 6005-008 | 16 W | 1440 lm | 3000K | 155 mm | 8,00 USD |
| 6005-007 | 16 W | 1440 lm | 6500K | 155 mm | 8,00 USD |

Gerilim:220 V



IP68 Şerit LED / Tek Çip

| Kod | Renk | Fiyat |
|----------|---------|---------|
| 5280-001 | Mavi | Fiyat |
| 5280-002 | Beyaz | Sorunuz |
| 5280-003 | I.Beyaz | |
| 5280-004 | Kırmızı | |
| 5280-005 | Yeşil | |

IP68

IP68 Şerit LED / Üç Çip

| Kod | Renk | Fiyat |
|----------|-------|---------|
| 5281-002 | Beyaz | Fiyat |
| 5281-005 | Yeşil | Sorunuz |



Yüksek Lümenli Şerit LED

| Kod | Renk | Fiyat |
|------------|-------|----------|
| AS01-00700 | 3000K | 5,00 USD |
| AS01-00703 | 6500K | 5,00 USD |

Gerilim : 12 V
Güç : 14,4 W/mt
Işık Akısı : 23 lm/W
Koli Miktarı : 450 mt
IP20



Tek Çipli, 60 LED'li / Silikonsuzlar

| Kod | Renk | Fiyat |
|------------|---------|----------|
| AS01-00104 | Kırmızı | 1,50 USD |
| AS01-00105 | Yeşil | 1,50 USD |

Gerilim : DC 12 V
Güç : 4,8 W/mt
Işık Akısı : 5 lm/W
Koli Miktarı : 250 mt
IP20

ACK



acklighting



Işığın

Yeni Adı



www.acklighting.com



Bizi Facebook, Instagram ve LinkedIn hesaplarımızdan da takip edebilirsiniz.