

SOLMAZSAN®

Fiyat Listesi
Eylül 2020

www.solmazsan.com.tr

SOLMAZSAN®
ELEKTRİK

Değerli çözüm ortağımız;

2009 yılında kurulan Solmazsan Elektrik Malzemeleri ve Klemens İmalat San. Tic. Ltd. Şti. enerji sektöründe sahip olduğu bilgi, tecrübe ve deneyimleriyle siz değerli çözüm ortaklarına uygun fiyat ve kaliteli ürün sunmayı ilke edinmiş olup, bu doğrultuda çalışmalarına devam etmektedir.

Güvenilirlik ilkesine bağlı birçok yenilikler ve çalışmalar ortaya koymuş olan firmamız bundan sonraki süreçte de ilkelerinden taviz vermeden alanındaki çalışmalarını genişleterek devam etmeyi hedeflemektedir.

Bizlere bu yolda yardımcı olan siz değerli çözüm ortaklarımız ve bayiliğini yaptığımız firmalara teşekkür ederiz.

Saygılarımızla,

SOLMAZSAN®



İNDEKS

- 4 BUAT İÇİ BAĞLANTI KLEMENSLERİ
- 7 HAVAI HAT BAĞLANTI KLEMENSLERİ ve O.G. SİGORTALAR
- 10 KABLO PAPUCU ve EK MUFLAR
- 13 PANO İÇİ DAĞITIM ve BAĞLANTI KLEMENSLERİ
- 18 KABLO YÜKSÜKLERİ ve UÇLARI
- 22 KABLO BAĞLARI ve ETİKETLERİ
- 25 PANO AKSESUARLARI ve BANTLAR
- 29 BUTON ve AKSESUARLARI
- 32 SİVİÇLER, VİNÇ KUMANDA BUTONLARI ve PEDALLAR
- 35 MESNET İZOLATÖRLERİ
- 37 EL ALETLERİ
- 39 OTOMATİK BASINÇ KONTROL SİSTEMLERİ ve FLATÖRLER
- 42 KAUÇUK FİŞ - PRİZ ve AKSESUARLARI
- 45 REÇİNELİ ve ISI BÜZÜŞMELİ KABLO EK MUFLARI
- 48 MOTORLU SİREN ve İKAZ LAMBALARI



"yeni nesil bağlantı"

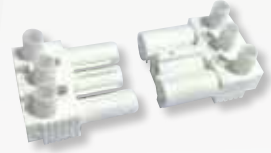
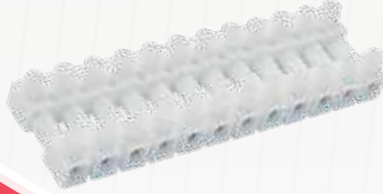

BUAT İÇİ BAĞLANTI KLEMENSLERİ

GEÇMELİ BUAT KLEMENSLER

ÜRÜN KODU	KABLO KESİTİ	BAĞLANTI	KUTU ADEDİ	₺ / ADET
SK 8310	2,5 mm ²	2	600	0,77
SK 8311	2,5 mm ²	3	600	0,88
SK 8312	2,5 mm ²	4	300	1,10
SK 8313	2,5 mm ²	5	300	1,20
SK 8315	2,5 mm ²	6	300	1,85
SK 8314	2,5 mm ²	8	200	2,40



AÇ - KAPA BUAT KLEMENSLER

ÜRÜN KODU	KABLO KESİTİ	BAĞLANTI	KUTU ADEDİ	₺ / ADET
SK 8840	2,5 mm ²	2	300	1,65
SK 8842	2,5 mm ²	3	200	2,15
SK 8843	2,5 mm ²	4	150	2,95
SK 8844	2,5 mm ²	5	150	3,45



VİDALI BUAT İÇİ ŞEFFAF KLEMENS

ÜRÜN KODU	BOY	CİNSİ	KUTU ADEDİ	₺ / ADET
SK 5504	No 1	2,5-4 mm ²	500	0,71
SK 5514	No 2	4-6 mm ²	500	0,76
SK 5524	No 3	6-10 mm ²	500	1,45
SK 5534	No 4	10-16 mm ²	500	1,40
SK 5544	No 5	16-25 mm ²	500	2,10
SK 5554	No 6/7	25-35 mm ²	200	4,80



VİDALI YİVLİ BUAT İÇİ KLEMENS

ÜRÜN KODU	RENK	A	B	C	D	E	KUTU ADEDİ	₺ / ADET
SK - P1	●	3,8	6,7	8,6	5,8	15,2	1000	0,25
SK - P2	●	4,1	7,0	9,8	5,9	17,6	1000	0,28
SK - P3	●	5,0	9,9	12,2	7,8	22,0	500	0,38
SK - P4	●	6,0	11,2	14,0	7,9	24,0	500	0,64
SK - P5	●	7,5	13,0	16,4	9,15	26,5	500	0,78



PLASTİK SIRA KLEMENSLER (EKO) M8 Prinç

ÜRÜN KODU	BOY	KABLO KESİTİ	BAĞLANTI	AMPER	KUTU ADEDİ	₺ / ADET
SK 101 E	No 1	2,5 - 4 mm ²	12	32	50	5,20
SK 102 E	No 2	4 - 6 mm ²	12	41	50	6,30
SK 103 E	No 3	6 - 10 mm ²	10	57	50	7,85
SK 104 E	No 4	10 - 16 mm ²	6	76	50	10,50
SK 105 E	No 5	16 - 25 mm ²	6	101	50	12,30



ISIYA DAYANIKLI PLASTİK SIRA KLEMENSLER (EKO) M8 Prinç

ÜRÜN KODU	BOY	KABLO KESİTİ	BAĞLANTI	AMPER	KUTU ADEDİ	₺ / ADET
SK 201 E	No 1	2,5 - 4 mm ²	12	32	50	5,65
SK 202 E	No 2	4 - 6 mm ²	12	41	50	7,00
SK 203 E	No 3	6 - 10 mm ²	10	57	50	8,95
SK 204 E	No 4	10 - 16 mm ²	6	76	50	11,30
SK 205 E	No 5	16 - 25 mm ²	6	101	50	13,80



PLASTİK SIRA KLEMENSLER M8 Prinç



ÜRÜN KODU	BOY	KABLO KESİTİ	BAĞLANTI	AMPER	KUTU ADEDİ	₺ / ADET
SK 101	No 1	2,5 - 4 mm ²	12	32	50	5,55
SK 102	No 2	4 - 6 mm ²	12	41	50	7,55
SK 103	No 3	6 - 10 mm ²	10	57	50	10,50
SK 104	No 4	10 - 16 mm ²	6	76	50	12,60
SK 105	No 5	16 - 25 mm ²	6	101	50	15,50

ISIYA DAYANIKLI PLASTİK SIRA KLEMENSLER M8 Prinç



ÜRÜN KODU	BOY	KABLO KESİTİ	BAĞLANTI	AMPER	KUTU ADEDİ	₺ / ADET
SK 201	No 1	2,5 - 4 mm ²	12	32	50	5,98
SK 202	No 2	4 - 6 mm ²	12	41	50	8,50
SK 203	No 3	6 - 10 mm ²	10	57	50	11,50
SK 204	No 4	10 - 16 mm ²	6	76	50	14,00
SK 205	No 5	16 - 25 mm ²	6	101	50	17,50

GEÇMELİ SOKET KLEMENSLER



ÜRÜN KODU	AÇIKLAMA	KUTU ADEDİ	₺ / ADET
5068	2'li Geçmeli Soket Klemens - Beyaz	50	7,50
5042	2'li Geçmeli Soket Klemens - Siyah	50	7,50
5065	3'lü Geçmeli Soket Klemens - Beyaz	50	10,50
5411	3'lü Geçmeli Soket Klemens - Siyah	50	10,50
SK-5060B	12'li Geçmeli Soket Klemens - Beyaz	25	31,00
SK-5060S	12'li Geçmeli Soket Klemens - Siyah	25	31,00

AYDINLATMA DİREK KLEMENSİ Yeni



ÜRÜN KODU	AÇIKLAMA	KUTU ADEDİ	₺ / ADET
92896	Aydınlatma direk içi klemens 1 x (1.5-6) 2 x (16-35)mm	100	13,50

PORSELEN KLEMENSLER



ÜRÜN KODU	AÇIKLAMA	KUTU ADEDİ	₺ / ADET
SK 601	NO : 1, 2'li lüster	144	2,40
SK 602	NO : 1, 3'lü lüster	80	2,97
SK 603	NO : 2, 2'li lüster	84	2,97
SK 604	NO : 2, 3'lü lüster	48	4,10
SK 605	NO : 3, 2'li lüster	50	4,10
SK 606	NO : 3, 3'lü lüster	30	6,00
SK 607	NO : 1, 1'li lüster	120	2,10
SK 609	NO : 3, 1'li lüster	100	3,80
SK 610	NO : 4, 2'li lüster	40	5,98



HAVAİ HAT BAĞLANTI KLEMENSLERİ
& O.G. SİGORTALAR

Yeni



HAVAI HAT KLEMENSİ

ÜRÜN KODU	KABLO KESİTİ	KUTU ADEDİ	₺ / ADET
92950	İzoleli klemens Al 95-35mm, Cu 2.5-50 mm	50	Fiyat Sorunuz
95951	İzoleli klemens Al 150-50mm, Cu 16-95 mm	50	

ALÜMİNYUM BAKIR AL/CU KLEMENSLER

Yeni

ÜRÜN KODU	CİNSİ	SIKMA SAHASI (mm)	İLETKEN	KUTU ADEDİ	₺ / ADET
92980	A50 B25	6-50Al/1,5-25Cu	Rose, Lily, Swallow, Sparrow	100	13,50
92982	A120 B50	16-120Al/10-70Cu	Rose, Lily, Swallow, Sparrow, Pansy, Aster, Phlox, Oxlip, Raven, Pigeon	50	24,00
92984	A240 B120	70-240Al/70-240Cu	Daisy, Peony, Tulip, Canna, Patridge, Ostrich, Hawk	25	71,50

ALÜMİNYUM /ALÜMİNYUM PARALEL KLEMENSLER (Branşman - Atlama)

Yeni

ÜRÜN KODU	CİNSİ	SIKMA SAHASI (mm)	İLETKEN	KUTU ADEDİ	₺ / ADET
92960	A50 A50	6-50Al/6-50 Al	Rose, Lily, Swallow, Sparrow	100	9,00
92962	A120 A120	16-120Al/16-120Al	Pansy, Aster, Phlox, Oxlip, Raven	50	25,00
92964	A240 A240	70-240Al/70-240Al	Daisy, Peony, Tulip, Canna, Patridge, Ostrich, Hawk	25	57,00

YENİ DURDURUCU KLEMENS

Yeni

ÜRÜN KODU	CİNSİ	SIKMA SAHASI (mm)	İLETKEN	KUTU ADEDİ	₺ / ADET
92970	A16 A120	16-120Al/16-120Al	Rose, Lily, Swallow, Sparrow	100	13,50

AL-CU KLEMENSLER

ÜRÜN KODU	SIKMA SAHASI (mm)	İLETKEN	KUTU ADEDİ	₺ / ADET
A25B16 TSE	6-25Al/2,5-16Cu	Rose	100	9,00
A40B25 TSE	16-40Al/10-25Cu	Rose, Lily, Swallow, Sparrow	100	11,15
A70B50 TSE	16-70Al/10-50Cu	Rose, Lily, Swallow, Sparrow	50	19,00
A120B70 TSE	7-120Al/10/70Cu	Pansy, Aster, Phlox, Oxlip, Raven, Pigeon	50	33,00
A240B120 TSE	7-240Al/50-120Cu	Daisy, Peony, Tulip, Canna, Patridge, Ostrich, Hawk	25	71,60
A240B240 TSE	240Al/240Cu	Daisy, Peony, Tulip, Canna, Patridge, Ostrich, Hawk	25	115,00

ALÜMİNYUM PARALEL KLEMENSLER (Branşman-Atlama)

ÜRÜN KODU	SIKMA SAHASI (mm)	İLETKEN	KUTU ADEDİ	₺ / ADET
A16A16 TSE	6-16	Rose	100	5,67
A25A25 TSE	16-25	Rose	50	5,80
A40A40 TSE	16-40	Rose, Lily, Swallow, Sparrow	25	9,00
A70A70 TSE	16-70	Rose, Lily, Pansy, Swallow, Sparrow	50	14,70
A120A120 TSE	40-120	Pansy, Aster, Phlox, Oxlip, Raven	50	25,20
A240A240 TSE	70-240	Daisy, Peony, Tulip, Canna, Patridge, Ostrich, Hawk	50	57,30

DURDURUCU KLEMENSLER

ÜRÜN KODU	SIKMA SAHASI (mm)	İLETKEN	KUTU ADEDİ	₺ / ADET
A16A50 TSE	16-50	Rose, Lily, Swallow, Sparrow	100	13,30
A50A95 TSE	50-95	Rose, Lily, Swallow, Sparrow	50	24,00



AL-CU KLEMENS (EKO)

ÜRÜN KODU	KESİT (mm ²)	İLETKEN	KUTU ADEDİ	₺ / ADET
A25B16	25 Al - 16 Cu	Rose	100	6,75
A40B25	40 Al - 25 Cu	Rose, Lily, Swallow, Sparrow	100	7,95
A70B50	70 Al - 50 Cu	Rose, Lily, Swallow, Sparrow	50	12,00
A120B70	120 Al - 70 Cu	Pansy, Aster, Phlox, Raven	50	21,30
A40A40	40 Al - 40 Al	Rose, Lily, Swallow, Sparrow	100	5,60
A70A70	70 Al - 70 Al	Rose, Lily, Pansy, Swallow, Sparrow	50	9,75
A120A120	120 Al - 120 Al	Rose, Lily, Pansy, Swallow, Sparrow	50	14,40
A16A50	16 Al - 50 Al	Rose, Lily, Swallow, Sparrow	50	9,75
A50A95	50 Al - 95 Al	Rose, Lily, Swallow, Sparrow	50	14,00



MAKARA İZOLATÖRÜ ve AKSESUARLARI

ÜRÜN KODU	AÇIKLAMA	KUTU ADEDİ	₺ / ADET
BEM0001	Makara İzolatörü	60	24,00
BEM0002	İM 22 Mil	60	15,00
BEM0003	ÖD 85 Özengi Demiri	60	17,00
BEM0004	AK 100 Askı Kancası	60	18,75
BEM0008	E-80 İzolatör	90	16,35
BEM0009	E-80 İzolatör Demiri	90	14,55
BEM0010	D-80 Deve Boynu İzolatör Demiri	90	19,00
BEM0011	Makara İzolatör Takım	60	75,00



TIRNAKLI KLEMENS

ÜRÜN KODU	BOY	İLETKEN KESİTİ (mm ²)	KUTU ADEDİ	₺ / ADET
92701	No 1	4-6 mm ²	50	6,40
92702	No 2	16-25 mm ²	50	6,60
92703	No 3	25-35 mm ²	50	9,60
92704	No 4	35-50 mm ²	50	11,00
92705	No 5	50-70 mm ²	50	18,75
92707	No 6-7	70-95 mm ²	50	30,75



U KLEMENSLER

ÜRÜN KODU	AÇIKLAMA	KUTU ADEDİ	₺ / ADET
SK 7050	6 mm ² U klemens	150	2,65
SK 7051	10 mm ² U klemens	125	4,25
SK 7052	16 mm ² U klemens	100	6,10
SK 7053	25 mm ² U klemens	100	7,00
SK 7054	35 mm ² U klemens	75	8,50
SK 7055	50 mm ² U klemens	50	14,00
SK 7056	70 mm ² U klemens	40	15,50
SK 7057	95 mm ² U klemens	25	21,50
SK 7058	120 mm ² U klemens	20	26,00
SK 7059	150 mm ² U klemens	15	37,00



O.G. SİGORTA

ÜRÜN KODU	AÇIKLAMA	KUTU ADEDİ	₺ / ADET
OG61	61 cm O.G. Sigorta (6.....50A) 36kV	12	Fiyat Sorunuz
OG51	51 cm O.G. Sigorta (6.....50A) 24kV	12	



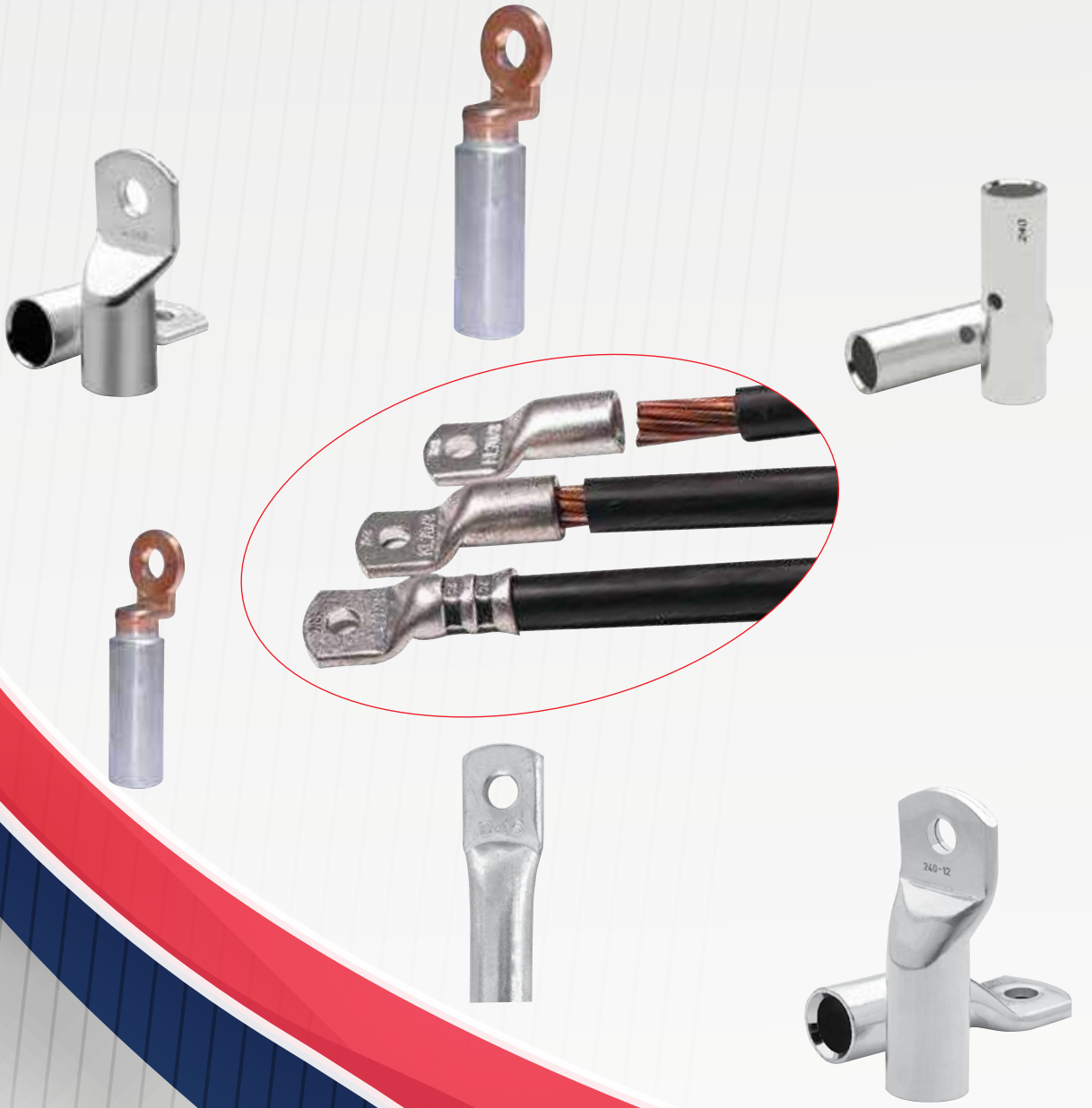

KABLO PAPUCU & EK MUFLAR

EKO SKP (Kısa Tip) (BAKIR İLETKEN)

ÜRÜN KODU	KESİT	METRİK	d	d1	d2	l	l1	a	b	c1	c2	K.AD.	₺ / ADET
SK 6027	16 mm ²	M6	6,5	5,6	7,8	29,5	24,0	12,0	11,2	5,5	6,5	500	0,99
SK 6028	25 mm ²	M8	8,5	7,1	9,5	39,0	32,2	16,0	13,7	6,8	9,2	300	2,16
SK 6029	35 mm ²	M8	8,5	8,2	10,8	44,0	35,7	19,0	15,3	8,3	9,7	200	2,88
SK 6030	50 mm ²	M10	10,5	10,1	13,0	51,5	41,5	21,0	18,9	10,0	12,0	125	3,60
SK 6031	70 mm ²	M10	10,5	11,5	14,7	54,6	44,6	23,0	21,1	10,0	12,0	100	5,95
SK 6032	95 mm ²	M12	13,0	13,5	16,7	58,8	49,8	26,0	24,7	10,0	12,0	75	6,85
SK 6033	120 mm ²	M12	13,0	15,6	19,0	69,0	56,0	29,0	27,7	13,0	14,5	50	9,75
SK 6034	150 mm ²	M12	13,0	16,5	21,0	76,5	60,0	30,0	30,4	16,5	16,5	40	15,50
SK 6035	185 mm ²	M14	15,0	18,4	23,0	82,5	65,5	33,0	34,2	17,0	18,0	25	18,55
SK 6036	240 mm ²	M14	15,0	21,0	26,0	89,	72,0	38,0	38,7	17,0	18,0	20	27,00
SK 6037	300 mm ²	M16	16,0	21,0	27,0	91,0	72,0	39,0	40,0	17,0	18,0	20	32,50

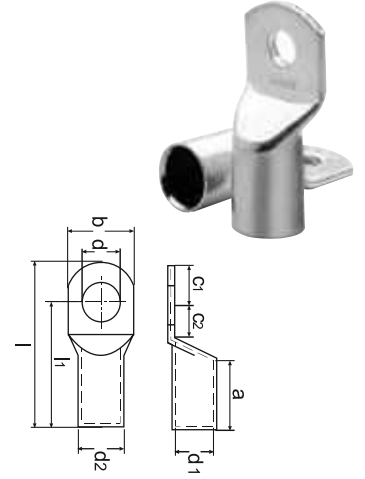

STANDART SKP (Uzun ve Kalın Tip) (BAKIR İLETKEN)

ÜRÜN KODU	KESİT	METRİK	d	d1	d2	l	l1	a	b	c1	c2	K.AD.	₺ / ADET
SK 6025/S	6 mm ²	M5	5,5	5,5	6,6	27,5	22,0	10,0	10,3	5,5	7,0	1000	0,95
SK 6026/S	10 mm ²	M5	5,5	4,7	6,6	27,5	22,0	10,0	10,3	5,5	7,0	800	1,20
SK 6026/M8	10 mm ²	M8	8,5	4,7	6,6	30,5	23,7	10,0	13,5	6,8	8,7	800	1,35
SK 6027/S	16 mm ²	M6	6,5	5,6	7,8	29,5	24,0	12,0	11,2	5,5	6,5	500	1,75
SK 6027/M8	16 mm ²	M8	8,5	5,6	7,8	33,0	26,2	12,0	13,5	6,8	8,7	500	1,95
SK 6028/S	25 mm ²	M8	8,5	7,1	9,5	39,0	32,2	16,0	13,7	6,8	9,2	275	2,90
SK 6029/S	35 mm ²	M8	8,5	8,2	10,8	44,0	35,7	19,0	15,3	8,3	9,7	175	3,95
SK 6030/S	50 mm ²	M10	10,5	10,1	13,0	51,5	41,5	21,0	18,9	10,0	12,0	100	7,10
SK 6031/S	70 mm ²	M10	10,5	11,5	14,7	54,6	44,6	23,0	21,1	10,0	12,0	90	8,00
SK 6032/S	95 mm ²	M12	13,0	13,5	16,7	58,8	49,8	26,0	24,7	10,0	12,0	60	9,80
SK 6033/S	120 mm ²	M12	13,0	15,6	19,0	69,0	56,0	29,0	27,7	13,0	14,5	50	14,00
SK 6034/S	150 mm ²	M12	13,0	16,5	21,0	76,5	60,0	30,0	30,4	16,5	16,5	30	22,50
SK 6035/S	185 mm ²	M14	15,0	18,4	23,0	82,5	65,5	33,0	34,2	17,0	18,0	25	26,00
SK 6036/S	240 mm ²	M14	15,0	21,0	26,0	89,	72,0	38,0	38,7	17,0	18,0	20	36,00
SK 6037/S	300 mm ²	M16	16,0	21,0	27,0	91,0	72,0	39,0	39,5	17,0	18,0	20	45,50

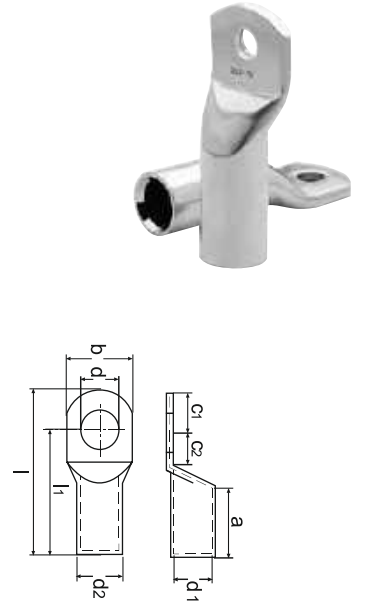

AL-CU SKP (BİMETAL)

ÜRÜN KODU	KESİT	METRİK	L	B	K.AD.	₺ / ADET
TBF-16	16 mm ²	M8	84	16	100	20,50
TBF-25	25 mm ²	M8	84	25	100	20,50
TBF-35	35 mm ²	M8	84	35	100	21,50
TBF-50	50 mm ²	M10	84	50	50	28,00
TBF-70	70 mm ²	M10	84	70	50	28,00
TBF-95	95 mm ²	M12	84	95	50	29,00
TBF-120	120 mm ²	M12	107	120	30	45,00
TBF-150	150 mm ²	M12	107	150	30	45,00
TBF-185	185 mm ²	M16	117	185	20	74,50
TBF-240	240 mm ²	M16	117	240	20	74,50

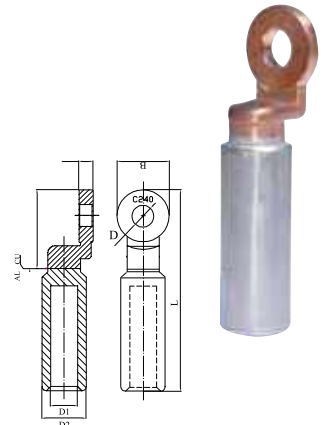

ALÜMİNYUM SKP (ALÜMİNYUM İLETKEN)

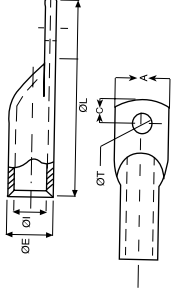

ÜRÜN KODU	KESİT	METRİK	L	K.AD.	₺ / ADET
SKP-AL10	10 mm ²	M6	50	500	1,95
SKP-AL16	16 mm ²	M6	56	300	2,00
SKP-AL25	25 mm ²	M8	64	150	2,50
SKP-AL35	35 mm ²	M10	73	100	3,60
SKP-AL50	50 mm ²	M10	81	75	4,55
SKP-AL70	70 mm ²	M10	94	50	6,00
SKP-AL95	95 mm ²	M12	102	50	7,50
SKP-AL120	120 mm ²	M12	112	20	9,00
SKP-AL150	150 mm ²	M14	114	20	14,00
SKP-AL185	185 mm ²	M14	125	20	16,00
SKP-AL240	240 mm ²	M14	141	12	18,50

SEM EK MUFLARI (BAKIR İLETKEN)

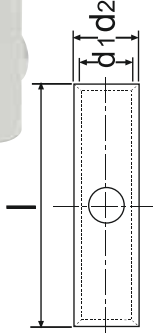

ÜRÜN KODU	KESİT	d1	d2	l	K.AD.	₺ / ADET
SK 7062	16 mm ²	5,6	7,8	32,0	500	1,50
SK 7063	25 mm ²	7,1	9,5	40,5	350	2,35
SK 7064	35 mm ²	8,2	10,8	45,5	200	3,25
SK 7065	50 mm ²	10,1	13,0	53,5	150	4,35
SK 7066	70 mm ²	11,5	14,7	57,5	100	7,38
SK 7067	95 mm ²	13,5	16,7	61,5	80	9,00
SK 7068	120 mm ²	15,6	19,0	74,0	50	10,80
SK 7069	150 mm ²	16,5	21,0	79,0	40	19,00
SK 7070	185 mm ²	18,4	23,0	85,0	30	22,60
SK 7071	240 mm ²	21,0	26,0	94,0	25	32,50

SEM EK MUFLARI (ALÜMİNYUM İLETKEN)

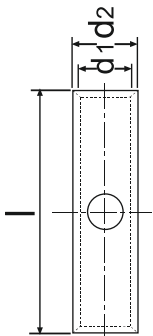

ÜRÜN KODU	KESİT	d1	d2	l	K.AD.	₺ / ADET
SK 7062-A	16 mm ²	5,6	7,8	32,0	200	1,80
SK 7063-A	25 mm ²	7,1	9,5	40,5	125	2,50
SK 7064-A	35 mm ²	8,2	10,8	45,5	100	3,40
SK 7065-A	50 mm ²	10,1	13,0	53,5	75	4,50
SK 7066-A	70 mm ²	11,5	14,7	57,5	50	5,90
SK 7067-A	95 mm ²	13,5	16,7	61,5	40	7,40
SK 7068-A	120 mm ²	15,6	19,0	74,0	25	8,80
SK 7069-A	150 mm ²	16,5	21,0	79,0	20	11,10
SK 7070-A	185 mm ²	18,4	23,0	85,0	15	15,80
SK 7071-A	240 mm ²	21,0	26,0	94,0	15	18,00

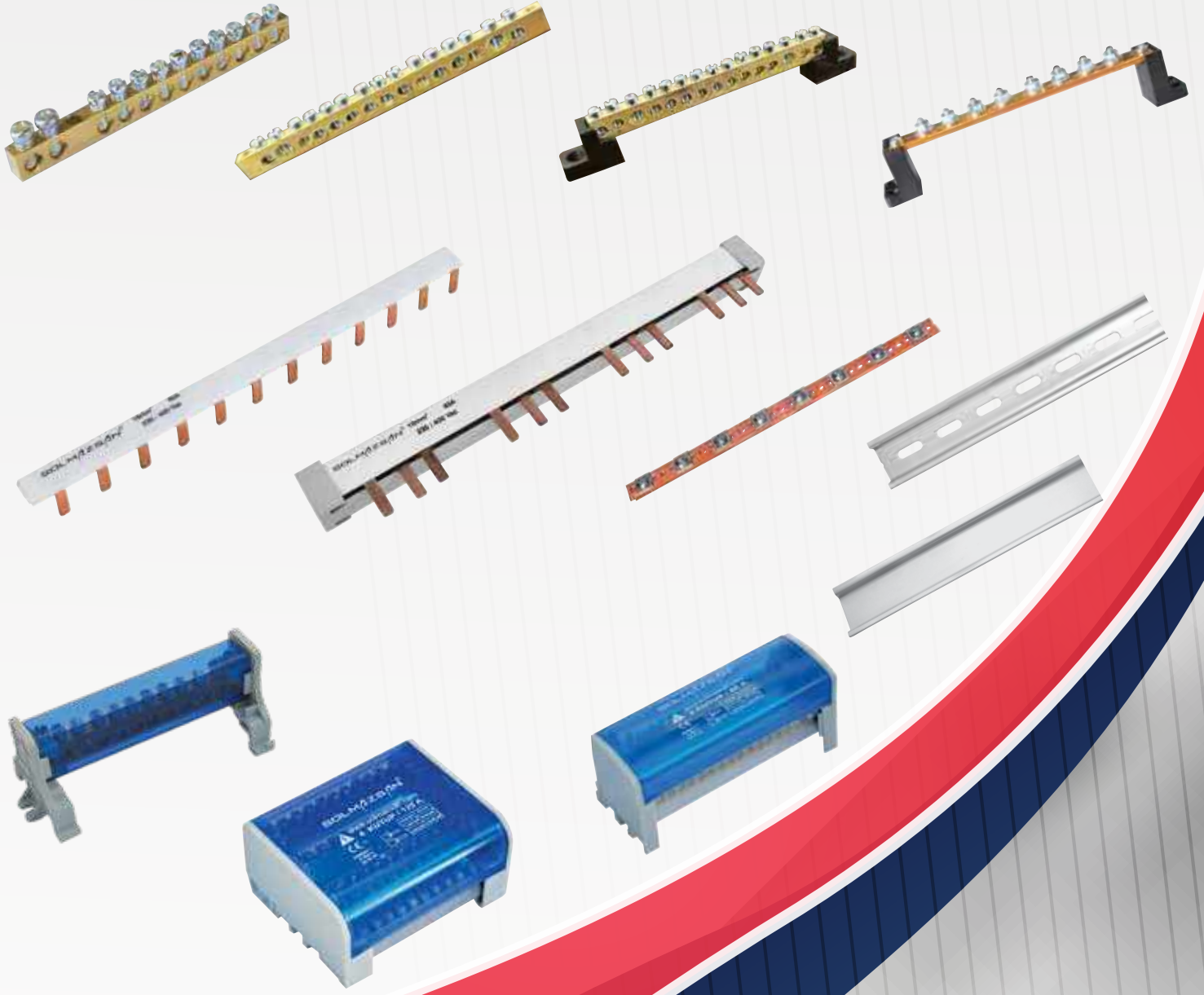

PANO İÇİ DAĞITIM &
BAĞLANTI KLEMENSLERİ

TRİFAZE MÜŞTEREK W OTOMAT BARASI

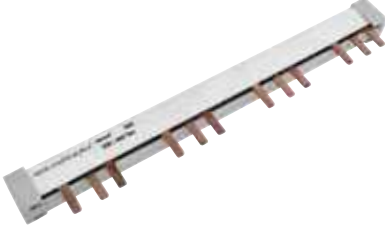

ÜRÜN KODU	ÖLÇÜ	AKIM (A)	MODÜL	KOLİ ADEDİ	₺ / ADET
SK 3044	53 cm	80 (1 mm)	10	25	51,50
SK 3054	53 cm	100 (1,5 mm)	10	25	86,00
SK 3045	106 cm	80 (1 mm)	20	25	103,00
SK 3055	106 cm	100 (1,5 mm)	20	25	172,00

MONOFAZE MÜŞTEREK W OTOMAT BARASI

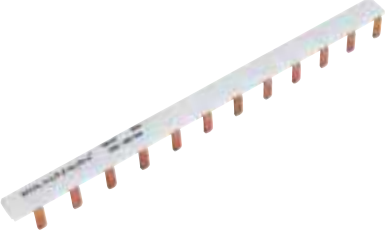

ÜRÜN KODU	ÖLÇÜ	AKIM (A)	MODÜL	KOLİ ADEDİ	₺ / ADET
SK 3005	53 cm	63 (1 mm)	30	50	20,50
SK 3006	100 cm	63 (1 mm)	30	50	41,00
SK 3015	106 cm	100 (1,5 mm)	60	50	67,50

NÖTR TOPRAKLAMA BARASI

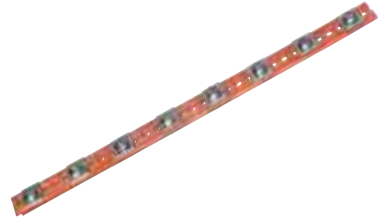

ÜRÜN KODU	ÖLÇÜ	AKIM (A)	MODÜL	KOLİ ADEDİ	₺ / ADET
SK 3075	15 x 1,5	100	31	40	62,50
SK 3076	15 x 1,5	100	61	40	76,50
SK 3085	15 x 2,0	100	31	40	79,50
SK 3086	15 x 2,0	100	61	40	93,75
SK 3087	15 x 3,0	100	61	40	137,00

35 x 7,5 mm SAC MONTAJ RAYLARI



ÜRÜN KODU	ÖLÇÜ	AÇIKLAMA	KOLİ ADEDİ	₺ / ADET
SK 4001	30 cm	Düz W otomat rayı	50	2,50
SK 4002	100 cm	Düz W otomat rayı	50	7,80
SK 4003	200 cm	Düz W otomat rayı	25	15,60
SK 4011	30 cm	Delikli W otomat rayı	50	2,50
SK 4012	100 cm	Delikli W otomat rayı	50	7,80
SK 4013	200 cm	Delikli W otomat rayı	25	15,60

*İstenilen ölçüde ray kesilebilir.

PANO TOPRAKLAMA KLEMENSİ - AYAKSIZ (6 x 8 mm) 63 A

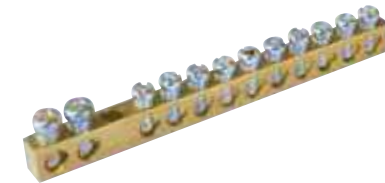

ÜRÜN KODU	AÇIKLAMA	L	B	H	KOLİ ADEDİ	₺ / ADET
SK 1004	2/2 4 delikli	33	6,5	9	100	3,10
SK 1005	2/3 5 delikli	38	6,5	9	100	3,30
SK 1006	2/4 6 delikli	45	6,5	9	100	4,30
SK 1007	2/5 7 delikli	50	6,5	9	100	4,50
SK 1009	2/7 9 delikli	62	6,5	9	100	5,00
SK 1010	2/8 10 delikli	68	6,5	9	100	5,35
SK 1012	2/10 12 delikli	80	6,5	9	100	6,50
SK 1022	2/20 22 delikli	133	6,5	9	50	12,50
SK 909	2/40 42 delikli	274	6,5	9	50	
SK 910	2/60 62 delikli	395	6,5	9	50	
SK 911	2/80 82 delikli	520	6,5	9	50	

Fiyat Sorunuz

PANO TOPRAKLAMA KLEMENSİ - AYAKSIZ (6,5 x 9 mm) 80 A

ÜRÜN KODU	AÇIKLAMA	L	L2	B	H	KOLİ ADEDİ	₺ / ADET
SK 1206	6 delikli	65	50	6,5	9	50	7,60
SK 1207	7 delikli	71	56	6,5	9	50	8,40
SK 1210	10 delikli	88	73	6,5	9	50	9,90
SK 1212	12 delikli	100	85	6,5	9	50	11,00
SK 1215	15 delikli	118	103	6,5	9	50	13,40
SK 1220	20 delikli	146	133	6,5	9	50	17,50
SK 1225	25 delikli	177	162	6,5	9	50	20,75
SK 1230	30 delikli	206	191	6,5	9	50	30,50

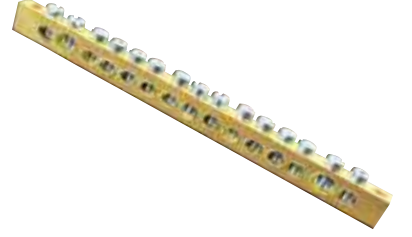

PANO TOPRAKLAMA KLEMENSİ - AYAKSIZ (7x 12 mm) 125 A

ÜRÜN KODU	AÇIKLAMA	L	L2	B	H	KOLİ ADEDİ	₺ / ADET
SK 1306	6 delikli	65	50	7	12	50	10,00
SK 1307	7 delikli	71	56	7	12	50	10,75
SK 1310	10 delikli	88	73	7	12	50	13,30
SK 1312	12 delikli	100	85	7	12	50	16,50
SK 1315	15 delikli	118	103	7	12	50	20,50
SK 1320	20 delikli	146	133	7	12	50	26,00
SK 1325	25 delikli	177	162	7	12	50	30,50
SK 1330	30 delikli	206	191	7	12	50	39,10

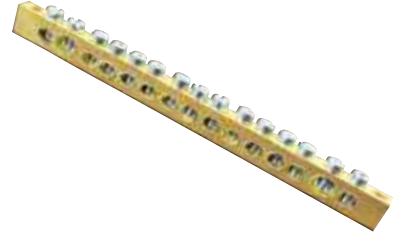

TEK KUTUPLU DAĞITICI ÜNİTE (6,5 x 9 mm) 80 A

ÜRÜN KODU	AÇIKLAMA	L	L2	H	KOLİ ADEDİ	₺ / ADET
SK 1106/A	6 delikli, ayaklı	100	87	22	50	8,10
SK 1107/A	7 delikli, ayaklı	106	93	22	50	8,90
SK 1110/A	10 delikli, ayaklı	124	100	22	50	10,40
SK 1112/A	12 delikli, ayaklı	135	124	22	50	11,50
SK 1115/A	15 delikli, ayaklı	155	142	22	50	13,90
SK 1120/A	20 delikli, ayaklı	186	173	22	50	18,00
SK 1125/A	25 delikli, ayaklı	218	205	22	50	21,25
SK 1130/A	30 delikli, ayaklı	245	232	22	50	31,00

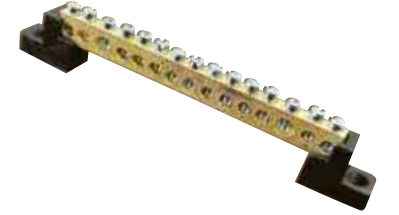

TEK KUTUPLU DAĞITICI ÜNİTE (7 x 12 mm) 125 A

ÜRÜN KODU	AÇIKLAMA	L	L2	H	KOLİ ADEDİ	₺ / ADET
SK 1306/A	6 delikli, ayaklı	104	70	22	50	10,50
SK 1307/A	7 delikli, ayaklı	104	91	22	50	11,25
SK 1310/A	10 delikli, ayaklı	128	115	22	50	13,80
SK 1312/A	12 delikli, ayaklı	145	130	22	50	17,00
SK 1315/A	15 delikli, ayaklı	162	150	22	50	21,00
SK 1320/A	20 delikli, ayaklı	200	187	22	50	26,00
SK 1325/A	25 delikli, ayaklı	238	225	22	50	31,00
SK 1330/A	30 delikli, ayaklı	275	262	22	50	39,60

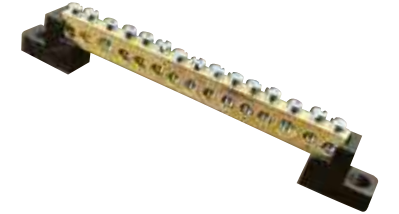

EŞ POTANSİYEL BARA 5x20 mm 250A (PLASTİK AYAK)

ÜRÜN KODU	AÇIKLAMA	L	B	H	KOLİ ADEDİ	₺ / ADET
SK 3708	1 giriş 7 çıkış	220	-	39	1	66,50
SK 3711	1 giriş 10 çıkış	270	-	39	1	82,00
SK 3715	1 giriş 14 çıkış	345	-	39	1	102,50

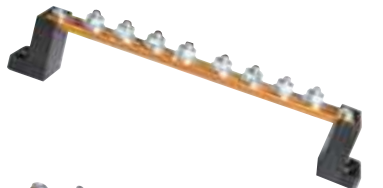

EŞ POTANSİYEL BARA 5x20 mm 250A (İZOLATÖR AYAK)

ÜRÜN KODU	AÇIKLAMA	L	B	H	KOLİ ADEDİ	₺ / ADET
SK 3608	1 giriş 7 çıkış	200	-	45	1	82,00
SK 3611	1 giriş 10 çıkış	260	-	45	1	95,00
SK 3615	1 giriş 14 çıkış	335	-	45	1	122,00

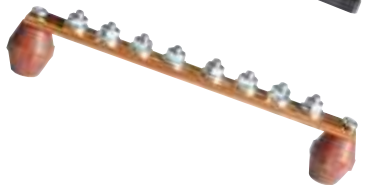

35 x 7,5 mm RAYA GEÇMELİ TEK KUTUPLU ÜNİTE KAPAKLI 80A



ÜRÜN KODU	AÇIKLAMA	L	B	H	KOLİ ADEDİ	₺ / ADET
SK 1806	2/4 - 6 Delikli	60	44	42	25	14,00
SK 1807	2/5 - 7 Delikli	66	44	42	25	15,25
SK 1810	2/8 - 10 Delikli	82	44	42	25	20,00
SK 1812	2/10 - 12 Delikli	100	44	42	25	24,00
SK 1815	2/13 - 15 Delikli	115	44	42	25	30,00
SK 1820	2/18 - 20 Delikli	142	44	42	25	34,50
SK 1825	2/23 - 25 Delikli	175	44	42	25	43,00
SK 1830	2/28 - 30 Delikli	215	44	42	25	59,50

2 KUTUPLU DAĞITICI ÜNİTE (6,5 x 9 mm) 80 A



ÜRÜN KODU	AÇIKLAMA	L	B	H	KUTU ADEDİ	₺ / ADET
SK 1407/80	2/5 7 delikli	65	45	47	1	31,00
SK 1410/80	2/8 10 delikli	88	45	47	1	38,00
SK 1412/80	2/10 12 delikli	102	45	47	1	43,00
SK 1415/80	2/13 15 delikli	126	45	47	1	52,00
SK 1420/80	2/18 20 delikli	162	45	47	1	70,00
SK 1422/80	2/20 22 delikli	175	45	47	1	78,00

2 KUTUPLU DAĞITICI ÜNİTE (7 x 12 mm) 125 A

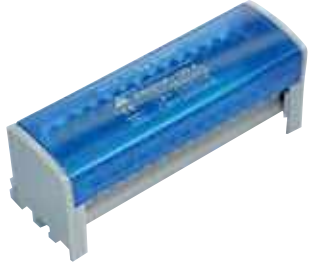

ÜRÜN KODU	AÇIKLAMA	L	B	H	KUTU ADEDİ	₺ / ADET
SK 1407	2/5 7 delikli	65	45	47	1	37,00
SK 1410	2/8 10 delikli	88	45	47	1	47,50
SK 1412	2/10 12 delikli	102	45	47	1	50,50
SK 1415	2/13 15 delikli	126	45	47	1	64,50
SK 1420	2/18 20 delikli	162	45	47	1	82,00
SK 1422	2/20 22 delikli	175	45	47	1	86,50

4 KUTUPLU DAĞITICI ÜNİTE (6,5 x 9 mm) 80 A



ÜRÜN KODU	AÇIKLAMA	L	B	H	KUTU ADEDİ	₺ / ADET
SK 1607/80	2/5 7 delikli	65	45	47	1	57,50
SK 1610/80	2/8 10 delikli	88	45	47	1	67,50
SK 1612/80	2/10 12 delikli	102	45	47	1	78,00
SK 1615/80	2/13 15 delikli	126	45	47	1	87,75
SK 1620/80	2/18 20 delikli	162	45	47	1	113,50
SK 1622/80	2/20 22 delikli	175	45	47	1	122,00

4 KUTUPLU DAĞITICI ÜNİTE (7 x 12 mm) 125 A



ÜRÜN KODU	AÇIKLAMA	L	B	H	KUTU ADEDİ	₺ / ADET
SK 1607	2/5 7 delikli	65	45	47	1	60,75
SK 1610	2/8 10 delikli	88	45	47	1	75,00
SK 1612	2/10 12 delikli	102	45	47	1	83,00
SK 1615	2/13 15 delikli	126	45	47	1	104,00
SK 1620	2/18 20 delikli	162	45	47	1	135,00
SK 1622	2/20 22 delikli	175	45	47	1	145,00

4 KUTUPLU DAĞITICI ÜNİTE (7 x 12 mm) 125 A - YÜKSEK MODEL

ÜRÜN KODU	AÇIKLAMA		L	B	H	KUTU ADEDİ	₺ / ADET
SK 1507	2/5	7 delikli	65	90	50	1	79,00
SK 1510	2/8	10 delikli	87	90	50	1	83,50
SK 1512	2/10	12 delikli	102	90	50	1	95,50
SK 1515	2/13	15 delikli	126	90	50	1	117,00
SK 1520	2/18	20 delikli	162	90	50	1	153,50
SK 1522	2/20	22 delikli	175	90	50	1	165,00
SK 1525	2/23	25 delikli	197	90	50	1	192,00

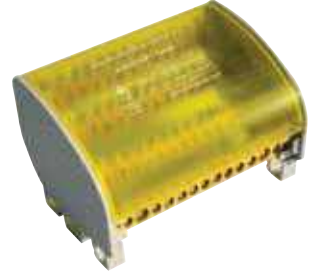

4 KUTUPLU DAĞITICI ÜNİTE (10 x 15 mm) 160 A

ÜRÜN KODU	AÇIKLAMA		L	B	H	KUTU ADEDİ	₺ / ADET
SK 3207	2/5	7 delikli	105	144	55	1	145,00
SK 3210	2/8	10 delikli	145	144	55	1	212,00
SK 3212	2/10	12 delikli	165	144	55	1	252,00
SK 3215	2/13	15 delikli	200	144	55	1	313,00
SK 3220	2/18	20 delikli	255	144	55	1	418,00
SK 3222	2/20	22 delikli	275	144	55	1	425,00



5 KUTUPLU DAĞITICI ÜNİTE (10 x 15 mm) 160 A

ÜRÜN KODU	AÇIKLAMA		L	B	H	KUTU ADEDİ	₺ / ADET
SK 3307	2/5	7 delikli	105	151	95	1	175,00
SK 3310	2/8	10 delikli	145	151	95	1	250,00
SK 3312	2/10	12 delikli	165	151	95	1	300,00
SK 3315	2/13	15 delikli	200	151	95	1	375,00
SK 3320	2/18	20 delikli	255	151	95	1	500,00
SK 3322	2/20	22 delikli	275	151	95	1	547,00



4 KUTUPLU 3x15 mm BAKIR BARALI DAĞITICI ÜNİTE 200 A

ÜRÜN KODU	AÇIKLAMA		L	B	H	KUTU ADEDİ	₺ / ADET
SK 3508	1 giriş	7 çıkış	220	150	95	1	231,00
SK 3511	1 giriş	10 çıkış	280	150	95	1	260,00
SK 3515	1 giriş	14 çıkış	354	150	95	1	302,00



4 KUTUPLU 5x20 mm BAKIR BARALI DAĞITICI ÜNİTE 250 A

ÜRÜN KODU	AÇIKLAMA		L	B	H	KUTU ADEDİ	₺ / ADET
SK 3408	1 giriş	7 çıkış	220	150	95	1	266,00
SK 3411	1 giriş	10 çıkış	280	150	95	1	305,00
SK 3415	1 giriş	14 çıkış	354	150	95	1	333,00



KABLO YÜKSÜKLERİ & UÇLARI

TEK GİRİŞLİ İZOLELİ KABLO YÜKSÜKLERİ (BAKIR İLETKEN)

ÜRÜN KODU	RENK	KABLO KESİTİ	ÖLÇÜ						KUTU ADEDİ	₺ / ADET
			F	L	W	B	D	C		
SK 8006	○ ●	0,50 mm	8,0	12,0	2,6	6,3	1,3	1,0	1000	0,065
SK 8010	○ ●	0,75 mm	8,0	14,0	2,8	6,3	1,5	1,2	1000	0,065
SK 8014	● ●	1,00 mm	8,0	14,0	3,0	6,3	1,7	1,4	1000	0,065
SK 8017	● ●	1,50 mm	8,0	14,0	3,5	6,3	2,0	1,7	1000	0,068
SK 8021	● ●	2,50 mm	8,0	14,0	4,2	7,4	2,5	2,2	500	0,080
SK 8025	● ●	4,00 mm	10,0	17,0	4,8	7,4	3,2	2,8	500	0,135
SK 8028	● ●	6,00 mm	12,0	20,0	6,3	8,5	3,9	3,5	250	0,175
SK 8030	● ●	10,0 mm	12,0	22,0	7,6	8,8	4,9	4,5	100	0,200
SK 8032	● ●	16,0 mm	12,0	24,0	8,8	10,0	6,2	5,8	100	0,285
SK 8034	● ●	25,0 mm	16,0	28,0	11,2	12,0	7,7	7,3	50	0,530
SK 8036	● ●	35,0 mm	16,0	30,0	12,7	14,0	8,7	8,3	50	0,670
SK 8039	● ●	50,0 mm	20,0	36,0	15,0	16,0	10,9	10,3	25	1,100
SK 8041	●	70,0 mm	20,0	37,0	16,0	17,0	14,3	13,5	10	2,400



Standart : DIN 46228
Malzeme : Bakır (E-Cu), Kalay Kaplı
İzolasyon : Naylon
Çalışma Sıcaklığı : max.105°C - 600V

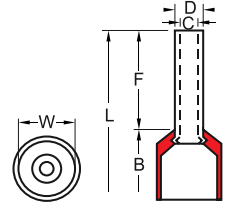

ÇİFT GİRİŞLİ İZOLELİ KABLO YÜKSÜKLERİ (BAKIR İLETKEN)

ÜRÜN KODU	RENK	KABLO KESİTİ	ÖLÇÜ						KUTU ADEDİ	₺ / ADET
			F	L	W	B	D	C		
SK 8161	○ ●	2 x 0,50 mm	8,0	14,0	5,0	6,5	1,8	1,5	1000	0,120
SK 8162	○ ●	2 x 0,75 mm	8,0	14,0	5,5	6,7	2,1	1,8	500	0,120
SK 8164	● ●	2 x 1 mm	8,0	14,0	5,5	7,1	2,4	2,1	500	0,120
SK 8166	● ●	2 x 1,5 mm	8,0	14,0	6,4	7,5	2,6	2,3	500	0,130
SK 8168	● ●	2 x 2,5 mm	10,0	14,0	8,0	8,5	3,3	2,9	250	0,180
SK 8170	● ●	2 x 4 mm	12,0	17,0	8,8	11,1	4,2	3,8	200	0,440
SK 8171	● ●	2 x 6 mm	14,0	20,0	9,5	12,1	5,3	4,9	100	0,520
SK 8172	● ●	2 x 10 mm	14,0	27,0	12,6	12,6	6,9	6,5	100	1,000
SK 8173	● ●	2 x 16 mm	14,0	31,0	19,0	17,3	8,7	8,3	50	1,000



Standart : DIN 46228
Malzeme : Bakır (E-Cu), Kalay Kaplı
İzolasyon : Naylon
Çalışma Sıcaklığı : max.105°C - 600V

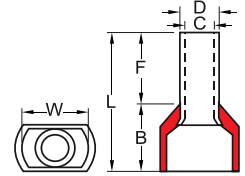

İZOLESİZ KABLO YÜKSÜKLERİ (BAKIR İLETKEN)

ÜRÜN KODU	KABLO KESİTİ	ÖLÇÜ				KUTU ADEDİ	₺ / ADET
		L	D	C	W		
SK 8100	0,50 mm	10,0	1,3	1,0	1,7	2000	0,045
SK 8101	0,75 mm	10,0	1,3	1,2	1,7	1000	0,045
SK 8102	1 mm	10,0	1,5	1,4	1,9	1000	0,045
SK 8103	1,5 mm	10,0	1,7	1,7	2,2	1000	0,052
SK 8104	2,5 mm	12,0	2,0	2,2	2,5	1000	0,074
SK 8105	4 mm	12,0	2,0	2,8	2,5	1000	0,100
SK 8106	6 mm	12,0	2,6	3,4	3,3	500	0,140
SK 8107	10 mm	15,0	2,6	4,5	3,3	250	0,220
SK 8108	16 mm	15,0	3,2	5,8	3,9	250	0,420
SK 8109	25 mm	16,0	3,9	7,3	4,7	100	0,420
SK 8110	35 mm	16,0	4,9	8,3	5,8	100	0,480
SK 8111	50 mm	20,0	4,9	10,3	5,8	50	0,930



Standart : DIN 46228
Malzeme : Bakır (E-Cu), Kalay Kaplı

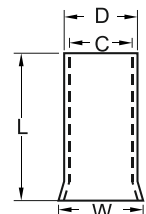

YUVARLAK TİP İZOLELİ KABLO UÇLARI (BAKIR İLETKEN)



Standart : DIN 46228
Malzeme : Bakır (E-Cu), Kalay Kaplı
İzolasyon : PVC
Çalışma Sıcaklığı : max.105°C - 600V

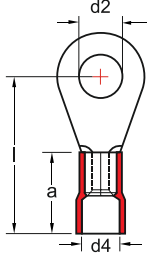

ÜRÜN KODU	RENK	KABLO KESİTİ	METRİK VİDA	ÖLÇÜ				KUTU ADEDİ	₺ / ADET
				d2	l	d4	a		
SK 8125	●	0,5 - 1,5	3	3,2	16,0	4,0	10,0	200	0,150
SK 8126	●	0,5 - 1,5	4	4,3	17,0	4,0	10,0	200	0,220
SK 8127	●	0,5 - 1,5	5	5,3	18,0	4,0	10,0	200	0,230
SK 8128	●	0,5 - 1,5	6	6,5	18,0	4,0	10,0	200	0,350
SK 8129	●	0,5 - 1,5	8	8,4	22,0	4,0	10,0	200	0,360
SK 8135	●	1,5 - 2,5	3	3,2	16,0	4,5	10,0	200	0,260
SK 8136	●	1,5 - 2,5	4	4,3	17,0	4,5	10,0	200	0,270
SK 8138	●	1,5 - 2,5	5	5,3	19,0	4,5	10,0	200	0,280
SK 8140	●	1,5 - 2,5	6	6,5	21,0	4,5	10,0	200	0,390
SK 8141	●	1,5 - 2,5	8	8,4	22,0	4,5	10,0	200	0,400
SK 8145	●	4,0 - 6,0	4	4,3	21,0	6,3	13,0	100	0,570
SK 8146	●	4,0 - 6,0	5	5,3	22,0	6,3	13,0	100	0,580
SK 8147	●	4,0 - 6,0	6	6,5	22,5	6,3	13,0	100	0,650
SK 8148	●	4,0 - 6,0	8	8,4	26,0	6,3	13,0	100	0,820
SK 8149	●	4,0 - 6,0	10	10,5	28,0	6,3	13,0	100	0,840
SK 8150	●	4,0 - 6,0	12	13,0	28,0	6,3	13,0	100	0,850

İZOLELİ ÇATAL KABLO UÇLARI (BAKIR İLETKEN)



Standart : DIN 46228
Malzeme : Bakır (E-Cu), Kalay Kaplı
İzolasyon : Naylon
Çalışma Sıcaklığı : max.105°C - 600V

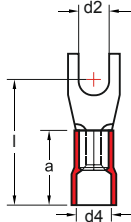

ÜRÜN KODU	RENK	KABLO KESİTİ	METRİK VİDA	ÖLÇÜ				KUTU ADEDİ	₺ / ADET
				d2	l	d4	a		
SK 8064	●	0,5 - 1,5	3	3,2	16,0	4,0	10,0	200	0,200
SK 8065	●	0,5 - 1,5	4	4,3	17,0	4,0	10,0	200	0,210
SK 8066	●	0,5 - 1,5	5	5,3	18,0	4,0	10,0	200	0,230
SK 8067	●	0,5 - 1,5	6	6,5	18,0	4,0	10,0	200	0,250
SK8072	●	1,5 - 2,5	3	3,2	16,0	4,5	10,0	200	0,230
SK8073	●	1,5 - 2,5	4	4,3	17,0	4,5	10,0	200	0,240
SK8074	●	1,5 - 2,5	5	5,3	19,0	4,5	10,0	200	0,250
SK8075	●	1,5 - 2,5	6	6,5	21,0	4,5	10,0	200	0,310
SK8078	●	4,0 - 6,0	4	4,3	21,0	6,3	13,0	100	0,500
SK8079	●	4,0 - 6,0	5	5,3	22,0	6,3	13,0	100	0,510
SK8080	●	4,0 - 6,0	6	6,5	22,5	6,3	13,0	100	0,670
SK8081	●	4,0 - 6,0	8	8,4	26,0	6,3	13,0	100	0,780

İZOLELİ FASTON DİŞİ KABLO UÇLARI (PRİNÇ İLETKEN)



Standart : DIN 46237
Malzeme : Pirinç, Kalay Kaplı
İzolasyon : PVC
Çalışma Sıcaklığı : max.75°C - 300V



ÜRÜN KODU	RENK	KABLO KESİTİ	SOKET GENİŞLİĞİ	ÖLÇÜ					KUTU ADEDİ	₺ / ADET
				W	F	L	B	D		
SK 8232	●	0,5 - 1,5	0,8 x 4,80	5,0	6,4	19,4	10,5	3,8	200	0,310
SK 8234	●	0,5 - 1,5	0,8 x 6,35	6,6	7,5	20,8	10,5	3,8	200	0,400
SK 8235	●	1,5 - 2,5	0,8 x 2,80	5,0	6,4	19,4	10,5	4,7	200	0,310
SK 8239	●	1,5 - 2,5	0,8 x 4,80	5,0	6,4	19,4	10,5	4,7	200	0,400
SK 8240	●	1,5 - 2,5	0,8 x 6,35	6,6	7,5	20,8	10,5	4,7	200	0,410
SK 8243	●	4,0 - 6,0	0,8 x 6,35	6,6	7,5	23,3	13,0	6,2	200	0,480

İZOLELİ FASTON ERKEK KABLO UÇLARI (PRİNÇ İLETKEN)

ÜRÜN KODU	RENK	KABLO KESİTİ	SOKET GENİŞLİĞİ	ÖLÇÜ					KUTU ADEDİ	₺ / ADET
				W	F	L	B	D		
SK 2229	●	0,5 - 1,5	0,8 x 2,80	6,35	7,7	21,8	10,5	3,8	200	0,280
SK 2224	●	0,5 - 1,5	0,8 x 4,80	4,8	6,7	19,8	10,5	3,8	200	0,280
SK 2225	●	0,5 - 1,5	0,8 x 6,35	6,35	7,7	21,8	10,5	3,8	200	0,330
SK 2226	●	1,5 - 2,5	0,8 x 4,80	4,8	6,7	19,8	10,5	4,7	200	0,280
SK 2227	●	1,5 - 2,5	0,8 x 6,35	6,35	7,7	21,8	10,5	4,7	200	0,330
SK 2228	●	4,0 - 6,0	0,8 x 6,35	6,35	7,7	24,0	13,0	6,2	200	0,440



Malzeme : Pirinç, Kalay Kaplı
İzolasyon : Pvc
Çalışma Sıcaklığı : max.75°C - 300V



TAM İZOLELİ FASTON DIŞI KABLO UÇLARI (PRİNÇ İLETKEN)

ÜRÜN KODU	RENK	KABLO KESİTİ	SOKET GENİŞLİĞİ	ÖLÇÜ					KUTU ADEDİ	₺ / ADET
				W	F	L	B	D		
SK 8250	●	0,5 - 1,5	0,8 x 2,80	3,2	6,5	19,0	10,5	3,8	200	0,380
SK 8252	●	0,5 - 1,5	0,8 x 4,80	5,0	6,4	20,5	10,5	3,8	200	0,380
SK 8254	●	0,5 - 1,5	0,8 x 6,35	6,6	7,5	21,8	10,5	4,7	200	0,520
SK 8257	●	1,5 - 2,5	0,8 x 4,80	3,2	6,5	20,0	10,5	4,7	200	0,390
SK 8259	●	1,5 - 2,5	0,8 x 6,35	5,0	6,4	20,2	10,5	4,7	200	0,520
SK 8260	●	4,0 - 6,0	0,8 x 6,35	6,6	7,5	24,2	12,5	6,2	100	0,570



Malzeme : Pirinç, Kalay Kaplı
İzolasyon : Pvc
Çalışma Sıcaklığı : max.75°C - 300V



İĞNE TİP KABLO UÇLARI (PRİNÇ İLETKEN)

ÜRÜN KODU	RENK	KABLO KESİTİ	SOKET GENİŞLİĞİ	ÖLÇÜ					KUTU ADEDİ	₺ / ADET
				W	F	L	B	D		
SK 2135	●	0,5 - 1,5	1,9	10,0	19,0	10,0	4,0	200	200	0,240
SK 2136	●	1,5 - 2,5	1,9	12,0	21,8	10,0	4,5	200	200	0,290
SK 2137	●	4,0 - 6,0	2,8	14,0	27,0	27,0	6,4	200	200	0,670



Malzeme : Pirinç, Kalay Kaplı
İzolasyon : Pvc
Çalışma Sıcaklığı : max.75°C - 300V



EK MUFLAR (BAKIR İLETKEN)

ÜRÜN KODU	RENK	KABLO KESİTİ	ÖLÇÜ			KUTU ADEDİ	₺ / ADET
			L	D	d1		
SK 2138	●	0,5 - 1,5	24,6	4,0	1,7	200	0,310
SK 2139	●	1,5 - 2,5	24,6	4,5	2,3	200	0,340
SK 2140	●	4,0 - 6,0	26,5	6,3	3,4	100	0,550



Standart : DIN 46237
Malzeme : Bakır, Kalay Kaplı
İzolasyon : Pvc
Çalışma Sıcaklığı : max.75°C - 300V



STANDART TERMİNALLER

ÜRÜN KODU	AÇIKLAMA	KOLİ ADEDİ	₺ / ADET
SF-1D	Dişi terminal (6,3)	300	0,190
SF-1/2D	Dişi terminal (2,8)	1000	0,093
SF-1DM	Mini dişi terminal (4,8)	500	0,155
SF-1DE	Dişi-erkek terminal (6,3)	200	0,400
SF-1E ÇK	Erkek terminal (6,3)	300	0,200
SK-2,5-4	Topraklama terminali	1000	0,200
SK-4,0-5	Topraklama terminali	500	0,350
SK-6,0-6	Topraklama terminali	250	0,380
SKN 2,5/4-5-6	Topraklama terminali	500	0,170
SKN 4/4-5-6	Topraklama terminali	250	0,400
SKN 6/6-8	Topraklama terminali	150	0,520
SKN 10/8-10-12-13	Topraklama terminali	100	0,650
SF-1D TK	Terminal kılıfı	300	0,110





KABLO BAĞLARI & ETİKETLERİ

KABLO BAĞLARI

ÜRÜN KODU	AÇIKLAMA	BAĞLAMA ÇAPI	RENK	KUTU ADEDİ	KOLİ ADEDİ	₺ / ADET
SK 8480	2,5 / 100 kablo bağı	18	Beyaz / Siyah	100	26.000	0,050
SK 8481	2,5 / 150 kablo bağı	35	Beyaz / Siyah	100	20.000	0,075
SK 8482	2,5 / 200 kablo bağı	50	Beyaz / Siyah	100	18.000	0,10
SK 8483	3,6 / 140 kablo bağı	35	Beyaz / Siyah	100	12.000	0,12
SK 8484	3,6 / 200 kablo bağı	50	Beyaz / Siyah	100	10.000	0,16
SK 8485	3,6 / 250 kablo bağı	65	Beyaz / Siyah	100	8.000	0,19
SK 8486	3,6 / 280 kablo bağı	76	Beyaz / Siyah	100	8.000	0,24
SK 8487	3,6 / 370 kablo bağı	102	Beyaz / Siyah	100	6.000	0,30
SK 8489	4,8 / 200 kablo bağı	50	Beyaz / Siyah	100	7.000	0,21
SK 8490	4,8 / 250 kablo bağı	60	Beyaz / Siyah	100	6.000	0,28
SK 8491	4,8 / 300 kablo bağı	76	Beyaz / Siyah	100	5.000	0,32
SK 8492	4,8 / 370 kablo bağı	102	Beyaz / Siyah	100	4.000	0,40
SK 8493	4,8 / 430 kablo bağı	110	Beyaz / Siyah	100	3.000	0,51
SK 8495	7,6 / 300 kablo bağı	76	Beyaz / Siyah	100	3.000	0,63
SK 8496	7,6 / 370 kablo bağı	102	Beyaz / Siyah	100	2.500	0,75
SK 8497	7,6 / 450 kablo bağı	110	Beyaz / Siyah	100	2.000	0,90
SK 8498	7,6 / 550 kablo bağı	140	Beyaz / Siyah	100	1.500	1,40
SK 8499	7,6 / 750 kablo bağı	223	Beyaz / Siyah	100	1.200	1,80
SK 8500	9,0 / 600 kablo bağı	185	Beyaz / Siyah	100	1.200	2,00
SK 8501	9,0 / 710 kablo bağı	220	Beyaz / Siyah	100	1.200	2,20
SK 8502	9,0 / 760 kablo bağı	236	Beyaz / Siyah	100	1.200	2,40
SK 8503	9,0 / 900 kablo bağı	270	Beyaz / Siyah	100	1.200	2,98

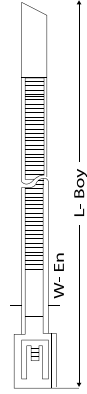

PASLANMAZ ÇELİK KABLO BAĞLARI

ÜRÜN KODU	AÇIKLAMA	BAĞLAMA ÇAPI	RENK	KOLİ ADEDİ	₺ / ADET
SK MTL 150ST	4,6 / 150 kablo bağı	44	Metal	100	1,32
SK MTL 200ST	4,6 / 200 kablo bağı	51		100	1,56
SK MTL 260ST	4,6 / 260 kablo bağı	69		100	1,68
SK MTL 300ST	4,6 / 300 kablo bağı	76		100	1,80
SK MTL 370ST	4,6 / 370 kablo bağı	102		100	1,92
SK MTL 520ST	4,6 / 520 kablo bağı	152		100	2,22
SK MTL 680ST	4,6 / 680 kablo bağı	203		100	3,36
SK MTL 840ST	4,6 / 840 kablo bağı	254		100	3,96
SK MTL 200HD	7,9 / 200 kablo bağı	50	Metal	100	2,28
SK MTL 300HD	7,9 / 300 kablo bağı	75		100	2,52
SK MTL 370HD	7,9 / 370 kablo bağı	102		100	2,65
SK MTL 520HD	7,9 / 520 kablo bağı	152		100	3,48
SK MTL 680HD	7,9 / 680 kablo bağı	203		100	3,96
SK MTL 840HD	7,9 / 840 kablo bağı	224		100	4,92



ETİKETLİ KABLO BAĞLARI

ÜRÜN KODU	AÇIKLAMA	K. ADEDİ	₺ / ADET
GTK 100 MC	100 x 2.5 mm - Beyaz	100	0,15
GTK 190 STC	190 x 4.8 mm - Beyaz	100	0,39



DİSTANSLI KABLO BAĞLARI

ÜRÜN KODU	AÇIKLAMA	K.ADEDİ	₺ / ADET
GTP 100 M	100 x 2.5 mm - Beyaz	100	0,14
GTP 150 I	150 x 3.6 mm - Beyaz	100	0,20
GTP 200 ST	200 x 4.8 mm - Beyaz	100	0,42



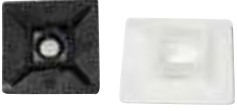

YAPIŞKAN KROŞELER

ÜRÜN KODU	RENK	K. ADEDİ	₺ / ADET
SK 19 x 19	Beyaz / Siyah	100	0,29
SK 28 x 28	Beyaz / Siyah	100	0,52



PASLANMAZ ÇELİK ETİKET

ÜRÜN KODU	AÇIKLAMA	K. ADEDİ	₺ / ADET
MTL PE	19 x 90 mm - Metal	100	1,75



KABLO KELEPÇESİ

ÜRÜN KODU	AÇIKLAMA	K. ADEDİ	₺ / ADET
GCL 1/4	Beyaz	100	0,25
GCL 3/8	Beyaz	100	0,31



KARTUŞ YÜKSELTİCİ

ÜRÜN KODU	AÇIKLAMA	K. ADEDİ	₺ / ADET
CBS-9A	CBS-9A, Beyaz	1000	0,30
CBS-13A	CBS-13A, Beyaz	1000	0,31
CBS-16A	CBS-16A, Beyaz	1000	0,36



BETON KROŞE

ÜRÜN KODU	AÇIKLAMA	K. ADEDİ	₺ / ADET
TH-2	9.5 x 36 mm - Siyah	100	0,39



VİDALI KROŞE

ÜRÜN KODU	AÇIKLAMA	K. ADEDİ	₺ / ADET
VKV-1	14.9 x 9.5 mm - Beyaz	100	0,22
VKV-2	22.2 x 15.9 mm - Beyaz	100	0,31



KABLO BAĞI ETİKET TAŞIYICI

ÜRÜN KODU	AÇIKLAMA	K. ADEDİ	₺ / ADET
GET-1	35 x 10 x 8 mm - Beyaz	100	0,70
GET-2	45 x 20 x 8 mm - Beyaz	100	1,10



YAPIŞKANLI PANO ETİKETİ

ÜRÜN KODU	AÇIKLAMA	K. ADEDİ	₺ / ADET
GPET-1	30 x 17 x 27.5 mm - Siyah	100	0,89
GPET-2	50 x 17 x 49 mm - Siyah	50	1,20
GPET-3	75 x 17 x 72 mm - Siyah	25	1,65



KABLO İŞARETLEME SİSTEMLERİ

ÜRÜN KODU	ÖLÇÜ	MAKARA	₺ / ADET
EC-0	0,50 - 1 mm kablolar için	1000	24,00
EC-1	1,50 - 6 mm kablolar için	1000	24,00
EC-2	4 - 16 mm kablolar için	500	24,00
EC-3	10 - 25 mm kablolar için	350	24,00



PANO AKSESUARLARI & BANTLAR

ISIYLA DARALAN MAKARON

ÜRÜN KODU	ÇAP (mm)	METRE	\$/ ADET
IDM 1	1	200	0,076 \$
IDM 1,5	1,5	200	0,076 \$
IDM 1,6	1,6	200	0,076 \$
IDM 2	2	200	0,087 \$
IDM 2,4	2,4	200	0,087 \$
IDM 2,5	2,5	200	0,11 \$
IDM 3	3	200	0,12 \$
IDM 3,2	3,2	200	0,12 \$
IDM 3,5	3,5	200	0,125 \$
IDM 4	4	200	0,15 \$
IDM 4,5	4,5	100	0,16 \$
IDM 4,8	4,8	100	0,16 \$
IDM 5	5	100	0,185 \$
IDM 6	6	100	0,21 \$
IDM 6,4	6,4	100	0,21 \$
IDM 7	7	100	0,26 \$
IDM 8	8	100	0,26 \$
IDM 9,5	9,5	100	0,27 \$
IDM 10	10	100	0,29 \$
IDM 12,7	12,7	100	0,32 \$
IDM 13	13	100	0,35 \$
IDM 14	14	100	0,44 \$
IDM 16	16	100	0,56 \$
IDM 18	18	100	0,73 \$
IDM 19,1	19,1	100	0,73 \$
IDM 20	20	100	0,91 \$
IDM 22	22	100	1,12 \$
IDM 25,4	25,4	50	1,20 \$
IDM 30	30	50	1,62 \$
IDM 32	32	50	1,62 \$
IDM 35	35	50	2,25 \$
IDM 38	38	50	2,41 \$
IDM 40	40	50	2,43 \$
IDM 51	51	25	3,43 \$
IDM 60	60	25	4,75 \$
IDM 70	70	25	6,12 \$
IDM 80	80	25	7,12 \$
IDM 102	102	25	8,75 \$
IDM 120	120	25	12,50 \$
IDM 150	150	25	20,00 \$
IDM 180	180	25	26,00 \$

*Renkli makaronlar için fiyat sorunuz.

KABLO ÇORABI (HALOGEN FREE)

ÜRÜN KODU	AÇIKLAMA	KOLİ ADEDİ	\$/ ADET
KTC 5	Kablo toplama çorabı	100	0,30 \$
KTC 8	Kablo toplama çorabı	100	0,35 \$
KTC 10	Kablo toplama çorabı	100	0,40 \$
KTC 12	Kablo toplama çorabı	100	0,45 \$
KTC 15	Kablo toplama çorabı	100	0,55 \$
KTC 20	Kablo toplama çorabı	100	0,65 \$
KTC 25	Kablo toplama çorabı	100	0,82 \$
KTC 30	Kablo toplama çorabı	50	098 \$
KTC 40	Kablo toplama çorabı	50	1,28 \$
KTC 50	Kablo toplama çorabı	25	1,65 \$

H CLASS CAM ELYAF SİLİKON İZOLELİ MAKARONLAR

ÜRÜN KODU	ÇAP (mm)	METRE	\$/ ADET
IDM 2H	2	200	0,24 \$
IDM 3H	3	100	0,32 \$
IDM 4H	4	100	0,43 \$
IDM 5H	5	100	0,54 \$
IDM 6H	6	100	0,62 \$
IDM 7H	7	100	0,82 \$
IDM 8H	8	50	0,90 \$
IDM 10H	10	50	1,38 \$
IDM 12H	12	50	1,90 \$
IDM 14H	14	50	2,00 \$
IDM 16H	16	25	2,92 \$
IDM 18H	18	25	3,00 \$
IDM 20H	20	25	3,84 \$
IDM 25H	25	25	7,20 \$
IDM 30H	30	25	10,50 \$
IDM 35H	35	25	13,20 \$



BANTLAR

ÜRÜN KODU	AÇIKLAMALAR	KOLİ ADEDİ	\$/ ADET
ERİYEN BANT - İNCE	Eriyen bant (19 mm)	60	2,95 \$
ERİYEN BANT - KALIN	Eriyen bant (50 mm)	24	7,10 \$
GLOBE BANT	İzole bant	500	Fiyat Sorunuz
GENİŞ BANT	Geniş izole bant	36	Fiyat Sorunuz



HELEZON SPİRALLER

ÜRÜN KODU	ÖLÇÜ (cm)	BAÇ	\$/ ADET
No.1	50	100	0,36
No.2	50	100	0,77
No.3	50	100	1,15
No.4	50	50	2,50
No.5	50	50	2,60

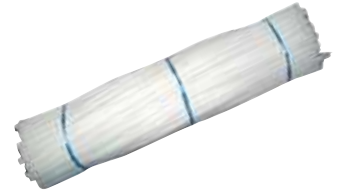

HELEZON SPİRALLER RULO

ÜRÜN KODU	ÖLÇÜ (mt)	İÇ ÇAP	DIŞ ÇAP	\$/ ADET
No.1	100	5	6	0,72
No.2	100	7	8	1,55
No.3	100	10	11	2,23
No.4	50	13	14	4,97
No.5	50	16	17	5,18



SICAK HAVA TABANCASI

ÜRÜN KODU	AÇIKLAMALAR	K. ADEDİ	\$/ ADET
GW2000	Sıcak hava tabancası	1	75,00 \$



PANO İÇİ TERMOSTAT

ÜRÜN KODU	AÇIKLAMALAR	K. ADEDİ	\$/ ADET
ÇTR02K	Isıtma termostatu	1	45,60
ÇTR01M	Soğutma termostatu	1	45,60
ÇTR05MK	Isıtma + soğutma termostatu	1	114,00



RAYA GEÇMELİ PANO PRİZİ



ÜRÜN KODU	AÇIKLAMALAR	K. ADEDİ	₺ / ADET
CP 6801	Raya geçmeli pano prizi - kapaklı	10	38,50

KARE FANLAR



ÜRÜN KODU	ÜRÜN ÖLÇÜLERİ (cm)	KOLİ ADEDİ	\$/ ADET
BRZ 01	120 x 120 x 25 220V AC	1	9,20 \$
BRZ 02	120 x 120 x 38 220V AC	1	9,20 \$
BRZ 04	120 x 120 x 25 12V DC	1	9,80 \$
BRZ 05	120 x 120 x 25 24V DC	1	9,80 \$
BRZ 08	120 x 120 x 38 110V AC	1	10,30 \$
BRZ 14	80 x 80 x 38 220V AC	1	9,20 \$
BRZ 16	80 x 80 x 25 12V DC	1	4,00 \$
BRZ 17	80 x 80 x 25 24V DC	1	4,00 \$
BRZ 21	172 x 150 x 51 220V AC	1	27,60 \$
BRZ 22	172 x 150 x 51 24V DC	1	27,60 \$
BRZ 23	172 x 150 x 51 115V AC	1	27,60 \$

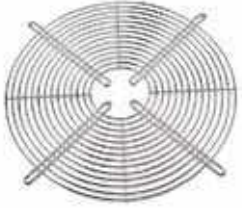

KARE FAN KORUMA TELİ

ÜRÜN KODU	ÜRÜN ÖLÇÜLERİ (cm)	KOLİ ADEDİ	\$/ ADET
TEL 01	80 x 80 fan teli	1	0,75 \$
TEL 03	120 x 120 fan teli	1	0,86 \$
TEL 04	170 x 150 fan teli	1	1,55 \$

SOMUNLU POLYAMİD KABLO RAKORU



ÜRÜN KODU	MONTAJ ÇAPI (mm)	SIKMA ÇAPI (mm)	K. ADEDİ	₺ / ADET
PG 7	13	3-6,5	500	1,20
PG 9	16	4-8	300	1,30
PG 11	19	5-10	200	1,55
PG 13,5	21	6-12	150	1,80
PG 16	23	10-14	125	2,20
PG 21	29	13-18	75	3,20
PG 29	37,5	18-25	40	5,50
PG 36	47,5	22-32	20	10,00
PG 42	54,5	30-38	10	15,50
PG 48	60	34-44	8	18,50

PİRİNÇ KABLO RAKORU (NİKEL KAPLAMA SOMUNLU) IP68



ÜRÜN KODU	MONTAJ ÇAPI (mm)	SIKMA ÇAPI (mm)	K. ADEDİ	₺ / ADET
PG 7/P	13	3-6,5	50	
PG 9/P	16	4-8	50	
PG 11/P	19	5-10	50	
PG 13,5/P	21	6-12	50	
PG 16/P	23	10-14	25	
PG 21/P	29	13-18	25	
PG 29/P	37,5	18-25	20	
PG 36/P	47,5	22-32	15	
PG 42/P	54,5	30-38	12	
PG 48/P	60	34-44	12	

Fiyat Sorunuz



YAYLI BUTONLAR

ÜRÜN KODU	AÇIKLAMA	KONTAK	K. ADEDİ	₺ / ADET
SK EA310	Start Buton 22mm	NO	20	10,50
SK EA420	Stop Buton 22mm	NC	20	10,50
SK ED210	0-1 Kalıcı Mandal Buton 22 mm	NC	20	14,50
SK ED330	1-0-2 Kalıcı Mandal Buton 22 mm	NO+NO	20	17,25
SK EA845	İkiz Buton 22 mm	NO+NC	20	25,50
SK ES542	Acil Stop Butonu 22 mm	NC	20	17,25
SK ED410	0-1 Yaylı Mandal Buton 22 mm	NC	20	15,00
SK ED530	1-0-2 Yaylı Mandal Buton 22 mm	NO+NO	20	17,75
SK ZB101	Start Kontak	NO	20	5,10
SK ZB102	Stop Kontak	NC	20	5,10

ÜRÜN KODU	AÇIKLAMA	KONTAK	K. ADEDİ	₺ / ADET
SK A5-10	Start Buton 22mm	NO	10	16,50
SK A5-01	Stop Buton 22mm	NC	10	16,50
SK A5-10X	0-1 Kalıcı Mandal Buton 22 mm	NC	10	18,50
SK A5-20XS	1-0-2 Kalıcı Mandal Buton 22 mm	NO+NO	10	25,50
SK A5-11R	İkiz Buton 22 mm	NO+NC	10	30,00
SK A1-01ZS	Acil Stop Butonu 22 mm	NC	10	21,50
SK A5-10XFU	0-1 Yaylı Mandal Buton 22 mm	NC	10	21,50
SK A5-20XSFO	1-0-2 Yaylı Mandal Buton 22 mm	NO+NO	10	30,50
SK A-10	Start Kontak	NO	10	8,20
SK A-01	Stop Kontak	NC	10	8,20
BR1	Buton Rozeti 22 mm		10	1,85
ER60	Acil Stop (Emergency) Etiketli 22 mm		10	4,75

İŞIKLI YAYLI BUTONLAR

ÜRÜN KODU	AÇIKLAMA	KONTAK	K. ADEDİ	₺ / ADET
SK A5-10D	Start Buton 22 mm - Yeşil Işıklı	1NO	10	32,75
SK A5-01D	Stop Buton 22 mm - Kırmızı Işıklı	1NC	10	32,75
SK A5-10XD	0-1 Mandal Buton 22 mm - Yeşil Işıklı	1NO	10	34,00
SK A5-01XD	0-1 Mandal Buton 22 mm - Kırmızı Işıklı	1NC	10	34,00
SK A5-20XSD	1-0-2 Mandal Buton 22 mm - Yeşil Işıklı	2NO	10	41,50
SK A5-02XSD	1-0-2 Mandal Buton 22 mm - Kırmızı Işıklı	2NC	10	41,50
SK A5-11RD	Işıklı İkiz Buton 22 mm	1NO+1NC	10	45,50

10 mm PLASTİK KABLOLU SİNYAL LAMBASI

ÜRÜN KODU	RENK	VOLTAJ	AÇIKLAMA	K. ADEDİ	₺ / ADET
AD22E005R	●	220V	Kablolu Sinyal 10 mm	100	5,00
AD22E005G	●	220V	Kablolu Sinyal 10 mm	100	5,00
AD22E005Y	●	220V	Kablolu Sinyal 10 mm	100	5,00

16 mm LEDLİ SİNYAL LAMBASI

ÜRÜN KODU	RENK	VOLTAJ	AÇIKLAMA	K. ADEDİ	₺ / ADET
SK 16-220Y	●	220V AC	Led Işıklı Sinyal Lambası 16 mm	10	9,70
SK 16-220K	●	220V AC	Led Işıklı Sinyal Lambası 16 mm	10	9,70
SK 16-220S	●	220V AC	Led Işıklı Sinyal Lambası 16 mm	10	9,70
SK 16-220B	○	220V AC	Led Işıklı Sinyal Lambası 16 mm	10	10,50
SK 16-220M	●	220V AC	Led Işıklı Sinyal Lambası 16 mm	10	10,50
SK 16-24Y	●	24V AC-DC	Led Işıklı Sinyal Lambası 16 mm	10	9,70
SK 16-24K	●	24V AC-DC	Led Işıklı Sinyal Lambası 16 mm	10	9,70
SK 16-24S	●	24V AC-DC	Led Işıklı Sinyal Lambası 16 mm	10	9,70
SK 16-24B	○	24V AC-DC	Led Işıklı Sinyal Lambası 16 mm	10	10,50
SK 16-24M	●	24V AC-DC	Led Işıklı Sinyal Lambası 16 mm	10	10,50



22 mm LEDLİ SİNYAL LAMBASI

ÜRÜN KODU	RENK	VOLTAJ	AÇIKLAMA	K. ADEDİ	₺ / ADET
SK 22-220Y	●	220V AC	Led Işıklı Sinyal Lambası 22 mm	10	6,00
SK 22-220K	●	220V AC	Led Işıklı Sinyal Lambası 22 mm	10	6,00
SK 22-220S	●	220V AC	Led Işıklı Sinyal Lambası 22 mm	10	6,00
SK 22-220B	○	220V AC	Led Işıklı Sinyal Lambası 22 mm	10	6,75
SK 22-220M	●	220V AC	Led Işıklı Sinyal Lambası 22 mm	10	6,75
SK 22-24Y	●	24V AC-DC	Led Işıklı Sinyal Lambası 22 mm	10	6,00
SK 22-24K	●	24V AC-DC	Led Işıklı Sinyal Lambası 22 mm	10	6,00
SK 22-24S	●	24V AC-DC	Led Işıklı Sinyal Lambası 22 mm	10	6,00
SK 22-24B	○	24V AC-DC	Led Işıklı Sinyal Lambası 22 mm	10	6,75
SK 22-24M	●	24V AC-DC	Led Işıklı Sinyal Lambası 22 mm	10	6,75



22 mm BUZZER 90 dB

ÜRÜN KODU	AÇIKLAMA	K. ADEDİ	₺ / ADET
AD116-0085	Ledli Buzzer AC 220V Kırmızı	10	27,00
AD116-0084	Ledli Buzzer AC - DC 24V Kırmızı	10	27,00



22 mm VOLTMETRE & AMPERMETRE

ÜRÜN KODU	AÇIKLAMA	K. ADEDİ	₺ / ADET
SK 22-VS-K	22 mm Voltmetre 24-450V - Kırmızı	10	24,00
SK 22-VS-Y	22 mm Voltmetre 24-450V - Yeşil	10	24,00
SK 22-VS-S	22 mm Voltmetre 24-450V - Sarı	10	24,00
SK 22-AS-K	22 mm Ampermetre 100A - Kırmızı	10	49,00
SK 22-AS-Y	22 mm Ampermetre 100A - Yeşil	10	49,00
SK 22-AS-S	22 mm Ampermetre 100A - Sarı	10	49,00
SK 22-VAS-K	22 mm Amper+Volt - Kırmızı	10	80,00
SK 22-VAS-Y	22 mm Amper+Volt - Yeşil	10	80,00
SK 22-VAS-S	22 mm Amper+Volt - Sarı	10	80,00



BOŞ KUMANDA KUTULARI

ÜRÜN KODU	AÇIKLAMA	K. ADEDİ	₺ / ADET
SK-BH100	1'li Boş Kutu	1	9,90
SK-BH200	2'li Boş Kutu	1	13,50
SK-BH300	3'lü Boş Kutu	1	15,50
SK-BH400	4'lü Boş Kutu	1	22,00
SK-BH500	5'li Boş Kutu	1	36,50
SK-BH600	6'lı Boş Kutu	1	38,50
LAY2-KSE542	1'li Mantar Acil Stop Butonu	1	28,50





SİVİÇLER, VİNÇ KUMANDA BUTONLARI
& PEDALLAR

DOĞRUSAL HAREKETLİ METAL PİM



KOD	CLS101
KUTU ADEDİ	10
ADET / ₺	46,00

DOĞRUSAL HAREKETLİ METAL MAKARALI PİM



KOD	CLS103
KUTU ADEDİ	10
ADET / ₺	46,00

DOĞRUSAL HAREKETLİ METAL MAKARALI PİM + RESETLİ



KOD	CLS103R
KUTU ADEDİ	10
ADET / ₺	48,75

AÇISAL HAREKETLİ 14 mm METAL MAKARALI PİM



KOD	CLS111
KUTU ADEDİ	10
ADET / ₺	46,00

AÇISAL HAREKETLİ 18 mm MAKARALI DÖNER KOL



KOD	CLS121
KUTU ADEDİ	10
ADET / ₺	46,00

AÇISAL HAREKETLİ 18 mm AYARLANABİLİR MAKARALI DÖNER KOL



KOD	CLS131
KUTU ADEDİ	10
ADET / ₺	48,75

AÇISAL HAREKETLİ SİRAL TELLİ ÇOK YÖNLÜ KOL



KOD	CLS161
KUTU ADEDİ	10
ADET / ₺	46,00

AÇISAL HAREKETLİ 18 mm AYARLANABİLİR MAKARALI



KOD	CLS191
KUTU ADEDİ	10
ADET / ₺	48,75

BUTON TAHRİKLİ METAL



KOD	CSA001
KUTU ADEDİ	10
ADET / ₺	122,50

METAL MAKARA DİKEY



KOD	CSA003
KUTU ADEDİ	10
ADET / ₺	122,50

METAL MAKARA KOL YATAY



KOD	CSA012
KUTU ADEDİ	10
ADET / ₺	122,50

18mm SAĞ - SOL METAL MAKARA



KOD	CSA021
KUTU ADEDİ	10
ADET / ₺	122,50

18mm AYARLI SAĞ - SOL METAL MAKARA



KOD	CSA031
KUTU ADEDİ	10
ADET / ₺	122,50

SİRAL TELLİ METAL



KOD	CSA061
KUTU ADEDİ	10
ADET / ₺	122,50

AÇIK KONTAK PANO KAPI SWITCH



KOD	AKS10
KUTU ADEDİ	10
ADET / ₺	13,50

KAPALI KONTAK PANO KAPI SWITCH



KOD	AKS01
KUTU ADEDİ	10
ADET / ₺	13,50



MİKRO SIVIÇLER

ÜRÜN KODU	AÇIKLAMA	K. ADEDİ	₺ / ADET
6811	İnce Kısa Pimli 15A 1NO + 1NC	20	25,00
6812	Kalın Uzun Pimli 15A 1NO + 1NC	20	25,00
6813	İnce Uzun Pimli 15A 1NO + 1NC	20	28,75
6814	Uzun Palet 15A 1NO + 1NC	20	25,00
6815	Uzun Palet Metal Makaralı 15A 1NO + 1NC	20	28,75
6817	Kısa Paletli 15A 1NO + 1NC	20	25,00
6818	Kısa Metal Makaralı 15A 1NO + 1NC	20	28,75
6819	Tahrikli Metal Makaralı 15A 1NO + 1NC	20	28,75
6820	Dikey Metal Makaralı 15A 1NO + 1NC	20	37,50
6821	Kalın Kısa Metal Pimli 15A 1NO + 1NC	20	35,50
6822	Yan Dik Metal Makaralı 15A 1NO + 1NC	20	37,50
6823	Uzun Tel Palet 15A 1NO + 1NC	20	28,75
6824	Koruma Kabı	20	6,00



GMS SERİSİ MİKRO SIVIÇLER

ÜRÜN KODU	AÇIKLAMA	K. ADEDİ	₺ / ADET
6830	10 Amper Plastik Pimli Mikro Switch	100	9,50
6831	10 Amper Orta Kollu Mikro Switch	100	9,50
6832	10 Amper Kısa Kollu Mikro Switch	100	9,50
6833	10 Amper Uzun Kollu Metal Makaralı Mikro Switch	100	9,50
6834	10 Amper Kısa Kollu Metal Makaralı Mikro Switch	100	9,50
6835	10 Amper Uzun Kollu Mikro Switch	100	9,50
6836	10 Amper Kıvrık Kollu Mikro Switch	100	9,50

VİNÇ KUMANDA BUTONLARI

ÜRÜN KODU	AÇIKLAMA	K. ADEDİ	₺ / ADET
COB-61	2'li Tek hızlı vinç kumanda butonu	1	40,00
COB-62	4'lü Tek hızlı vinç kumanda butonu	1	50,00
COB-63	6'lı Tek hızlı vinç kumanda butonu	1	65,00
COB-64	8'li Tek hızlı vinç kumanda butonu	1	85,00

ACİL STOPLU VİNÇ KUMANDA BUTONLARI

ÜRÜN KODU	AÇIKLAMA	K. ADEDİ	₺ / ADET
COB-C1	2'li Tek hızlı + acil stoplu vinç kumanda butonu	1	160,00
COB-C2	4'lü Tek hızlı + acil stoplu vinç kumanda butonu	1	220,00
COB-C3	6'lı Tek hızlı + acil stoplu vinç kumanda butonu	1	290,00

AYAK PEDALLARI

ÜRÜN KODU	AÇIKLAMA	K. ADEDİ	₺ / ADET
CFS-01	Plastik ayak pedalı	1	43,00
CFS1	Metal ayak pedalı	1	44,00
CFS-2	Metal ayak pedalı	1	62,00
CFS302	Metal ayak pedalı	1	165,00
CFS502	Metal ayak pedalı	1	240,00

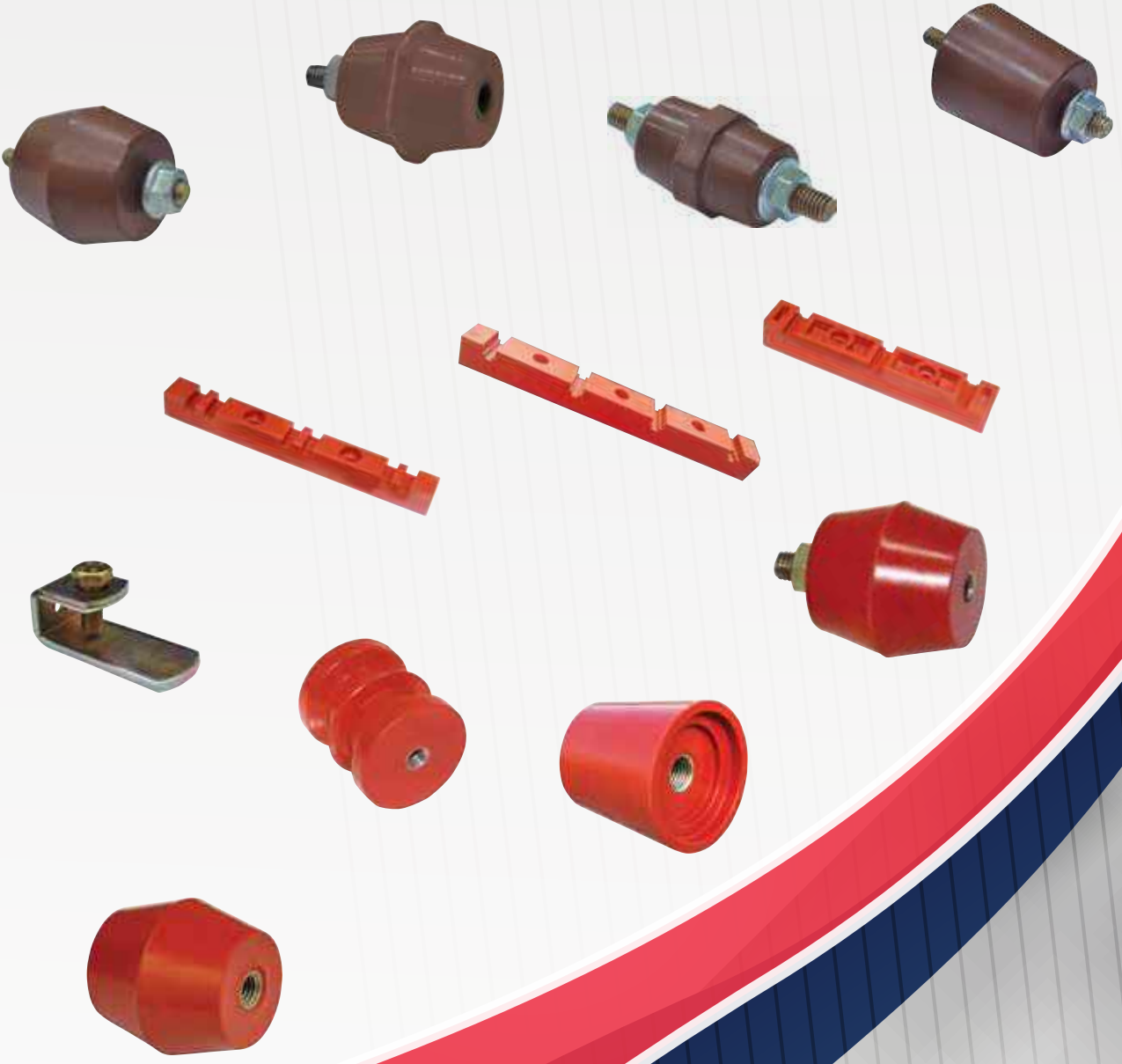

MESNET İZOLATÖRLERİ

M5 SAPLAMALI İZOLATÖR



KOD	BMI-M5/2C
KUTU ADEDİ	250
KOLİ ADEDİ	1500
ADET / ₺	2,80

M6 SAPLAMALI İZOLATÖR (KONİK + FIÇI)



KOD	BMI-M6/2C
KUTU ADEDİ	100
KOLİ ADEDİ	600
ADET / ₺	4,00

M8 SAPLAMALI İZOLATÖR



KOD	BMI-M8/2C
KUTU ADEDİ	100
KOLİ ADEDİ	600
ADET / ₺	6,00

M10 SAPLAMALI İZOLATÖR



KOD	BMI-M10/2C
KUTU ADEDİ	40
KOLİ ADEDİ	240
ADET / ₺	10,50

M5 SAPLAMA + KÖR SOMUN



KOD	BMI-M5/1C+1S
KUTU ADEDİ	250
KOLİ ADEDİ	1500
ADET / ₺	2,75

M6 SAPLAMA + KÖR SOMUN



KOD	BMI-M6/1C+1S
KUTU ADEDİ	150
KOLİ ADEDİ	900
ADET / ₺	4,50

M8 SAPLAMA + KÖR SOMUN



KOD	BMI-M8/1C+1S
KUTU ADEDİ	100
KOLİ ADEDİ	600
ADET / ₺	6,50

M10 SAPLAMA + KÖR SOMUN



KOD	BMI-M10/1C+1S
KUTU ADEDİ	40
KOLİ ADEDİ	240
ADET / ₺	10,80

M8 KÖR SOMUN



KOD	BMI-M8/2S
KUTU ADEDİ	100
KOLİ ADEDİ	600
ADET / ₺	6,25

M10 KÖR SOMUN



KOD	BMI-M10/2S
KUTU ADEDİ	40
KOLİ ADEDİ	240
ADET / ₺	11,00

M16 KÖR SOMUN



KOD	BMI-M16/C
KUTU ADEDİ	12
KOLİ ADEDİ	72
ADET / ₺	32,00

1N 500 İZOLATÖR (M8 / M10)



KOD	1N500
KUTU ADEDİ	20
KOLİ ADEDİ	120
M8 ADET / ₺	16,85
M10 ADET / ₺	18,85

3 x 1F TARAK İZOLATÖR



KOD	3x1F
KUTU ADEDİ	20
KOLİ ADEDİ	120
ADET / ₺	11,50

3 x 2 F TARAK İZOLATÖR



KOD	3x2F
KUTU ADEDİ	40
KOLİ ADEDİ	80
ADET / ₺	15,90

3 x 1 F + N TARAK İZOLATÖR



KOD	3x1F+N
KUTU ADEDİ	40
KOLİ ADEDİ	80
ADET / ₺	16,50

SERFİL M8



KOD	M8
KUTU ADEDİ	100
KOLİ ADEDİ	500
ADET / ₺	8,00



EL ALETLERİ

0,25 - 6 mm² YÜKSÜK SIKMA PENSESİ

KOD	YYTB-4
KUTU ADEDİ	1
ADET / \$	71,00 \$

0,14 - 2,50 mm² YÜKSÜK SIKMA PENSESİ

KOD	YAC-5A
KUTU ADEDİ	1
ADET / \$	73,50 \$

İZOLELİ KABLO UCU VE YÜKSÜK SIKMA PENSESİ

KOD	YAC-11
KUTU ADEDİ	1
ADET / \$	83,00 \$

0,50 - 2,50 mm² YÜKSÜK SIKMA PENSESİ

KOD	YYT-22
KUTU ADEDİ	1
ADET / \$	40,00 \$

0,50 - 6 mm² KABLO SİYIRMA PENSESİ

KOD	YY-78-318
KUTU ADEDİ	1
ADET / \$	33,00 \$

0,25 - 35 mm² YÜKSÜK SIKMA PENSESİ

KOD	YAC-17
KUTU ADEDİ	1
ADET / \$	81,50 \$

1,0 - 10 mm² İZOLELİ TERMİNAL SIKMA PENSESİ

KOD	YYT-12
KUTU ADEDİ	1
ADET / \$	75,00 \$

0,50 - 6 mm² İZOLELİ KABLO UCU SIKMA PENSESİ

KOD	YYT-7
KUTU ADEDİ	1
ADET / \$	75,00 \$

4P/6P/8P KONNEKTÖR SIKMA PENSESİ

KOD	ASA-486
KUTU ADEDİ	1
ADET / \$	110,00 \$

6 - 50 mm² SKP SIKMA PENSESİ

KOD	JY-0650
KUTU ADEDİ	1
ADET / \$	91,50 \$

10 - 120 mm² SKP SIKMA PENSESİ

KOD	JY-06120
KUTU ADEDİ	1
ADET / \$	180,00 \$

25 - 150 mm² SKP SIKMA PENSESİ

KOD	JY-25150
KUTU ADEDİ	1
ADET / \$	187,00 \$

16 - 120 mm² HİDROLİK SKP SIKMA PENSESİ (ÇANTALI SET)

KOD	YYQ 120
KUTU ADEDİ	1
ADET / \$	190,00 \$

16 - 300 mm² HİDROLİK SKP SIKMA PENSESİ (ÇANTALI SET)

KOD	YQK 300
KUTU ADEDİ	1
ADET / \$	200,00 \$



OTOMATİK BASINÇ KONTROL SİSTEMLERİ & FLATÖRLER

MONOFAZE BASINÇ ŞALTERİ



ÜRÜN KODU	AÇIKLAMALAR	KOLİ ADEDİ	₺ / ADET
ELT-5	1 - 6 bar tahliyesiz, (1/4" - 1/2")	1	83,50
ELT-5C	1 - 6 bar tahliyeli, (1/4" - 1/2")	1	88,00
ELT-5CO	1 - 6 bar tahliyeli ON/OFF, (1/4" - 1/2")	1	91,50
ELT-5C-3Y	1 - 6 bar tahliyeli, 3 yollu, (1/4" - 1/2")	1	94,50
ELT-5CO-3Y	1 - 6 bar tahliyeli, 3 yollu, ON-OFF, (1/4" - 1/2")	1	98,00
ELT-6	2 - 11 bar tahliyesiz, (1/4" - 1/2")	1	88,00
ELT-6C	2 - 11 bar tahliyeli, (1/4" - 1/2")	1	91,50
ELT-6CO	2 - 11 bar tahliyeli, ON/OFF, (1/4" - 1/2")	1	94,50
ELT-6C-3Y	2 - 11 bar tahliyeli, 3 yollu, (1/4" - 1/2")	1	98,00
ELT-6CO-3Y	2 - 11 bar tahliyeli 3 yollu, ON-OFF, (1/4" - 1/2")	1	100,00

Siparişte alt bağlantı 1/4 veya 1/2 olarak belirtiniz.

TRİFAZE BASINÇ ŞALTERİ



ÜRÜN KODU	AÇIKLAMALAR	KOLİ ADEDİ	₺ / ADET
ELT-2	2 - 8 bar tahliyesiz, (1/4" - 1/2")	1	100,00
ELT-2C	2 - 8 bar tahliyeli, (1/4" - 1/2")	1	110,00
ELT-2CO	2 - 8 bar tahliyeli ON/OFF, (1/4" - 1/2")	1	112,00
ELT-2C-3Y	2 - 8 bar tahliyeli, 3 yollu, (1/4" - 1/2")	1	119,00
ELT-2CO-3Y	2 - 8 bar tahliyeli, 3 yollu, ON-OFF, (1/4" - 1/2")	1	121,00
ELT-3	3 - 11 bar tahliyesiz, (1/4" - 1/2")	1	100,00
ELT-3C	3 - 11 bar tahliyeli, (1/4" - 1/2")	1	110,00
ELT-3CO	3 - 11 bar tahliyeli, ON/OFF, (1/4" - 1/2")	1	112,00
ELT-3C-3Y	3 - 11 bar tahliyeli, 3 yollu, (1/4" - 1/2")	1	119,00
ELT-3CO-3Y	3 - 11 bar tahliyeli 3 yollu, ON-OFF, (1/4" - 1/2")	1	121,00
ELT-4	4 - 16 bar tahliyesiz, (1/4" - 1/2")	1	100,00
ELT-4C	4 - 16 bar tahliyeli, (1/4" - 1/2")	1	110,00
ELT-4CO	4 - 16 bar tahliyeli, ON/OFF, (1/4" - 1/2")	1	112,00
ELT-4C-3Y	4 - 16 bar tahliyeli, 3 yollu, (1/4" - 1/2")	1	119,00
ELT-4CO-3Y	4 - 16 bar tahliyeli, 3 yollu, ON/OFF (1/4" - 1/2")	1	121,00

Siparişte alt bağlantı 1/4 veya 1/2 olarak belirtiniz.

PRESOSTATLAR



ÜRÜN KODU	AÇIKLAMALAR	KOLİ ADEDİ	₺ / ADET
ELT-35	0,2 - 8 bar (1/4" - 7/16")	1	209,00
ELT-36	5 - 16 bar (1/4" - 7/16")	1	209,00

KUYU TİPİ SEVİYE ELEKTROTU



ÜRÜN KODU	AÇIKLAMALAR	KOLİ ADEDİ	₺ / ADET
ELT-E	Kuyu tipi elektrot	25	25,00

TTR KABLOLU SEVİYE FLATÖRÜ

ÜRÜN KODU	AÇIKLAMALAR	KUTU AD.	KOLİ AD.	₺ / ADET
FT-160	1,60 mt. TTR Seviye Flatörü	1	30	68,00
FT-300	3 mt. TTR Seviye Flatörü	1	30	76,00
FT-500	5 mt. TTR Seviye Flatörü	1	30	97,00
FT-1000	10 mt. TTR Seviye Flatörü	1	15	164,00
FT-1500	15 mt. TTR Seviye Flatörü	1	15	229,00

**KAUÇUK KABLOLU SEVİYE FLATÖRÜ**

ÜRÜN KODU	AÇIKLAMALAR	KUTU AD.	KOLİ AD.	₺ / ADET
FT-160K	1,60 mt. Kauçuk Seviye Flatörü	1	30	84,50
FT-300K	3 mt. Kauçuk Seviye Flatörü	1	30	95,50
FT-500K	5 mt. Kauçuk Seviye Flatörü	1	30	136,00
FT-1000K	10 mt. Kauçuk Seviye Flatörü	1	15	255,00
FT-1500K	15 mt. Kauçuk Seviye Flatörü	1	15	368,00

**90° AÇILI ÇALIŞAN ATIK SIVI SEVİYE FLATÖRÜ**

ÜRÜN KODU	AÇIKLAMALAR	KUTU AD.	KOLİ AD.	₺ / ADET
FT-300A	3 mt. Kauçuk Atık Sıvı Seviye Flatörü	1	25	191,00
FT-500A	5 mt. Kauçuk Atık Sıvı Seviye Flatörü	1	20	212,00
FT-1000A	10 mt. Kauçuk Atık Sıvı Seviye Flatörü	1	15	293,00
FT-1500A	15 mt. Kauçuk Atık Sıvı Seviye Flatörü	1	15	383,00
FT-2000A	20 mt. Kauçuk Atık Sıvı Seviye Flatörü	1	10	434,00

**40° AÇILI ÇALIŞAN ATIK SIVI SEVİYE FLATÖRÜ**

ÜRÜN KODU	AÇIKLAMALAR	KUTU AD.	KOLİ AD.	₺ / ADET
FT-300B	3 mt. Kauçuk Atık Sıvı Seviye Flatörü	1	25	218,00
FT-500B	5 mt. Kauçuk Atık Sıvı Seviye Flatörü	1	20	242,00
FT-1000B	10 mt. Kauçuk Atık Sıvı Seviye Flatörü	1	15	341,00
FT-1500B	15 mt. Kauçuk Atık Sıvı Seviye Flatörü	1	15	419,00
FT-2000B	20 mt. Kauçuk Atık Sıvı Seviye Flatörü	1	10	657,00

**DALGIÇ POMPA KAUÇUK SEVİYE FLATÖRÜ**

ÜRÜN KODU	AÇIKLAMALAR	KUTU AD.	KOLİ AD.	₺ / ADET
FT-60K1	0,60 mt. Kauçuk 2x1 mm 7,8 mm H05-RNF	1	25	56,00
FT-60K2	0,60 mt. Kauçuk 2x1 mm 9,0 mm H07-RNF	1	20	56,00





KAUÇUK FİŞ - PRİZ & AKSESUARLARI

1 x 16 KAUÇUK MONOFAZE ERKEK FİŞ



KOD	SK 2101
KUTU ADEDİ	50
KOLİ ADEDİ	300
ADET / ₺	6,60

1 x 16 KAUÇUK KULPLU FİŞ



KOD	SK 2109
KUTU ADEDİ	40
KOLİ ADEDİ	480
ADET / ₺	7,00

1 x 16 KAUÇUK MONOFAZE DIŞI FİŞ



KOD	SK 2103
KUTU ADEDİ	30
KOLİ ADEDİ	240
ADET / ₺	7,25

1 x 16 MONOFAZE TOPRAKLI DUVAR PRİZ



KOD	SK 2104
KUTU ADEDİ	18
KOLİ ADEDİ	108
ADET / ₺	14,50

1 x 16 KAUÇUK MONOFAZE 2'Lİ GRUP PRİZ



KOD	SK 2105
KUTU ADEDİ	8
KOLİ ADEDİ	96
ADET / ₺	23,00

1 x 16 KAUÇUK MONOFAZE 3'LÜ GRUP PRİZ



KOD	SK 2106
KUTU ADEDİ	6
KOLİ ADEDİ	72
ADET / ₺	24,50

1 x 16 KAUÇUK MONOFAZE 4'LÜ GRUP PRİZ



KOD	SK 2107
KUTU ADEDİ	5
KOLİ ADEDİ	50
ADET / ₺	28,00

3 x 25 KAUÇUK TRİFAZE ERKEK FİŞ



KOD	SK 2201
KUTU ADEDİ	30
KOLİ ADEDİ	180
ADET / ₺	16,00

3 x 25 KAUÇUK TRİFAZE DIŞI FİŞ



KOD	SK 2204
KUTU ADEDİ	20
KOLİ ADEDİ	120
ADET / ₺	19,50

3 x 25 KAUÇUK TRİFAZE DUVAR PRİZ



KOD	SK 2205
KUTU ADEDİ	18
KOLİ ADEDİ	108
ADET / ₺	28,00

3 x 25 KAUÇUK TRİFAZE 2'Lİ GRUP PRİZ



KOD	SK 2210
KUTU ADEDİ	8
KOLİ ADEDİ	48
ADET / ₺	65,00

3 x 25 3'LÜ TRİFAZE GRUP PRİZ



KOD	SK 2213
KUTU ADEDİ	6
KOLİ ADEDİ	36
ADET / ₺	70,00

1 MONOFAZE + 1 TRİFAZE 2'Lİ KAUÇUK PRİZ



KOD	SK 2209
KUTU ADEDİ	8
KOLİ ADEDİ	48
ADET / ₺	65,00

1 MONOFAZE + 2 TRİFAZE 3'LÜ KAUÇUK PRİZ



KOD	SK 2212
KUTU ADEDİ	6
KOLİ ADEDİ	36
ADET / ₺	68,00

TOPRAKLI ERKEK FİŞ



KOD	SK 1201
KUTU ADEDİ	50
KOLİ ADEDİ	600
ADET / ₺	5,50

MİMOZA ERKEK FİŞ



KOD	SK 1203
KUTU ADEDİ	50
KOLİ ADEDİ	950
ADET / ₺	4,00

TOPRAKLI L FİŞ



KOD	SK 1205
KUTU ADEDİ	50
KOLİ ADEDİ	1000
ADET / ₺	5,80

3'LÜ GOLYAT FİŞ



KOD	SK 1208
KUTU ADEDİ	50
KOLİ ADEDİ	500
ADET / ₺	17,00

ANAHTARLI ERKEK FİŞ (IŞIKLI)



KOD	SK 2307
KUTU ADEDİ	50
KOLİ ADEDİ	300
ADET / ₺	17,50

İNGİLİZ ADAPTÖRÜ



KOD	SK 2308
KUTU ADEDİ	50
KOLİ ADEDİ	600
ADET / ₺	5,50

2 MONOFAZE + 1 TRİFAZE 3'LÜ KAUÇUK PRİZ



KOD	SK 2211
KUTU ADEDİ	6
KOLİ ADEDİ	36
ADET / ₺	66,00

TOPRAKLI DİŞİ FİŞ



KOD	SK 1202
KUTU ADEDİ	50
KOLİ ADEDİ	600
ADET / ₺	6,00

MİMOZA DİŞİ FİŞ



KOD	SK 1204
KUTU ADEDİ	50
KOLİ ADEDİ	100
ADET / ₺	4,00

ARAPUAR



KOD	1207
KUTU ADEDİ	50
KOLİ ADEDİ	1000
ADET / ₺	4,25

DUY FİŞ



KOD	SK 1209
KUTU ADEDİ	50
KOLİ ADEDİ	500
ADET / ₺	4,50

YAĞMUR DUY



KOD	SK 2305
KUTU ADEDİ	50
KOLİ ADEDİ	300
ADET / ₺	5,50

TİJ TAKIMI



KOD	SK 2304
KUTU ADEDİ	50
KOLİ ADEDİ	300
ADET / ₺	5,50

BUAT KAPAĞI



KOD	SK 2306
KUTU ADEDİ	100
KOLİ ADEDİ	2000
ADET / ₺	0,80



REÇİNELİ & ISI BÜZÜŞMELİ
KABLO EK MUFLARI

06 - 1 KV KABLO İÇİN REÇİNELİ EK MUF



ÜRÜN KODU	AÇIKLAMALAR	KOLİ ADEDİ	₺ / ADET
TAME-E1 415-425	4 x 1,5 - 4 x 2,5	1	
TAME-E1 404-406	4 x 4 - 4 x 6	1	
TAME-E1 410	4 x 10	1	
TAME-E1 1416	4 x 16	1	
TAME-E1 31610	3 x 16 + 10	1	
TAME-E1 32516	3 x 25 + 16	1	
TAME-E1 33516	3 x 35 + 16	1	
TAME-E1 35025	3 x 50 + 25	1	
TAME-E1 37035	3 x 70 + 35	1	
TAME-E1 39550	3 x 95 + 50	1	
TAME-E1 31207	3 x 120 + 70	1	
TAME-E1 31507	3 x 150 + 70	1	
TAME-E1 38559	3 x 185 + 95	1	
TAME-E1 32401	3 x 240 + 120	1	

Fiyat Sorunuz

06 - 1 KV BAKIR İLETKENLER İÇİN ISI BÜZÜŞMELİ KABLO EK MUFLARI



ÜRÜN KODU	AÇIKLAMALAR	KOLİ ADEDİ	₺ / ADET
TAME-S1 4105	4 x 1,5	1	
TAME-S1 4205	4 x 2,5	1	
TAME-S1 404	4 x 4	1	
TAME-S1 406	4 x 6	1	
TAME-S1 410	4 x 10	1	
TAME-S1 416	4 x 16	1	
TAME-S1 425	4 x 25	1	
TAME-S1 31610	3 x 16 + 10	1	
TAME-S1 32516	3 x 25 + 16	1	
TAME-S1 33516	3 x 35 + 10	1	
TAME-S1 35025	3 x 50 + 25	1	
TAME-S1 37035	3 x 70 + 35	1	
TAME-S1 39550	3 x 95 + 50	1	
TAME-S1 31207	3 x 120 + 70	1	

Fiyat Sorunuz

06 - 1 KV FERMUARLI ISI BÜZÜŞMELİ KABLO EK MUFLARI



ÜRÜN KODU	AÇIKLAMALAR	KOLİ ADEDİ	₺ / ADET
FS1-4105	4 x 1,5	1	
FS1-4205	4 x 2,5	1	
FS1-404	4 x 4	1	
FS1-406	4 x 6	1	
FS1-410	4 x 10	1	
FS1-416	4 x 16	1	
FS1-425	4 x 25	1	
FS1-31610	3 x 16 + 10	1	
FS1-32516	3 x 25 + 16	1	
FS1-33516	3 x 35 + 10	1	
FS1-35025	3 x 50 + 25	1	
FS1-37025	3 x 70 + 35	1	
FS1-39550	3 x 95 + 50	1	
FS1-31207	3 x 120 + 70	1	

Fiyat Sorunuz

*Geçerli TAMER listesinden iskonto sorunuz.

06 - 1 kV PAPUÇSUZ REÇİNELİ KABLO BAŞLIKLARI



ÜRÜN KODU	AÇIKLAMALAR	KOLİ ADEDİ	₺ / ADET
PKB-01	2x1,5 - 3x50+25	50	Fiyat Sorunuz Ⓢ
PKB-02	3x70 - 3x95+50	50	
PKB-03	3x120+70 - 3x150+70	50	



PLASTİK HUNİ KALIPLARI

ÜRÜN KODU	AÇIKLAMALAR	KOLİ ADEDİ	₺ / ADET
EMH 4205	4 x 2,5	1	Fiyat Sorunuz Ⓢ
EMH 63	4 x 10 - 4 x 16	1	
EMH 64	3 x 25 + 16 - 3 x 50 + 25	1	
EMH 70-95	70 - 95	1	
EMH 120-150	120 - 150	1	
EMH 185-240	185 - 240	1	



ISI BÜZÜŞMELİ REÇİNELİ YALITIM BORULARI

ÜRÜN KODU	AÇIKLAMALAR	METRE	₺ / ADET
TIB 9/3	9/3	1,2	Fiyat Sorunuz Ⓢ
TIB 12/4	12/4	1,2	
TIB 16/5	16/5	1,2	
TIB 22/6	22/6	1,2	
TIB 25/8	25/8	1,2	
TIB 33/10	33/10	1,15	



A.G. BUŞIŒ KAPAMA 0,6 - 1 kV

ÜRÜN KODU	UYGUN TRAF0	AKIM AMPER	K.ADET	₺ / ADET
TBK-01	1 kV-1000/1600kVA	2000 - 3150A	1	Fiyat Sorunuz Ⓢ
TBK-05	1 kV-500/800kVA	1000 - 1250A	1	
TBK-04	1 kV-200/400kVA	2000 - 3150A	1	



O.G. BUŞIŒ KAPAMA 6 - 36 kV

ÜRÜN KODU	UYGUN TRAF0	AKIM AMPER	K.ADET	₺ / ADET
TBK-02	36 kV-10/1600kVA	250 - 3150A	1	Fiyat Sorunuz Ⓢ



O.G. VHD İZOLATOR KAPAMA 6 - 36 kV

ÜRÜN KODU	UYGUN TRAF0	K.ADET	₺ / ADET
TBK-03 BORULU	36 kV, VHD-35 SII	1	Fiyat Sorunuz Ⓢ
TBK-03 BORUSUZ	36 kV, VHD-35 SII	1	



PROTOLİNLER

ÜRÜN KODU	AÇIKLAMALAR	KOLİ ADEDİ	₺ / ADET
TAME-PRO 210	210 gr protolin	50	Fiyat Sorunuz Ⓢ
TAME-PRO 300	300 gr protolin	50	
TAME-PRO 500	500 gr protolin	45	
TAME-PRO 1000	1000 gr protolin	24	
TAME-PRO 1500	1500 gr protolin	16	
TAME-PRO 3000	3000 gr protolin	6	
TAME-PRO 4000	4000 gr protolin	6	



*Geçerli TAMER Listesinden iskonto sorunuz.



MOTORLU SİREN & İKAZ LAMBALARI

MOTORLU SİRENLER

ÜRÜN KODU	AÇIKLAMALAR	KOLİ ADEDİ	₺ / ADET
MS190	75 mm, 105dB, Metal gövde siren 220V AC	40	
0012	150 W, 50Hz, 115dB, Metal gövde siren 220V AC	1	
0016	200W, 50Hz, 125dB, Metal gövde siren 220V AC	1	
0020	150W, 50Hz, 110dB, Plastik gövde siren 220V AC	1	
0024	200W, 50Hz, 115dB, Plastik gövde siren 220V AC	1	
0048	300W, 50Hz, 150dB, Döküm gövde siren 220V AC	1	
0056	800W, 50Hz, 180dB, Döküm gövde siren 220V AC	1	

Fiyat Sorunuz



XENON UÇAK İKAZ LAMBALARI

ÜRÜN KODU	AÇIKLAMALAR	KOLİ ADEDİ	₺ / ADET
0283	ABS Gövde, 220V AC, Xenon Çakar	1	
0281	ABS Gövde, 24V DC, Xenon Çakar	1	
0280	ABS Gövde, 12V DC, Xenon Çakar	1	

Fiyat Sorunuz



LEDLİ UÇAK İKAZ LAMBALARI

ÜRÜN KODU	AÇIKLAMALAR	KOLİ ADEDİ	₺ / ADET
0287	ABS Gövde, 220V AC, Ledli Flaşörlü	1	
0286	ABS Gövde, 110V AC, Ledli Flaşörlü	1	
0285	ABS Gövde, 24V DC, Ledli Flaşörlü	1	
0284	ABS Gövde, 12V DC, Ledli Flaşörlü	1	

Fiyat Sorunuz



ÇAKMAKLI VE MIKNATISLI DÖNER İKAZ LAMBALARI

ÜRÜN KODU	AÇIKLAMALAR	KOLİ ADEDİ	₺ / ADET
0316	ABS Gövde, 12-24V DC, Döner lamba	1	
0317	ABS Gövde, 12-24V DC, Ledli, döner ve çakar lamba	1	

Fiyat Sorunuz



LEDLİ BORULU KORNA

ÜRÜN KODU	AÇIKLAMALAR	KOLİ ADEDİ	₺ / ADET
0156	220V AC, 105dB, Flaşör ledli	1	
0155	110V AC, 105dB, Flaşör ledli	1	
0154	24V DC, 105dB, Flaşör ledli	1	
0153	12V DC, 105dB, Flaşör ledli	1	
0160	220V AC, 115dB, Sabit flaşör, döner ve çakar ayarlanabilir	1	
0159	110V AC, 115dB, Sabit flaşör, döner ve çakar ayarlanabilir	1	
0158	24V DC, 115dB, Sabit flaşör, döner ve çakar ayarlanabilir	1	
0157	12V DC, 115dB, Sabit flaşör, döner ve çakar ayarlanabilir	1	

Fiyat Sorunuz



ACİL AYDINLATMA ARMATÜRLERİ

ÜRÜN KODU	AÇIKLAMALAR	KOLİ ADEDİ	₺ / ADET
0442	Elektrik kesintisinde 1 saat, ledli, 1x35	1	
0443	Elektrik kesintisinde 3 saat, ledli, 1x35	1	
0448	Elektrik kesintisinde 1 saat, ledli, 2x35	1	
0449	Elektrik kesintisinde 2 saat, ledli, 2x35	1	
0452	Elektrik kesintisinde 1 saat, ledli, 2x50	1	
0453	Elektrik kesintisinde 3 saat, ledli, 2x50	1	

Fiyat Sorunuz



AKTİF PARATONERLER

ÜRÜN KODU	AÇIKLAMALAR	KOR. SEVİYESİ	KOLİ ADEDİ	₺ / ADET
SK 10101	Piramit 250 aktif paratoner	Δ_t 81	1	Fiyat Sorunuz 📞
SK 10112	Nova S aktif paratoner	Δ_t 63	1	
SK 10132	Ufo S aktif paratoner	Δ_t 71	1	

MONTAJ ELEMANLARI

ÜRÜN KODU	AÇIKLAMALAR	KOLİ ADEDİ	₺ / ADET
SK 10201	Direk tespit kelepçesi (köşebent)	1	Fiyat Sorunuz 📞
SK 10343	Direk indirme kroşe (2x50)	1	
SK 10303	Vidalı duvar kroşe (bakır)	1	
SK 12005	Test klemensi	1	
SK 10401	İletken ek klemensi	1	
SK 10383	Plon kroşe (2x50)	1	
SK 10503	Kiremit mahye kroşe (2x50)	1	
SK 11502	Elektrot başlığı (30x1,5)	1	
SK 11512	Elektrot başlığı (20x1)	1	
SK 10213	Paratoner direk sehbası	1	
SK 10207	Direk tespit kelepçesi	1	
SK 10363	Duvar indirme kroşesi - Z tipi (2x50)	1	
SK 10203	Direk tespit kelepçesi (tijli)	1	
SK 18000	Yıldırım sayıcı	1	
SK 18003	Paratoner test cihazı	1	
ALM	Tehlike levhası	1	
SK 158 EKO	Kontrol Kalemi	50	
SK 159	Topaç Kontrol Kalemi	50	



PARAFUDRLAR

ÜRÜN KODU	AÇIKLAMALAR	KOLİ ADEDİ	₺ / ADET
36/10	36/10 polimer gövde parafudr	3	Fiyat Sorunuz 📞
36/5	36/5 polimer gövde parafudr	3	
15/5	15/5 polimer gövde parafudr	3	
PA	Parafudr ayırıcı	3	



Onka®

Profesyonellerin Tercihi

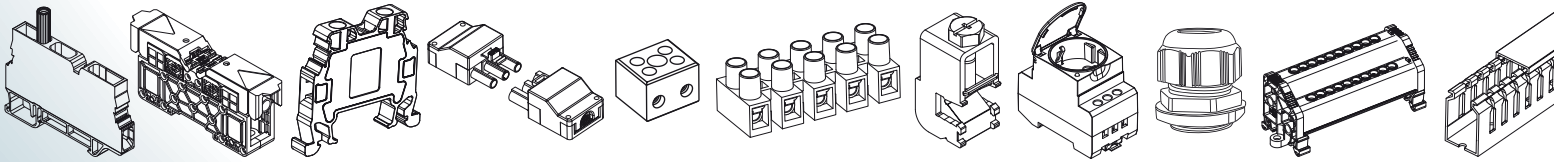
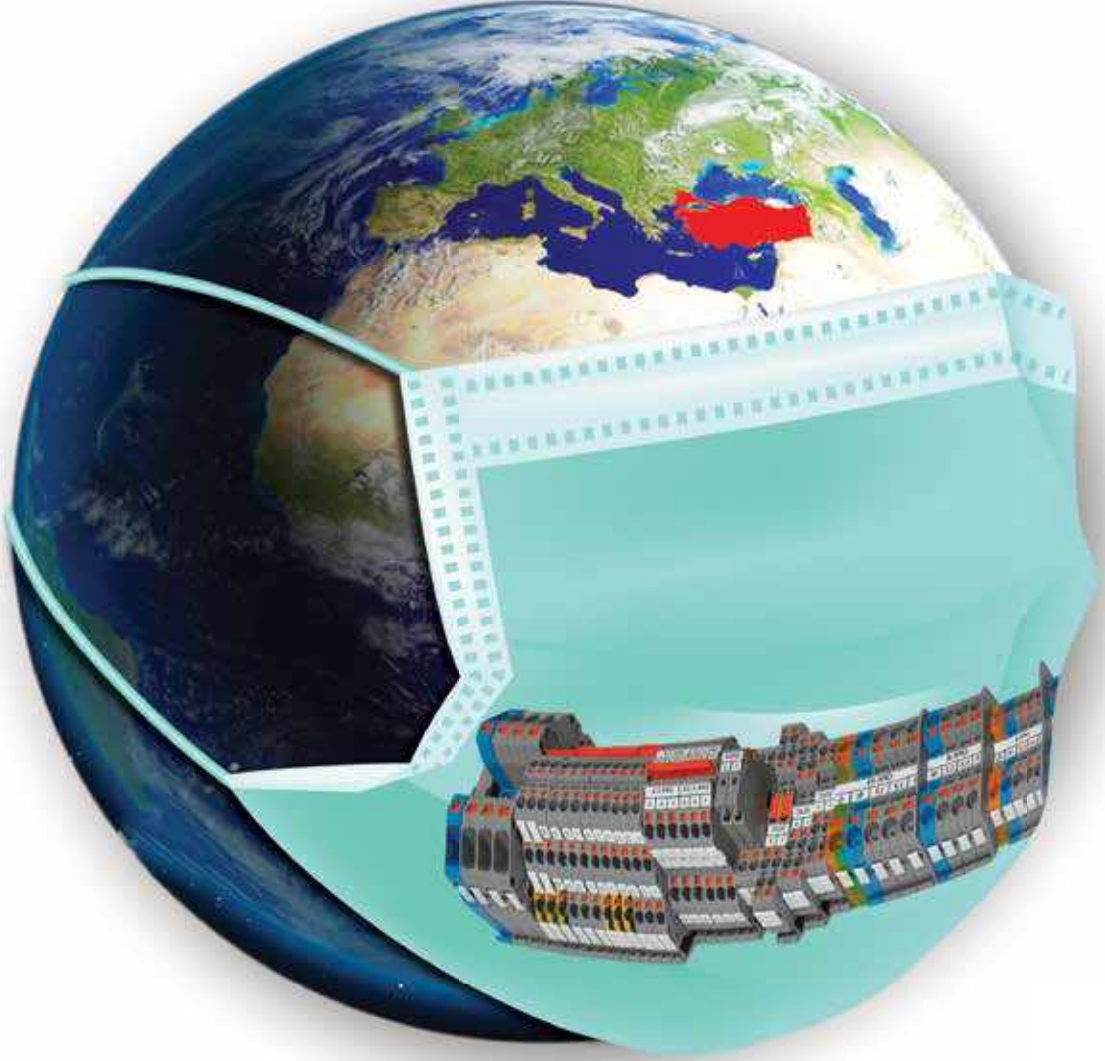

SOLMAZSAN® ONKA yetkili SATICISIDIR

Geçerli listeden iskonto sorunuz.

ÇÖZÜM ORTAKLARIMIZ

Onka®

KARACA®

TAMER
ELEKTRİK

ÇETİNKAYA PANO

GWEST®

SELAY

dp DIZAYN
PANO

kuvel
PANO

Weiller

BAKYAR
EMRE

TURKUVAZ
ELEKTROTEKNİK

KETENCI®

MECİSAN

ELEMENT

Mutlusan
electric

OR-EL®

GLORIOUS

SASSIN

tense®

CHINT

Perpa Ticaret Merkezi A Blok
Kat: 4-5 No: 215 Okmeydanı / İstanbul
Tel: 0212 222 65 70 Fax: 0212 222 65 80
E-mail: info@solmazsan.com.tr
www.solmazsan.com.tr